

TOSHIBA

SERVICE MANUAL

AIR-CONDITIONER SPLIT TYPE

INDOOR UNIT <DIGITAL INVERTER>

Concealed Duct Type

RAV-HM561BTP Series

RAV-HM801BTP Series

RAV-HM901BTP Series

RAV-HM1101BTP Series

RAV-HM1401BTP Series

RAV-HM1601BTP Series

R32



NOTE

A direct current motor is adopted for indoor fan motor in the Concealed Duct Standard Type air conditioner. Caused from its characteristics, a current limit works on the direct current motor. When replacing the high-performance filter or when opening the service board, be sure to stop the fan. If an above action is executed during the fan operation, the protective control works to stop the unit operation, and the check code "P12" may be issued. However it is not a trouble. When the desired operation has finished, be sure to reset the system to clear "P12" error code using the leak breaker of the indoor unit. Then push the operation stop button of the remote controller to return to the usual operation.

CONTENTS

| | |
|---|-----|
| Original instruction | 3 |
| Warning Indications on the Air Conditioner Unit | 5 |
| Precaution for Safety | 6 |
| 1. SPECIFICATIONS | 14 |
| 2. AIR DUCTING WORK | 18 |
| 3. CONSTRUCTION VIEWS (EXTERNAL VIEWS) | 19 |
| 4. WIRING DIAGRAM | 21 |
| 5. SPECIFICATIONS OF ELECTRICAL PARTS | 22 |
| 6. CONTROL BLOCK DIAGRAM | 23 |
| 6-1. Indoor Controller Block Diagram | 23 |
| 6-2. Control Specifications | 25 |
| 6-3. Indoor Print Circuit Board | 43 |
| 7. TROUBLESHOOTING | 45 |
| 7-1. Summary of Troubleshooting | 45 |
| 7-2. Troubleshooting | 47 |
| 8. REPLACEMENT OF SERVICE P.C. BOARD | 65 |
| 9. SETUP AT LOCAL SITE AND OTHERS | 72 |
| 9-1. Indoor Unit | 72 |
| 9-2. Setup at Local Site / Others | 87 |
| 9-3. How to Set up Central Control Address Number | 89 |
| 10. ADDRESS SETUP | 90 |
| 10-1. Address Setup | 90 |
| 10-2. Address Setup & Group Control | 91 |
| 10-3. Address Setup (Manual Setting from Remote Controller) | 94 |
| 11. DETACHMENTS | 97 |
| 12. EXPLODED VIEWS AND PARTS LIST | 103 |

Original instruction

Please read carefully through these instructions that contain important information which complies with the “Machinery” Directive (Directive 2006/42/EC), and ensure that you understand them.

Generic Denomination: Air Conditioner

Definition of Qualified Installer or Qualified Service Person

The air conditioner must be installed, maintained, repaired and removed by a qualified installer or qualified service person.

When any of these jobs is to be done, ask a qualified installer or qualified service person to do them for you.

A qualified installer or qualified service person is an agent who has the qualifications and knowledge described in the table below.

| Agent | Qualifications and knowledge which the agent must have |
|-------------------------------|--|
| Qualified installer (*1) | <ul style="list-style-type: none"> • The qualified installer is a person who installs, maintains, relocates and removes the air conditioners made by Toshiba Carrier Corporation. He or she has been trained to install, maintain, relocate and remove the air conditioners made by Toshiba Carrier Corporation or, alternatively, he or she has been instructed in such operations by an individual or individuals who have been trained and is thus thoroughly acquainted with the knowledge related to these operations. • The qualified installer who is allowed to do the electrical work involved in installation, relocation and removal has the qualifications pertaining to this electrical work as stipulated by the local laws and regulations, and he or she is a person who has been trained in matters relating to electrical work on the air conditioners made by Toshiba Carrier Corporation or, alternatively, he or she has been instructed in such matters by an individual or individuals who have been trained and is thus thoroughly acquainted with the knowledge related to this work. • The qualified installer who is allowed to do the refrigerant handling and piping work involved in installation, relocation and removal has the qualifications pertaining to this refrigerant handling and piping work as stipulated by the local laws and regulations, and he or she is a person who has been trained in matters relating to refrigerant handling and piping work on the air conditioners made by Toshiba Carrier Corporation or, alternatively, he or she has been instructed in such matters by an individual or individuals who have been trained and is thus thoroughly acquainted with the knowledge related to this work. • The qualified installer who is allowed to work at heights has been trained in matters relating to working at heights with the air conditioners made by Toshiba Carrier Corporation or, alternatively, he or she has been instructed in such matters by an individual or individuals who have been trained and is thus thoroughly acquainted with the knowledge related to this work. |
| Qualified service person (*1) | <ul style="list-style-type: none"> • The qualified service person is a person who installs, repairs, maintains, relocates and removes the air conditioners made by Toshiba Carrier Corporation. He or she has been trained to install, repair, maintain, relocate and remove the air conditioners made by Toshiba Carrier Corporation or, alternatively, he or she has been instructed in such operations by an individual or individuals who have been trained and is thus thoroughly acquainted with the knowledge related to these operations. • The qualified service person who is allowed to do the electrical work involved in installation, repair, relocation and removal has the qualifications pertaining to this electrical work as stipulated by the local laws and regulations, and he or she is a person who has been trained in matters relating to electrical work on the air conditioners made by Toshiba Carrier Corporation or, alternatively, he or she has been instructed in such matters by an individual or individuals who have been trained and is thus thoroughly acquainted with the knowledge related to this work. • The qualified service person who is allowed to do the refrigerant handling and piping work involved in installation, repair, relocation and removal has the qualifications pertaining to this refrigerant handling and piping work as stipulated by the local laws and regulations, and he or she is a person who has been trained in matters relating to refrigerant handling and piping work on the air conditioners made by Toshiba Carrier Corporation or, alternatively, he or she has been instructed in such matters by an individual or individuals who have been trained and is thus thoroughly acquainted with the knowledge related to this work. • The qualified service person who is allowed to work at heights has been trained in matters relating to working at heights with the air conditioners made by Toshiba Carrier Corporation or, alternatively, he or she has been instructed in such matters by an individual or individuals who have been trained and is thus thoroughly acquainted with the knowledge related to this work. |

Definition of Protective Gear

When the air conditioner is to be transported, installed, maintained, repaired or removed, wear protective gloves and 'safety' work clothing.

In addition to such normal protective gear, wear the protective gear described below when undertaking the special work detailed in the table below.



Failure to wear the proper protective gear is dangerous because you will be more susceptible to injury, burns, electric shocks and other injuries.

| Work undertaken | Protective gear worn |
|---|---|
| All types of work | Protective gloves 'Safety' working clothing |
| Electrical-related work | Gloves to provide protection for electricians Insulating shoes Clothing to provide protection from electric shock |
| Work done at heights (50 cm or more) | Helmets for use in industry |
| Transportation of heavy objects | Shoes with additional protective toe cap |
| Repair of outdoor unit | Gloves to provide protection for electricians |

The important contents concerned to the safety are described on the product itself and on this Service Manual.



Please read this Service Manual after understanding the described items thoroughly in the following contents (Indications / Illustrated marks), and keep them.

[Explanation of indications]





| Indication | Explanation |
|--|---|
|  DANGER | Indicates contents assumed that an imminent danger causing a death or serious injury of the repair engineers and the third parties when an incorrect work has been executed. |
|  WARNING | Indicates possibilities assumed that a danger causing a death or serious injury of the repair engineers, the third parties, and the users due to troubles of the product after work when an incorrect work has been executed. |
|  CAUTION | Indicates contents assumed that an injury or property damage (*) may be caused on the repair engineers, the third parties, and the users due to troubles of the product after work when an incorrect work has been executed. |

* Property damage: Enlarged damage concerned to property, furniture, and domestic animal / pet

[Explanation of illustrated marks]

| Indication | Explanation |
|---|--|
|  | Indicates prohibited items (Forbidden items to do) The sentences near an illustrated mark describe the concrete prohibited contents. |
|  | Indicates mandatory items (Compulsory items to do) The sentences near an illustrated mark describe the concrete mandatory contents. |
|  | Indicates cautions (Including danger / warning) The sentences or illustration near or in an illustrated mark describe the concrete cautious contents. |





MEANING OF SYMBOLS DISPLAYED ON THE UNIT

| | | |
|---|---|---|
|  | WARNING (Risk of fire) | This mark is for R32 refrigerant only. Refrigerant type is written on nameplate of outdoor unit. In case that refrigerant type is R32, this unit uses a flammable refrigerant. If refrigerant leaks and comes in contact with fire or heating part, it will create harmful gas and there is risk of fire. |
|  | Read the OWNER'S MANUAL carefully before operation. | |
|  | Service personnel are required to carefully read the OWNER'S MANUAL and INSTALLATION MANUAL before operation. | |
|  | Further information is available in the OWNER'S MANUAL, INSTALLATION MANUAL, and the like. | |

Warning Indications on the Air Conditioner Unit

[Confirmation of warning label on the main unit]





Confirm that labels are indicated on the specified positions
 If removing the label during parts replace, stick it as the original.

| Warning indication | Description | | |
|--|----------------|---|---|
|  <table border="1" data-bbox="167 459 818 696"> <tr> <td data-bbox="304 459 818 539" style="text-align: center;">WARNING</td> </tr> <tr> <td data-bbox="304 539 818 696"> <p style="text-align: center;">ELECTRICAL SHOCK HAZARD</p> <p>Disconnect all remote electric power supplies before servicing.</p> </td> </tr> </table> | WARNING | <p style="text-align: center;">ELECTRICAL SHOCK HAZARD</p> <p>Disconnect all remote electric power supplies before servicing.</p> | <p>WARNING</p> <p>ELECTRICAL SHOCK HAZARD Disconnect all remote electric power supplies before servicing.</p> |
| WARNING | | | |
| <p style="text-align: center;">ELECTRICAL SHOCK HAZARD</p> <p>Disconnect all remote electric power supplies before servicing.</p> | | | |
|  <table border="1" data-bbox="167 810 818 1030"> <tr> <td data-bbox="304 810 818 891" style="text-align: center;">WARNING</td> </tr> <tr> <td data-bbox="304 891 818 1030"> <p>Moving parts. Do not operate unit with grille removed. Stop the unit before the servicing.</p> </td> </tr> </table> | WARNING | <p>Moving parts. Do not operate unit with grille removed. Stop the unit before the servicing.</p> | <p>WARNING</p> <p>Moving parts. Do not operate unit with grille removed. Stop the unit before the servicing.</p> |
| WARNING | | | |
| <p>Moving parts. Do not operate unit with grille removed. Stop the unit before the servicing.</p> | | | |
|  <table border="1" data-bbox="167 1151 818 1370"> <tr> <td data-bbox="304 1151 818 1232" style="text-align: center;">CAUTION</td> </tr> <tr> <td data-bbox="304 1232 818 1370"> <p>High temperature parts. You might get burned when removing this panel.</p> </td> </tr> </table> | CAUTION | <p>High temperature parts. You might get burned when removing this panel.</p> | <p>CAUTION</p> <p>High temperature parts. You might get burned when removing this panel.</p> |
| CAUTION | | | |
| <p>High temperature parts. You might get burned when removing this panel.</p> | | | |
|  <table border="1" data-bbox="167 1473 818 1664"> <tr> <td data-bbox="304 1473 818 1554" style="text-align: center;">CAUTION</td> </tr> <tr> <td data-bbox="304 1554 818 1664"> <p>Do not touch the aluminum fins of the unit. Doing so may result in injury.</p> </td> </tr> </table> | CAUTION | <p>Do not touch the aluminum fins of the unit. Doing so may result in injury.</p> | <p>CAUTION</p> <p>Do not touch the aluminum fins of the unit. Doing so may result in injury.</p> |
| CAUTION | | | |
| <p>Do not touch the aluminum fins of the unit. Doing so may result in injury.</p> | | | |
|  <table border="1" data-bbox="167 1778 818 2036"> <tr> <td data-bbox="304 1778 818 1859" style="text-align: center;">CAUTION</td> </tr> <tr> <td data-bbox="304 1859 818 2036"> <p style="text-align: center;">BURST HAZARD</p> <p>Open the service valves before the operation, otherwise there might be the burst.</p> </td> </tr> </table> | CAUTION | <p style="text-align: center;">BURST HAZARD</p> <p>Open the service valves before the operation, otherwise there might be the burst.</p> | <p>CAUTION</p> <p>BURST HAZARD Open the service valves before the operation, otherwise there might be the burst.</p> |
| CAUTION | | | |
| <p style="text-align: center;">BURST HAZARD</p> <p>Open the service valves before the operation, otherwise there might be the burst.</p> | | | |

Precaution for Safety





The manufacturer shall not assume any liability for the damage caused by not observing the description of this manual.







DANGER





| | |
|---|---|
|  Turn off breaker. | <p>Before carrying out the installation, maintenance, repair or removal work, be sure to set the circuit breaker to the OFF position. Otherwise, electric shocks may result.</p> |
| | <p>Before opening the electrical control box cover of the indoor unit or service panel of the outdoor unit, set the circuit breaker to the OFF position. Failure to set the circuit breaker to the OFF position may result in electric shocks through contact with the interior parts. Only a qualified installer (*1) or qualified service person (*1) is allowed to remove the electrical control box cover of the indoor unit or service panel of the outdoor unit and do the work required.</p> |
| | <p>Before starting to repair the outdoor unit fan or fan guard, be absolutely sure to set the circuit breaker to the OFF position, and place a "Work in progress" sign on the circuit breaker.</p> |
| | <p>When cleaning the filter or other parts of the indoor unit, set the circuit breaker to OFF without fail, and place a "Work in progress" sign near the circuit breaker before proceeding with the work.</p> |
|  Electric shock hazard | <p>When checking the electric parts, removing the cover of the electric parts box of Indoor Unit and/or service panel of Outdoor Unit inevitably to determine the failure, use gloves to provide protection for electricians, insulating shoes, clothing to provide protection from electric shock and insulating tools. Be careful not to touch the live part. Electric shock may result. Only "Qualified service person" is allowed to do this work.</p> |
| | <p>Before operating the air conditioner after having completed the work, check that the electrical parts box cover of the indoor unit and service panel of the outdoor unit are closed, and set the circuit breaker to the ON position. You may receive an electric shock if the power is turned on without first conducting these checks.</p> |
|  Execute discharge between terminals. | <p>Even if the circuit breaker has been set to the OFF position before the service panel is removed and the electrical parts are repaired, you will still risk receiving an electric shock. For this reason, short-circuit the high-voltage capacitor terminals to discharge the voltage before proceeding with the repair work. For details on the short-circuiting procedure, refer to the Service Manual. You may receive an electric shock if the voltage stored in the capacitors has not been sufficiently discharged.</p> |
|  Prohibition | <p>Place a "Work in progress" sign near the circuit breaker while the installation, maintenance, repair or removal work is being carried out. There is a danger of electric shocks if the circuit breaker is set to ON by mistake.</p> |
| | <p>When checking the electric parts, removing the cover of the electric parts box of Indoor Unit and/or front panel of Outdoor Unit inevitably to determine the failure, put a sign "Do not enter" around the site before the work. Failure to do this may result in third person getting electric shock.</p> |
|  Stay on protection | <p>If, in the course of carrying out repairs, it becomes absolutely necessary to check out the electrical parts with the electrical parts box cover of one or more of the indoor units and the service panel of the outdoor unit removed in order to find out exactly where the trouble lies, wear insulated heat-resistant gloves, insulated boots and insulated work overalls, and take care to avoid touching any live parts. You may receive an electric shock if you fail to heed this warning. Only qualified service person (*1) is allowed to do this kind of work.</p> |

WARNING

| | |
|--|--|
|  General | <p>Before starting to repair the air conditioner, read carefully through the Service Manual, and repair the air conditioner by following its instructions.</p> |
| | <p>Only qualified service person (*1) is allowed to repair the air conditioner. Repair of the air conditioner by unqualified person may give rise to a fire, electric shocks, injury, water leaks and/or other problems.</p> |
| | <p>Only a qualified installer (*1) or qualified service person (*1) is allowed to carry out the electrical work of the air conditioner. Under no circumstances must this work be done by an unqualified individual since failure to carry out the work properly may result in electric shocks and/or electrical leaks.</p> |

| | |
|---|---|
|  General | <p>Electrical wiring work shall be conducted according to law and regulation in the community and Installation manual. Failure to do so may result in electrocution or short circuit.</p> |
| | <p>To connect the electrical wires, repair the electrical parts or undertake other electrical jobs, wear gloves to provide protection for electricians, insulating shoes and clothing to provide protection from electric shocks. Failure to wear this protective gear may result in electric shocks.</p> |
| | <p>Inside the air conditioner are high-voltage areas and rotating parts. Due to the danger of electric shocks or of your fingers or physical objects becoming trapped in the rotating parts, do not remove the electrical control box cover of the indoor unit or service panel of the outdoor unit. When work involving the removal of these parts is required, contact a qualified installer or a qualified service person.</p> |
| | <p>Use wiring that meets the specifications in the Installation Manual and the stipulations in the local regulations and laws. Use of wiring which does not meet the specifications may give rise to electric shocks, electrical leakage, smoking and/or a fire.</p> |
| | <p>Only a qualified installer (*1) or qualified service person (*1) is allowed to undertake work at heights using a stand of 50 cm or more or to remove the electrical control box cover of the indoor unit to undertake work.</p> |
| | <p>When working at heights, use a ladder which complies with the ISO 14122 standard, and follow the procedure in the ladders instructions. Also wear a helmet for use in industry as protective gear to undertake the work.</p> |
| | <p>Before working at heights, put a sign in place so that no-one will approach the work location, before proceeding with the work. Parts and other objects may fall from above, possibly injuring a person below. While carrying out the work, wear a helmet for protection from falling objects.</p> |
| | <p>Before opening the suction board cover, set the circuit breaker to the OFF position. Failure to set the circuit breaker to the OFF position may result in injury through contact with the rotation parts. Only a qualified installer (*1) or qualified service person (*1) is allowed to remove the suction board cover and do the work required.</p> |
| | <p>Do not touch the aluminum fin of the unit. You may injure yourself if you do so. If the fin must be touched for some reason, first put on protective gloves and safety work clothing, and then proceed.</p> |
| | <p>Use forklift to carry in the air conditioner units and use winch or hoist at installation of them.</p> |
| | <p>When the air conditioner is to be transported, installed, maintained, repaired or removed, wear protective gloves and 'safety' work clothing.</p> |
| | <p>When transporting the air conditioner, do not take hold of the bands around the packing carton. You may injure yourself if the bands should break.</p> |
| | <p>When the first filter comes out without connected to the other one, insert it once more to connect the two filters together and pull out them as connected. Do not insert hands to take out the second filter. You may injure Yourself.</p> |
| <p>This air conditioner has passed the pressure test as specified in IEC 60335-2-40 Annex EE.</p> | |
|  Check earth wires. | <p>Before troubleshooting or repair work, check the earth wire is connected to the earth terminals of the main unit, otherwise an electric shock is caused when a leak occurs.If the earth wire is not correctly connected, contact an electric engineer for rework.</p> |
| | <p>After completing the repair or relocation work, check that the ground wires are connected properly.</p> |
| | <p>Connect earth wire. (Grounding work) Incomplete grounding causes an electric shock. Do not connect ground wires to gas pipes, water pipes, and lightning rods or ground wires for telephone wires.</p> |
|  Prohibition of modification. | <p>Do not modify the products.Do not also disassemble or modify the parts. It may cause a fire, electric shock or injury.</p> |
|  Use specified parts. | <p>When any of the electrical parts are to be replaced, ensure that the replacement parts satisfy the specifications given in the Service Manual (or use the parts contained on the parts list in the Service Manual). Use of any parts which do not satisfy the required specifications may give rise to electric shocks,smoking and/or a fire.</p> |
|  Do not bring a child close to the equipment. | <p>If, in the course of carrying out repairs, it becomes absolutely necessary to check out the electrical parts with the electrical parts box cover of one or more of the indoor units and the service panel of the outdoor unit removed in order to find out exactly where the trouble lies, place "Keep out" signs around the work site before proceeding. Third-party individuals may enter the work site and receive electric shocks if this warning is not heeded.</p> |

| | |
|---|---|
|  Insulating measures | Connect the cut-off lead wires with crimp contact, etc, put the closed end side upward and then apply a water-cut method, otherwise a leak or production of fire is caused at the users' side. |
|  No fire | When performing repairs using a gas burner, replace the refrigerant with nitrogen gas because the oil that coats the pipes may otherwise burn. When repairing the refrigerating cycle, take the following measures. 1) Be attentive to fire around the cycle. When using a gas stove, etc, be sure to put out fire before work; otherwise the oil mixed with refrigerant gas may catch fire. 2) Do not use a welder in the closed room. When using it without ventilation, carbon monoxide poisoning may be caused. 3) Do not bring inflammables close to the refrigerant cycle, otherwise fire of the welder may catch the inflammables. |
|  Refrigerant | The refrigerant used by this air conditioner is the R32. Check the used refrigerant name and use tools and materials of the parts which match with it. For the products which use R32 refrigerant, the refrigerant name is indicated at a position on the outdoor unit where is easy to see. To prevent miss-charging, the route of the service port is changed from one of the former R22. Do not use any refrigerant different from the one specified for complement or replacement. Otherwise, abnormally high pressure may be generated in the refrigeration cycle, which may result in a failure or explosion of the product or an injury to your body. For an air conditioner which uses R32, never use other refrigerant than R32. For an air conditioner which uses other refrigerant (R22, etc.), never use R32. If different types of refrigerant are mixed, abnormal high pressure generates in the refrigerating cycle and an injury due to breakage may be caused. Do not charge refrigerant additionally. If charging refrigerant additionally when refrigerant gas leaks, the refrigerant composition in the refrigerating cycle changes resulted in change of air conditioner characteristics or refrigerant over the specified standard amount is charged and an abnormal high pressure is applied to the inside of the refrigerating cycle resulted in cause of breakage or injury. Therefore if the refrigerant gas leaks, recover the refrigerant in the air conditioner, execute vacuuming, and then newly recharge the specified amount of liquid refrigerant. In this time, never charge the refrigerant over the specified amount. When recharging the refrigerant in the refrigerating cycle, do not mix the refrigerant or air other than R32 into the specified refrigerant. If air or others is mixed with the refrigerant, abnormal high pressure generates in the refrigerating cycle resulted in cause of injury due to breakage. After installation work, check the refrigerant gas does not leak. If the refrigerant gas leaks in the room, poisonous gas generates when gas touches to fire such as fan heater, stove or cocking stove though the refrigerant gas itself is innocuous. Never recover the refrigerant into the outdoor unit. When the equipment is moved or repaired, be sure to recover the refrigerant with recovering device. The refrigerant cannot be recovered in the outdoor unit; otherwise a serious accident such as breakage or injury is caused. |
|  Assembly/ Cabling | After repair work, surely assemble the disassembled parts, and connect and lead the removed wires as before. Perform the work so that the cabinet or panel does not catch the inner wires. If incorrect assembly or incorrect wire connection was done, a disaster such as a leak or fire is caused at user's side. |
|  Insulator check | After the work has finished, be sure to use an insulation tester set (500V Megger) to check the resistance is 1MΩ or more between the charge section and the non-charge metal section (Earth position). If the resistance value is low, a disaster such as a leak or electric shock is caused at user's side. |
|  Ventilation | When the refrigerant gas leaks during work, execute ventilation. If the refrigerant gas touches to a fire, poisonous gas generates. A case of leakage of the refrigerant and the closed room full with gas is dangerous because a shortage of oxygen occurs. Be sure to execute ventilation. If refrigerant gas has leaked during the installation work, ventilate the room immediately. If the leaked refrigerant gas comes in contact with fire, noxious gas may generate. After installation work, check the refrigerant gas does not leak. If the refrigerant gas leaks in the room, poisonous gas generates when gas touches to fire such as fan heater, stove or cocking stove though the refrigerant gas itself is innocuous. |

| | |
|---|---|
|  Compulsion | <p>When the refrigerant gas leaks, find up the leaked position and repair it surely. If the leaked position cannot be found up and the repair work is interrupted, pump-down and tighten the service valve, otherwise the refrigerant gas may leak into the room. The poisonous gas generates when gas touches to fire such as fan heater, stove or cooking stove though the refrigerant gas itself is innocuous. When installing equipment which includes a large amount of charged refrigerant such as a multi air conditioner in a sub-room, it is necessary that the density does not the limit even if the refrigerant leaks. If the refrigerant leaks and exceeds the limit density, an accident of shortage of oxygen is caused.</p> |
| | <p>Tighten the flare nut with a torque wrench in the specified manner. Excessive tighten of the flare nut may cause a crack in the flare nut after a long period, which may result in refrigerant leakage.</p> |
| | <p>Nitrogen gas must be used for the airtight test.</p> |
| | <p>The charge hose must be connected in such a way that it is not slack.</p> |
| | <p>For the installation/moving/reinstallation work, follow to the Installation Manual. If an incorrect installation is done, a trouble of the refrigerating cycle, water leak, electric shock or fire is caused.</p> |
|  Check after repair | <p>Once the repair work has been completed, check for refrigerant leaks, and check the insulation resistance and water drainage. Then perform a trial run to check that the air conditioner is running properly.</p> |
| | <p>After repair work has finished, check there is no trouble. If check is not executed, a fire, electric shock or injury may be caused. For a check, turn off the power breaker.</p> |
| | <p>After repair work (installation of front panel and cabinet) has finished, execute a test run to check there is no generation of smoke or abnormal sound. If check is not executed, a fire or an electric shock is caused. Before test run, install the front panel and cabinet.</p> |
|  Do not operate the unit with the valve closed. | <p>Check the following matters before a test run after repairing piping. Connect the pipes surely and there is no leak of refrigerant. The valve is opened. Running the compressor under condition that the valve closes causes an abnormal high pressure resulted in damage of the parts of the compressor and etc. and moreover if there is leak of refrigerant at connecting section of pipes, the air is suctioned and causes further abnormal high pressure resulted in burst or injury.</p> |
|  Check after reinstallation | <p>Only a qualified installer (*1) or qualified service person (*1) is allowed to relocate the air conditioner. It is dangerous for the air conditioner to be relocated by an unqualified individual since a fire, electric shocks, injury, water leakage, noise and/or vibration may result.</p> |
| | <p>Check the following items after reinstallation. 1) The earth wire is correctly connected. 2) The power cord is not caught in the product. 3) There is no inclination or unsteadiness and the installation is stable. If check is not executed, a fire, an electric shock or an injury is caused.</p> |
| | <p>When carrying out the pump-down work shut down the compressor before disconnecting the refrigerant pipe. Disconnecting the refrigerant pipe with the service valve left open and the compressor still operating will cause air, etc. to be sucked in, raising the pressure inside the refrigeration cycle to an abnormally high level, and possibly resulting in reputing, injury, etc.</p> |
|  Cooling check | <p>When the service panel of the outdoor unit is to be opened in order for the compressor or the area around this part to be repaired immediately after the air conditioner has been shut down, set the circuit breaker to the OFF position, and then wait at least 10 minutes before opening the service panel. If you fail to heed this warning, you will run the risk of burning yourself because the compressor pipes and other parts will be very hot to the touch. In addition, before proceeding with the repair work, wear the kind of insulated heat-resistant gloves designed to protect electricians.</p> |
| | <p>When the service panel of the outdoor unit is to be opened in order for the fan motor, reactor, inverter or the areas around these parts to be repaired immediately after the air conditioner has been shut down, set the circuit breaker to the OFF position, and then wait at least 10 minutes before opening the service panel. If you fail to heed this warning, you will run the risk of burning yourself because the fan motor, reactor, inverter heat sink and other parts will be very hot to the touch. In addition, before proceeding with the repair work, wear the kind of insulated heat-resistant gloves designed to protect electricians.</p> |

| | |
|--|--|
|  Installation | Only a qualified installer or service person is allowed to do installation work. Inappropriate installation may result in water leakage, electric shock or fire. |
| | Before starting to install the air conditioner, read carefully through the Installation Manual, and follow its instructions to install the air conditioner. |
| | If the unit is installed in a small room, take appropriate measures to prevent the refrigerant from exceeding the limit concentration even if it leaks. Consult the dealer from whom you purchased the air conditioner when you implement the measures. Accumulation of highly-concentrated refrigerant may cause an oxygen deficiency accident. |
| | Do not install the air conditioner in a location that may be subject to a risk of exposure to a combustible gas. If a combustible gas leaks and becomes concentrated around the unit, a fire may occur. |
| | Install the indoor unit at least 2.5 m above the floor level since otherwise the users may injure themselves or receive electric shocks if they poke their fingers or other objects into the indoor unit while the air conditioner is running. |
| | Install a circuit breaker that meets the specifications in the installation manual and the stipulations in the local regulations and laws. |
| | Install the circuit breaker where it can be easily accessed by the agent. |
| | Do not place any combustion appliance in a place where it is directly exposed to the wind of air conditioner, otherwise it may cause imperfect combustion. |
| | When mounting the rails, push them until the 3 latches click. |
| Insert the filters into the direction which the arrows, carved on the filters, show. (2 filters are identical) | |

Explanations given to user

- If you have discovered that the fan grille is damaged, do not approach the outdoor unit but set the circuit breaker to the OFF position, and contact a qualified service person to have the repairs done. Do not set the circuit breaker to the ON position until the repairs are completed.

Relocation

- Only a qualified installer (*1) or qualified service person (*1) is allowed to relocate the air conditioner. It is dangerous for the air conditioner to be relocated by an unqualified individual since a fire, electric shocks, injury, water leakage, noise and/or vibration may result.
- When carrying out the pump-down work shut down the compressor before disconnecting the refrigerant pipe. Disconnecting the refrigerant pipe with the service valve left open and the compressor still operating will cause air, etc. to be sucked in, raising the pressure inside the refrigeration cycle to an abnormally high level, and possibly resulting in reputing, injury, etc.

(*1) Refer to the "Definition of Qualified Installer or Qualified Service Person."

Declaration of Conformity

Manufacturer: Toshiba Carrier (Thailand) Co., Ltd.
144/9 Moo 5, Bangkadi Industrial Park, Tivanon road, Tambol Bangkadi,
Amphur Muang, Pathumthani 12000, Thailand

TCF holder: TOSHIBA CARRIER EUROPE S.A.S
Route de Thil 01120 Montluel FRANCE

Hereby declares that the machinery described below:

Generic Denomination: Air Conditioner

| | | |
|---------------|-----------------|------------------|
| Model / type: | RAV-HM561BTP-E | RAV-HM561BTP-TR |
| | RAV-HM801BTP-E | RAV-HM801BTP-TR |
| | RAV-HM901BTP-E | RAV-HM1101BTP-TR |
| | RAV-HM1101BTP-E | RAV-HM1401BTP-TR |
| | RAV-HM1401BTP-E | RAV-HM1601BTP-TR |
| | RAV-HM1601BTP-E | |

Commercial name: Digital Inverter Series / Super Digital Inverter Series Air Conditioner

Complies with the provisions of the Machinery Directive (Directive 2006/42/EC) and the regulations transposing into national law

Name: Masaru Takeyama
Position: GM, Quality Assurance Dept.
Date: 5 April, 2022
Place Issued: Thailand

NOTE

This declaration becomes invalid if technical or operational modifications are introduced without the manufacturer's consent.

Declaration of Conformity

Manufacturer: Toshiba Carrier (Thailand) Co., Ltd.
144/9 Moo 5, Bangkadi Industrial Park, Tivanon road, Tambol Bangkadi,
Amphur Muang, Pathumthani 12000, Thailand

TCF holder: TOSHIBA CARRIER UK LTD.
Porsham Close Belliver Industrial Estate Roborough Plymouth Devon
PL6 7DB United Kingdom

Hereby declares that the machinery described below:

Generic Denomination: Air Conditioner

Model / type: RAV-HM561BTP-E
RAV-HM801BTP-E
RAV-HM901BTP-E
RAV-HM1101BTP-E
RAV-HM1401BTP-E
RAV-HM1601BTP-E

Commercial name: Digital Inverter Series / Super Digital Inverter Series Air Conditioner

Complies with the provisions of the Supply of Machinery (Safety) Regulations 2008

Name: Masaru Takeyama
Position: GM, Quality Assurance Dept.
Date: 5 April, 2022
Place Issued: Thailand

NOTE

This declaration becomes invalid if technical or operational modifications are introduced without the manufacturer's consent.

Specifications

| Model | Sound pressure level (dBA) | | Weight (kg) |
|------------------|----------------------------|---------|-------------|
| | Cooling | Heating | |
| RAV-HM561BTP-E | * | * | 23 |
| RAV-HM801BTP-E | * | * | 31 |
| RAV-HM901BTP-E | * | * | 41 |
| RAV-HM1101BTP-E | * | * | 41 |
| RAV-HM1401BTP-E | * | * | 41 |
| RAV-HM1601BTP-E | * | * | 41 |
| RAV-HM561BTP-TR | * | * | 23 |
| RAV-HM801BTP-TR | * | * | 31 |
| RAV-HM1101BTP-TR | * | * | 41 |
| RAV-HM1401BTP-TR | * | * | 41 |
| RAV-HM1601BTP-TR | * | * | 41 |

* Under 70 dBA

1. SPECIFICATIONS

| Model | Indoor unit | | 561BTP-E(-TR) | | 801BTP-E(-TR) | 901BTP-E |
|--------------------------------------|--------------------------------------|------------------------|--|---------------|----------------|----------------|
| | Outdoor unit | | 561ATP-E(-TR) | 562ATP-E(TR) | 801ATP-E(-TR) | 901ATP-E(-TR) |
| Cooling Capacity | | (kW) | 5.0 | 5.0 | 6.7 | 8.0 |
| Heating Capacity | | (kW) | 5.3 | 5.3 | 7.7 | 9.0 |
| Power Supply | | | 1 phase 220V-240V, 50Hz | | | |
| Electrical Characteristics | Cooling | Running current (A) | 8.58 - 7.86 | 8.58 - 7.86 | 11.20 - 10.20 | 12.63 - 11.58 |
| | | Power consumption (kW) | 1.830 | 1.830 | 2.380 | 2.667 |
| | | Power factor (%) | 97 | 97 | 97 | 96 |
| | | EER | 2.73 | 2.73 | 2.82 | 3.00 |
| | | SEER | 5.28 | 5.80 | 5.20 | 6.10 |
| | Energy star rating ※※ | A | A+ | A | A++ | |
| | Heating | Running current (A) | 7.59 - 6.96 | 7.59 - 6.96 | 10.90 - 9.97 | 12.50 - 11.50 |
| | | Power consumption (kW) | 1.620 | 1.620 | 2.320 | 2.650 |
| | | Power factor (%) | 97 | 97 | 97 | 96 |
| | | COP | 3.27 | 3.27 | 3.32 | 3.40 |
| | | SCOP | 4.08 | 4.08 | 4.13 | 4.60 |
| Energy star rating ※※ | A+ | A+ | A+ | A++ | | |
| Maximum current | | (A) | 15.5 | 15.5 | 15.5 | 17.0 |
| Appearance | Main unit | | Zinc hot dipping steel plate | | | |
| | Spigot flange (Sold separately) | | TCB-SF56C6BPE | | TCB-SF80C6BPE | TCB-SF160C6BPE |
| Outer dimension | Main unit | Height (mm) | 275 | 275 | 275 | 275 |
| | | Width (mm) | 700 | 700 | 1000 | 1400 |
| | | Depth (mm) | 750 | 750 | 750 | 750 |
| | Spigot flange (Sold separately) | Height (mm) | 263 | 263 | 263 | 263 |
| | | Width (mm) | 684 | 684 | 984 | 1384 |
| | | Depth (mm) | 174 | 174 | 174 | 174 |
| Total weight | Main unit (kg) | | 23 | 23 | 31 | 41 |
| | Spigot flange (Sold separately) (kg) | | 2.5 | 2.5 | 3.5 | 5 |
| Heat exchanger | | | Finned tube | | | |
| Fan unit | Fan | | Centrifugal fan (multi blade) | | | |
| | Standard air flow | H/M/L (m3/min) | 13.3/10.5/8.0 | 13.3/10.5/8.0 | 20.0/15.5/12.5 | 28.3/21.7/16.7 |
| | Motor (W) | | 150 | 150 | 150 | 250 |
| Air filter | | | Standard filter attached (long life filter) | | | |
| Controller (packed with indoor unit) | | | - | | | |
| Controller (sold separately) | | | RBC-ASCU11-E, RBC-AMT32E, RBC-AS21E2, RBC-AMS41E, RBC-AMS51E | | | |
| Sound pressure level | | H/M/L (dB·A) | 33/29/25 | 33/29/25 | 34/30/26 | 37/33/30 |
| Sound power level | | H/M/L (dB·A) | 48/44/40 | 48/44/40 | 49/45/41 | 52/48/45 |
| Connecting pipe | Gas side (mm) | | 12.7 | 12.7 | 15.9 | 15.9 |
| | Liquid side (mm) | | 6.4 | 6.4 | 9.5 | 9.5 |
| | Drain port (mm) | | VP25 | | | |

※IEC Standard ※※AS Standard

| Model | Indoor unit | | 1101BTP-E(-TR) | | 1401BTP-E(-TR) | | 1601BTP-E(-TR) | |
|--------------------------------------|--------------------------------------|------------------------|--|-----------------|----------------|-----------------|----------------|-----------------|
| | RAV-HM | RAV-GM | 1101ATP-E(-TR) | 1101AT8P-E(-TR) | 1401ATP-E(-TR) | 1401AT8P-E(-TR) | 1601ATP-E(-TR) | 1601AT8P-E(-TR) |
| Cooling Capacity | | (kW) | 9.5 | 9.5 | 12.1 | 12.1 | 14.0 | 14.0 |
| Heating Capacity | | (kW) | 11.2 | 11.2 | 13.0 | 13.0 | 16.0 | 16.0 |
| Power Supply | | | 1 phase 220V-240V, 50Hz / 3 phase 380V-415V, 50Hz | | | | | |
| Electrical Characteristics | Cooling | Running current (A) | 14.50 - 13.20 | 4.85 - 4.44 | 21.40 - 19.60 | 7.15 - 6.55 | 24.03 - 22.03 | 8.29 - 7.59 |
| | | Power consumption (kW) | 2.990 | 2.990 | 4.420 | 4.420 | 5.128 | 5.128 |
| | | Power factor (%) | 94 | 94 | 94 | 94 | 97 | 94 |
| | | EER | 3.18 | 3.18 | 2.74 | 2.74 | 2.73 | 2.73 |
| | | SEER | 5.28 | 5.28 | 5.36 | 5.36 | 5.30 | 5.30 |
| | Energy star rating ※※ | A | A | - | - | - | - | |
| | Heating | Running current (A) | 14.50 - 13.30 | 4.85 - 4.44 | 17.40 - 15.95 | 5.80 - 5.30 | 21.99 - 20.15 | 7.58 - 6.94 |
| | | Power consumption (kW) | 2.990 | 2.990 | 3.600 | 3.600 | 4.692 | 4.692 |
| | | Power factor (%) | 94 | 94 | 94 | 94 | 97 | 94 |
| | | COP | 3.75 | 3.75 | 3.61 | 3.61 | 3.41 | 3.41 |
| SCOP | | 4.19 | 4.19 | 4.19 | 4.19 | 3.90 | 3.90 | |
| Energy star rating ※※ | A+ | A+ | - | - | - | - | | |
| Maximum current (A) | | 22.80 | 14.10 | 22.80 | 14.10 | 29.00 | 16.10 | |
| Appearance | Main unit | | Zinc hot dipping steel plate | | | | | |
| | Spigot flange (Sold separately) | | TCB-SF160C6BPE | | TCB-SF160C6BPE | | TCB-SF160C6BPE | TCB-SF160C6BPE |
| Outer dimension | Main unit | Height (mm) | 275 | 275 | 275 | 275 | 275 | 275 |
| | | Width (mm) | 1400 | 1400 | 1400 | 1400 | 1400 | 1400 |
| | | Depth (mm) | 750 | 750 | 750 | 750 | 750 | 750 |
| | Spigot flange (Sold separately) | Height (mm) | 263 | 263 | 263 | 263 | 263 | 263 |
| | | Width (mm) | 1384 | 1384 | 1384 | 1384 | 1384 | 1384 |
| | | Depth (mm) | 174 | 174 | 174 | 174 | 174 | 174 |
| Total weight | Main unit (kg) | 41 | 41 | 41 | 41 | 41 | 41 | |
| | Spigot flange (Sold separately) (kg) | 5 | 5 | 5 | 5 | 5 | 5 | |
| Heat exchanger | | | Finned tube | | | | | |
| Fan unit | Fan | | Centrifugal fan (multi blade) | | | | | |
| | Standard air flow | H/M/L (m3/min) | 35.0/27.5/21.0 | 35.0/27.5/21.0 | 35.0/27.5/21.0 | 35.0/27.5/21.0 | 35.0/27.5/21.0 | 35.0/27.5/21.0 |
| | Motor (W) | | 250 | 250 | 250 | 250 | 250 | 250 |
| Air filter | | | Standard filter attached (long life filter) | | | | | |
| Controller (packed with indoor unit) | | | - | | | | | |
| Controller (sold separately) | | | RBC-ASCU11-E, RBC-AMT32E, RBC-AS21E2, RBC-AMS41E, RBC-AMSS1E | | | | | |
| Sound pressure level | H/M/L (dB-A) | 40/36/33 | 40/36/33 | 40/36/33 | 40/36/33 | 40/36/33 | 40/36/33 | |
| Sound power level | H/M/L (dB-A) | 55/51/48 | 55/51/48 | 55/51/48 | 55/51/48 | 55/51/48 | 55/51/48 | |
| Connecting pipe | Gas side (mm) | 15.9 | 15.9 | 15.9 | 15.9 | 15.9 | 15.9 | |
| | Liquid side (mm) | 9.5 | 9.5 | 9.5 | 9.5 | 9.5 | 9.5 | |
| | Drain port (mm) | | VP25 | | | | | |

※IEC Standard ※※AS Standard

• Refrigerant (R32)

This air conditioner adopts a refrigerant HFC (R32) which does not deplete the ozone layer.

1. Safety Caution Concerned to Refrigerant R32

The pressure of R32 is high 1.6 times of that of the former refrigerant (R22).

Accompanied with change of refrigerant, the refrigerating oil has been also changed.

Therefore, be sure that water, dust, the former refrigerant or the former refrigerating oil is not mixed into the refrigerating cycle of the air conditioner with refrigerant R32 during installation work or service work. If an incorrect work or incorrect service is performed, there is a possibility to cause a serious accident. Use the tools and materials exclusive to R32 to purpose a safe work.

2. Cautions on Installation/Service

1) Do not mix the other refrigerant or refrigerating oil.

For the tools exclusive to R32 shapes of all the joints including the service port differ from those of the former refrigerant in order to prevent mixture of them.

2) As the use pressure of the refrigerant R32 is high, use material thickness of the pipe and tools which are specified for R32.

3) In the installation time, use clean pipe materials and work with great attention so that water and others do not mix in because pipes are affected by impurities such as water, oxide scales, oil, etc.

Use the clean pipes.

Be sure to brazing with flowing nitrogen gas. (Never use gas other than nitrogen gas.)

4) For the earth protection, use a vacuum pump for air purge.

5) R32 refrigerant is azeotropic mixture type refrigerant.

Therefore use liquid type to charge the refrigerant. (If using gas for charging, composition of the refrigerant changes and then characteristics of the air conditioner change.)

3. Pipe Materials

For the refrigerant pipes, copper pipe and joints are mainly used.

It is necessary to select the most appropriate pipes to conform to the standard.

Use clean material in which impurities adhere inside of pipe or joint to a minimum.

1) Copper pipe

<Piping>

The pipe thickness, flare finishing size, flare nut and others differ according to a refrigerant type.

When using a long copper pipe for R32 it is recommended to select "Copper or copper-base pipe without seam" and one with bonded oil amount 40mg/10m or less.

Also do not use crushed, deformed, discolored (especially inside) pipes.

(Impurities cause clogging of expansion valves and capillary tubes.)

<Flare nut>

Use the flare nuts which are attached to the air conditioner unit.

2) Joint

The flare joint and socket joint are used for joints of the copper pipe.

The joints are rarely used for installation of the air conditioner. However clear impurities when using them.

4. Tools

1. Required Tools for R32

Mixing of different types of oil may cause a trouble such as generation of sludge, clogging of capillary, etc. Accordingly, the tools to be used are classified into the following three types.

- 1) Tools exclusive for R32 (Those which cannot be used for conventional refrigerant (R22))
- 2) Tools exclusive for R32 but can be also used for conventional refrigerant (R22)
- 3) Tools commonly used for R32 and for conventional refrigerant (R22)

The table below shows the tools exclusive for R32 and their interchangeability.

Tools exclusive for R32 (The following tools for R32 are required.)

Tools whose specifications are changed for R32 and their interchangeability

| No. | Used tool | Usage | R32 air conditioner installation | | Conventional air conditioner installation |
|-----|--|--|--|--|---|
| | | | Existence of new equipment for R32 | Whether conven- tional equipment can be used | Whether conventional equipment can be used |
| ① | Flare tool | Pipe flaring | Yes | *(Note) | Yes |
| ② | Copper pipe gauge for adjusting projection margin | Flaring by conventional flare tool | Yes | *(Note) | *(Note) |
| ③ | Torque wrench | Tightening of flare nut | Yes | No | No |
| ④ | Gauge manifold | Evacuating, refrigerant charge, run check, etc. | Yes | No | No |
| ⑤ | Charge hose | | | | |
| ⑥ | Vacuum pump adapter | Vacuum evacuating | Yes | No | Yes |
| ⑦ | Electronic balance for refrigerant charging | Refrigerant charge | Yes | Yes | Yes |
| ⑧ | Refrigerant cylinder | Refrigerant charge | Yes | No | No |
| ⑨ | Leakage detector | Gas leakage check | Yes | No | Yes |

(Note) When flaring is carried out for R32 using the conventional flare tools, adjustment of projection margin is necessary. For this adjustment, a copper pipe gauge, etc. are necessary.

General tools (Conventional tools can be used.)

In addition to the above exclusive tools, the following equipments which serve also for R22 are necessary as the general tools.

- | | |
|---|---|
| <ol style="list-style-type: none"> 1) Vacuum pump. Use vacuum pump by attaching vacuum pump adapter. 2) Torque wrench 3) Pipe cutter 4) Reamer 5) Pipe bender 6) Level vial | <ol style="list-style-type: none"> 7) Screwdriver (+, -) 8) Spanner or Monkey wrench 9) Hole core drill 10) Hexagon wrench (Opposite side 4mm) 11) Tape measure 12) Metal saw |
|---|---|

Also prepare the following equipments for other installation method and run check.

- | | |
|--|---|
| <ol style="list-style-type: none"> 1) Clamp meter 2) Thermometer | <ol style="list-style-type: none"> 3) Insulation resistance tester (Megger) 4) Electroscope |
|--|---|

2. AIR DUCTING WORK

Static Pressure Characteristics

HM56

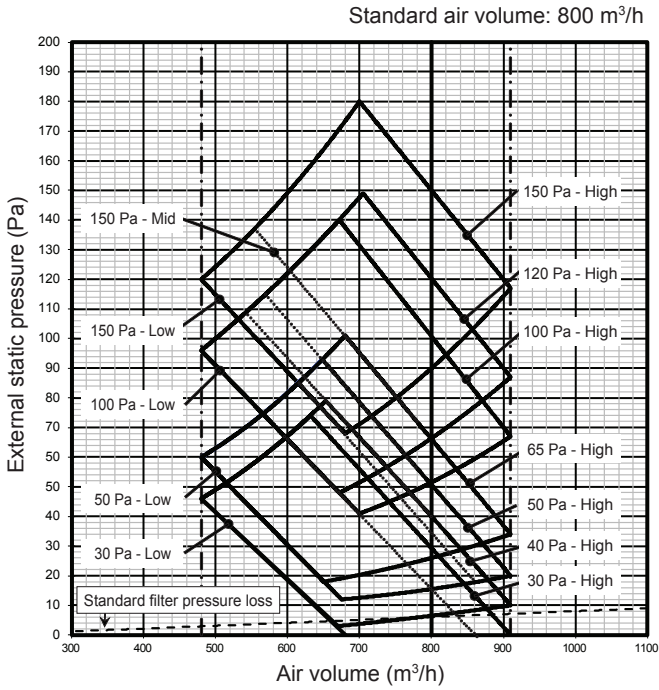

HM80

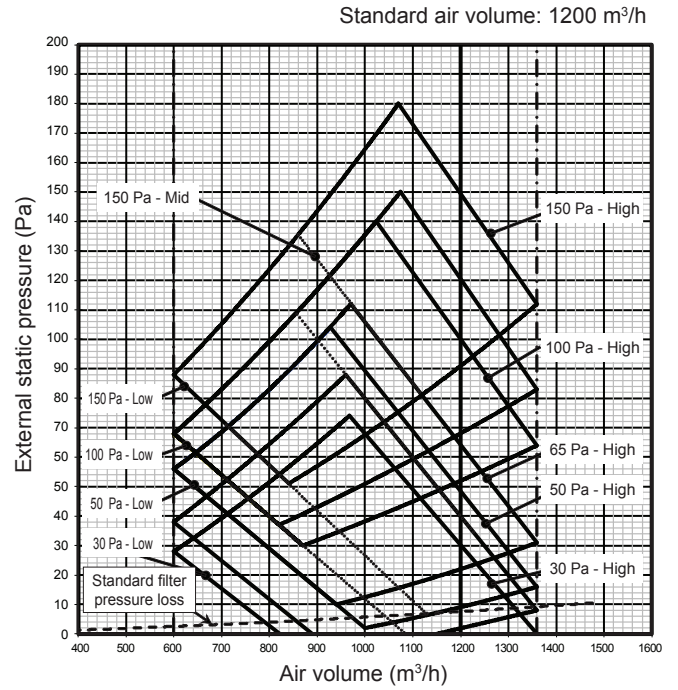

HM90

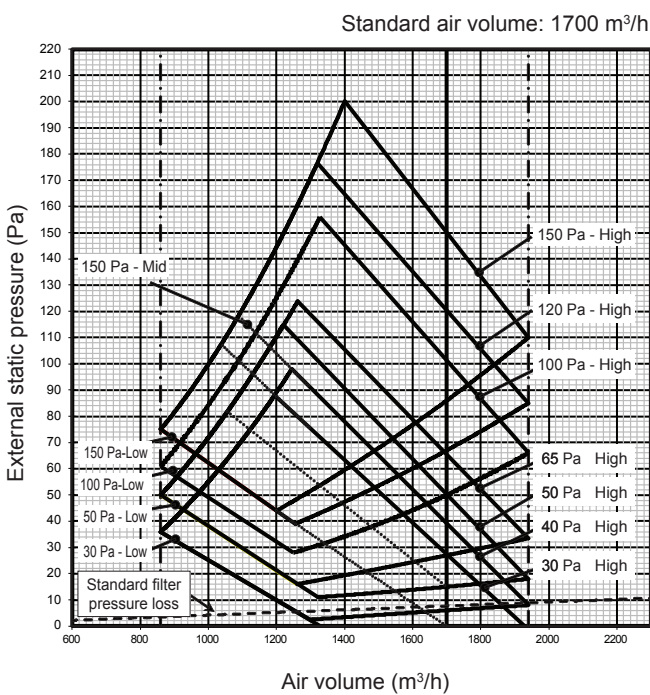

HM110, 140, 160

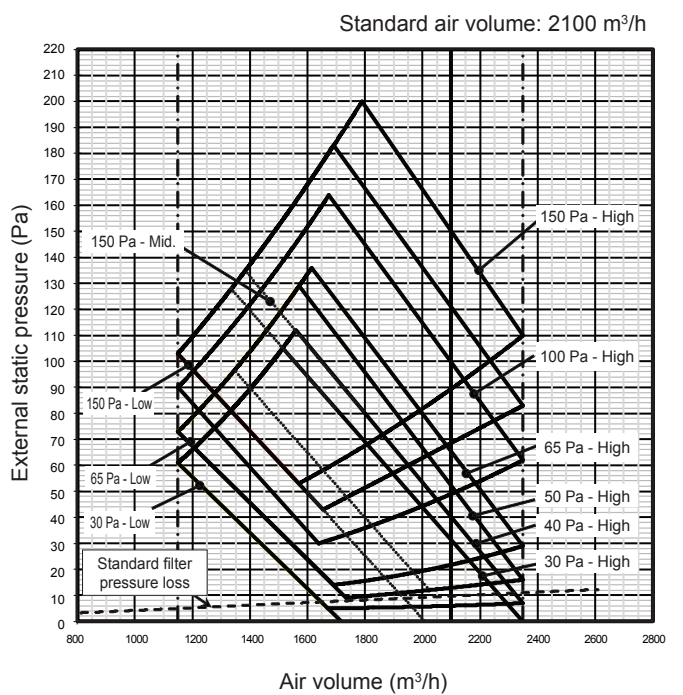

3. CONSTRUCTION VIEWS (EXTERNAL VIEWS)

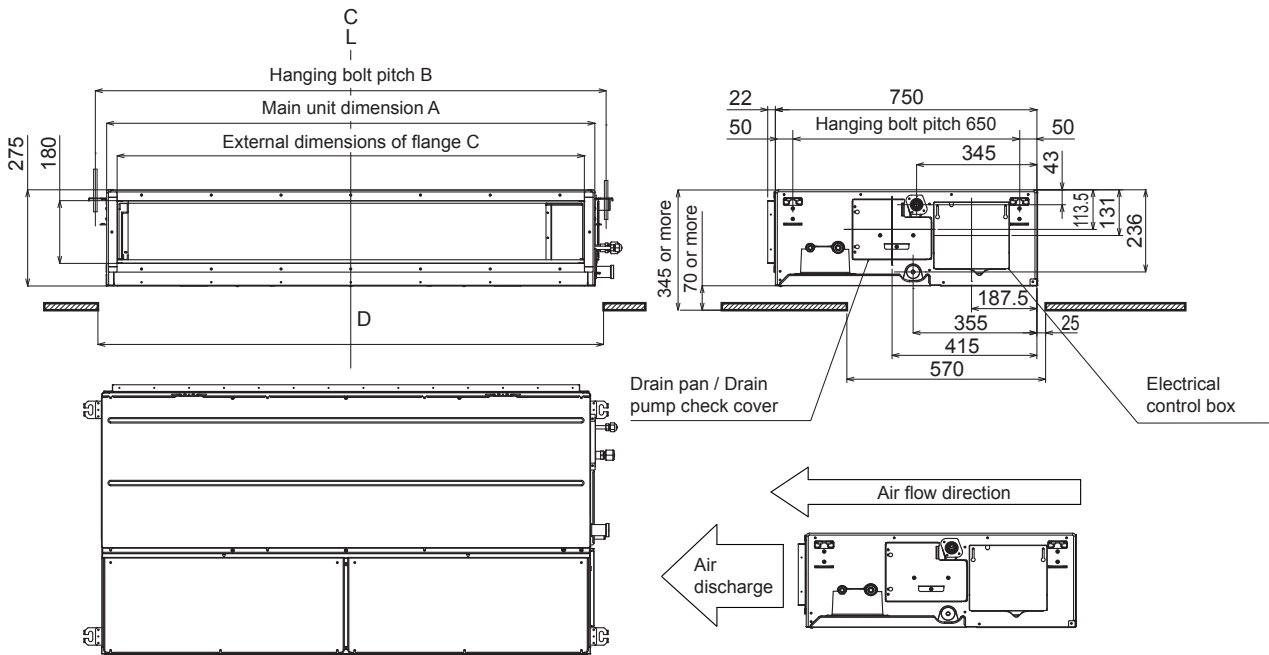

▼ Dimension

| Model | A | B | C | D |
|--------------------------------|------|------|------|------|
| HM56 type | 700 | 765 | 640 | 750 |
| HM80 type | 1000 | 1005 | 940 | 1050 |
| HM90, HM110, HM140, HM160 type | 1400 | 1465 | 1340 | 1450 |

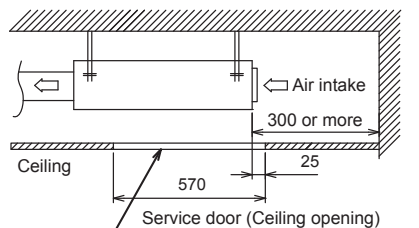
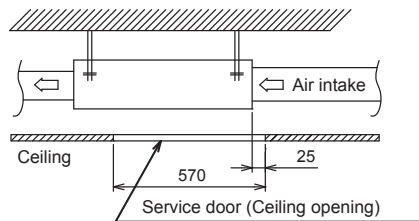
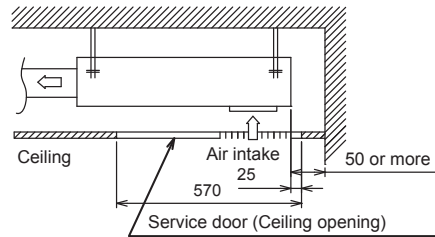
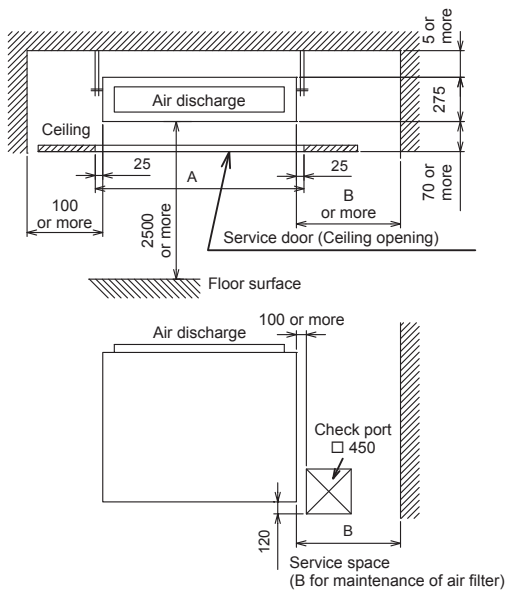

| Model | A | B |
|--------------------------------|------|-----|
| HM56 type | 750 | 700 |
| HM80 type | 1050 | 500 |
| HM90, HM110, HM140, HM160 type | 1450 | 700 |

HM56 type

<Under air intake>

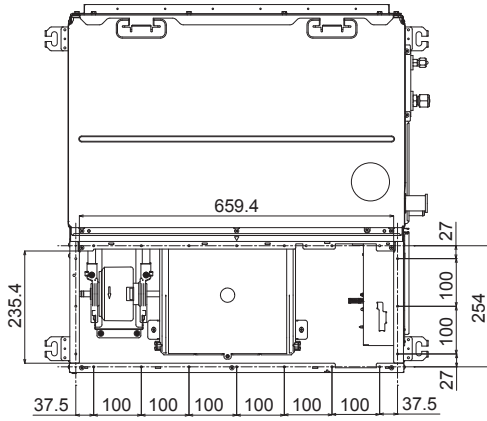

HM80 type

<Under air intake>

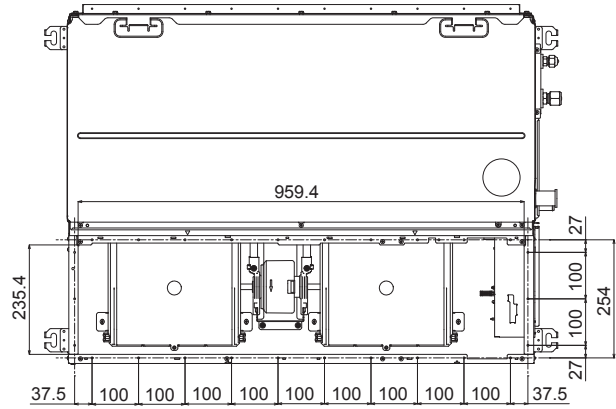

<Back air intake>

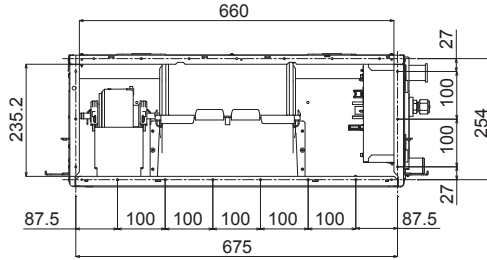

<Back air intake>

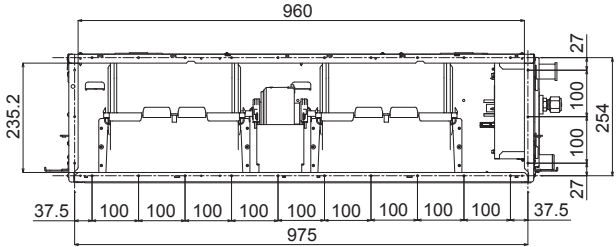

HM90, HM110, HM140, HM160 type

<Under air intake>

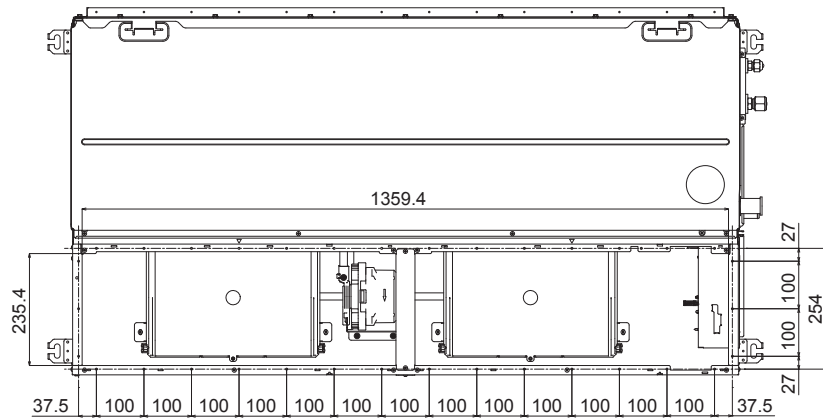

<Back air intake>

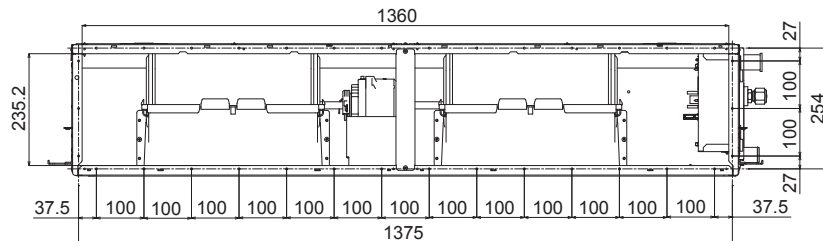

4. WIRING DIAGRAM

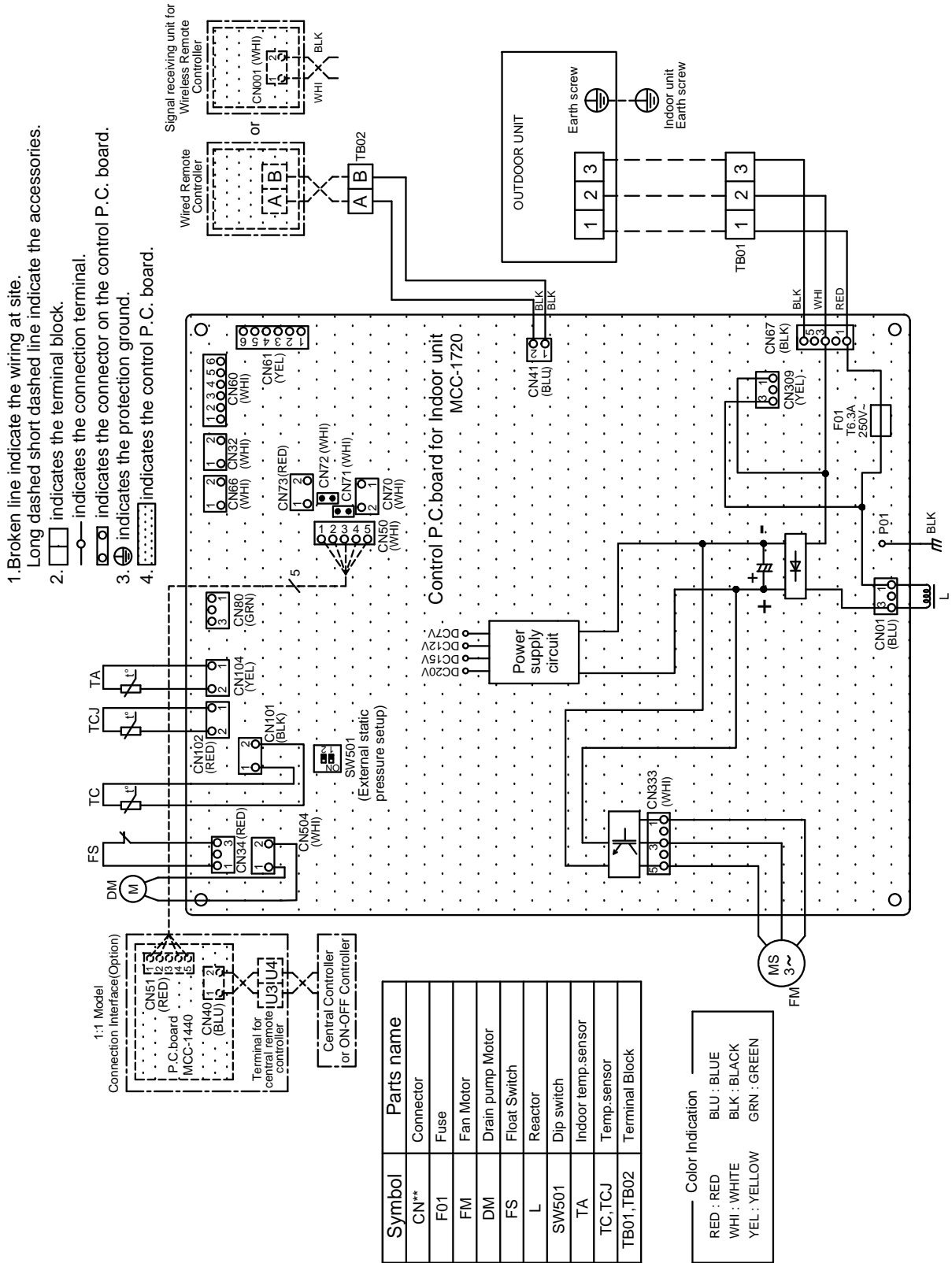

| Symbol | Parts name |
|------------|---------------------|
| CN** | Connector |
| F01 | Fuse |
| FM | Fan Motor |
| DM | Drain pump Motor |
| FS | Float Switch |
| L | Reactor |
| SW501 | Dip switch |
| TA | Indoor temp. sensor |
| TC, TCJ | Temp. sensor |
| TB01, TB02 | Terminal Block |

| Color Indication | |
|------------------|----------|
| RED | : RED |
| BLU | : BLUE |
| WHI | : WHITE |
| BLK | : BLACK |
| YEL | : YELLOW |
| GRN | : GREEN |

5. SPECIFICATIONS OF ELECTRICAL PARTS

Concealed Duct Type

| No. | Parts name | Type | Specifications |
|-----|---|---------------------------|-------------------------------|
| 1 | Fan motor (HM561) | ICF-340W150-2 | Output (Rated) 150W, 220-240V |
| 2 | Fan motor (HM801) | ICF-340W150-1 | Output (Rated) 150W, 220-240V |
| 3 | Fan motor (HM901, HM1101, HM1401, HM1601) | ICF-340W250-1 | Output (Rated) 250W, 220-240V |
| 4 | Thermo. Sensor (TA-sensor) | 218mm | 10k Ω at 25°C |
| 5 | Heat exchanger sensor (TCJ-sensor) | \varnothing 6mm, 1000mm | 10k Ω at 25°C |
| 6 | Heat exchanger sensor (TC-sensor) | \varnothing 6mm, 1000mm | 10k Ω at 25°C |
| 7 | Float switch | FS-1A-31-3 | |
| 8 | Drain pump motor | MDP-1401 | |
| 9 | Reactor | CH-49-Z-T | 14mH, 4A |

6. CONTROL BLOCK DIAGRAM

6-1. Indoor Controller Block Diagram

6-1-1. In Case of Connection of Wired (Simple) Remote Controller

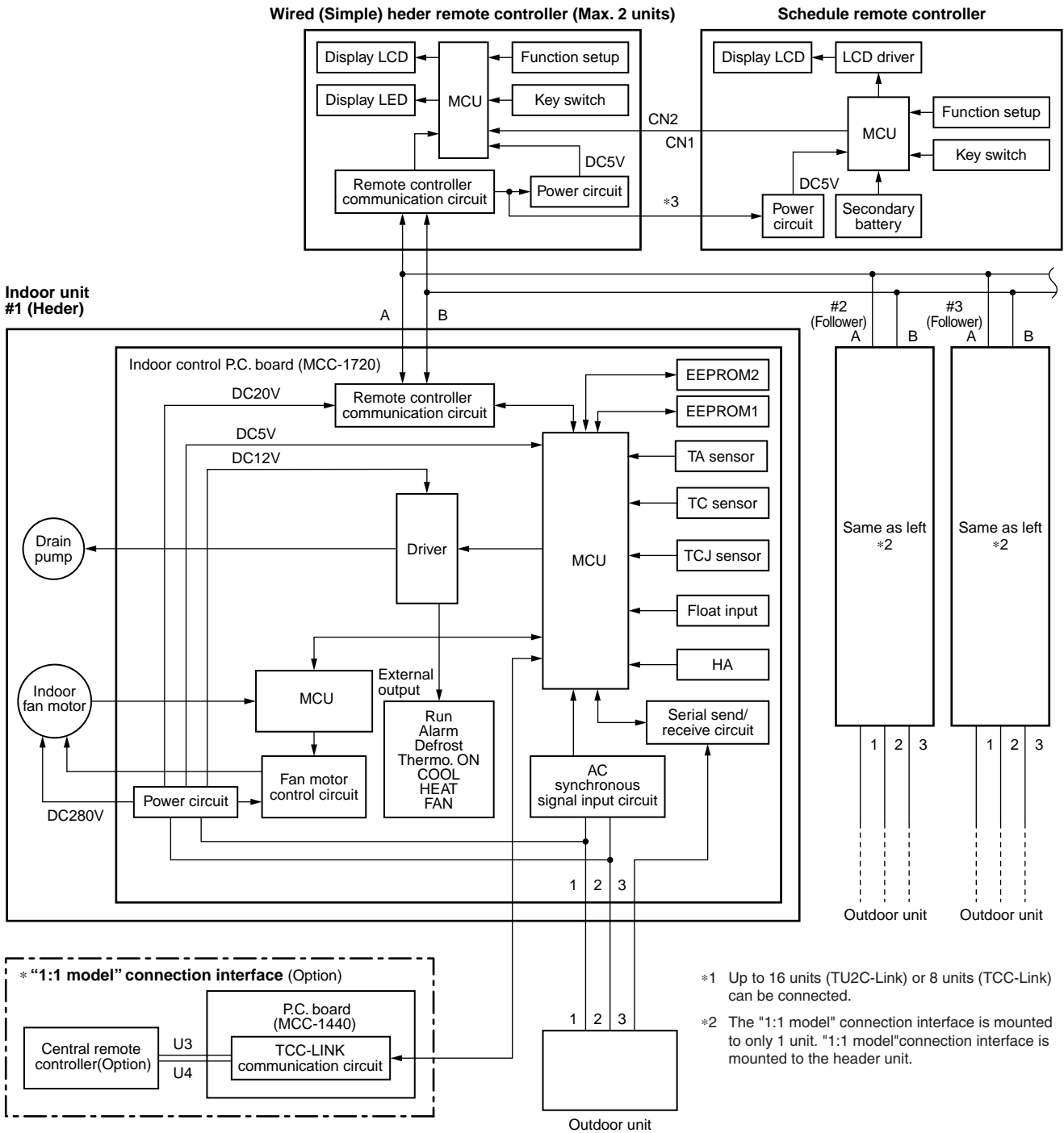

*1 Up to 16 units (TU2C-Link) or 8 units (TCC-Link) can be connected.
 *2 The "1:1 model" connection interface is mounted to only 1 unit. "1:1 model" connection interface is mounted to the header unit.

6-1-2. In Case of Connection of Wireless Remote Controller

**Indoor unit
#1 (Header)**

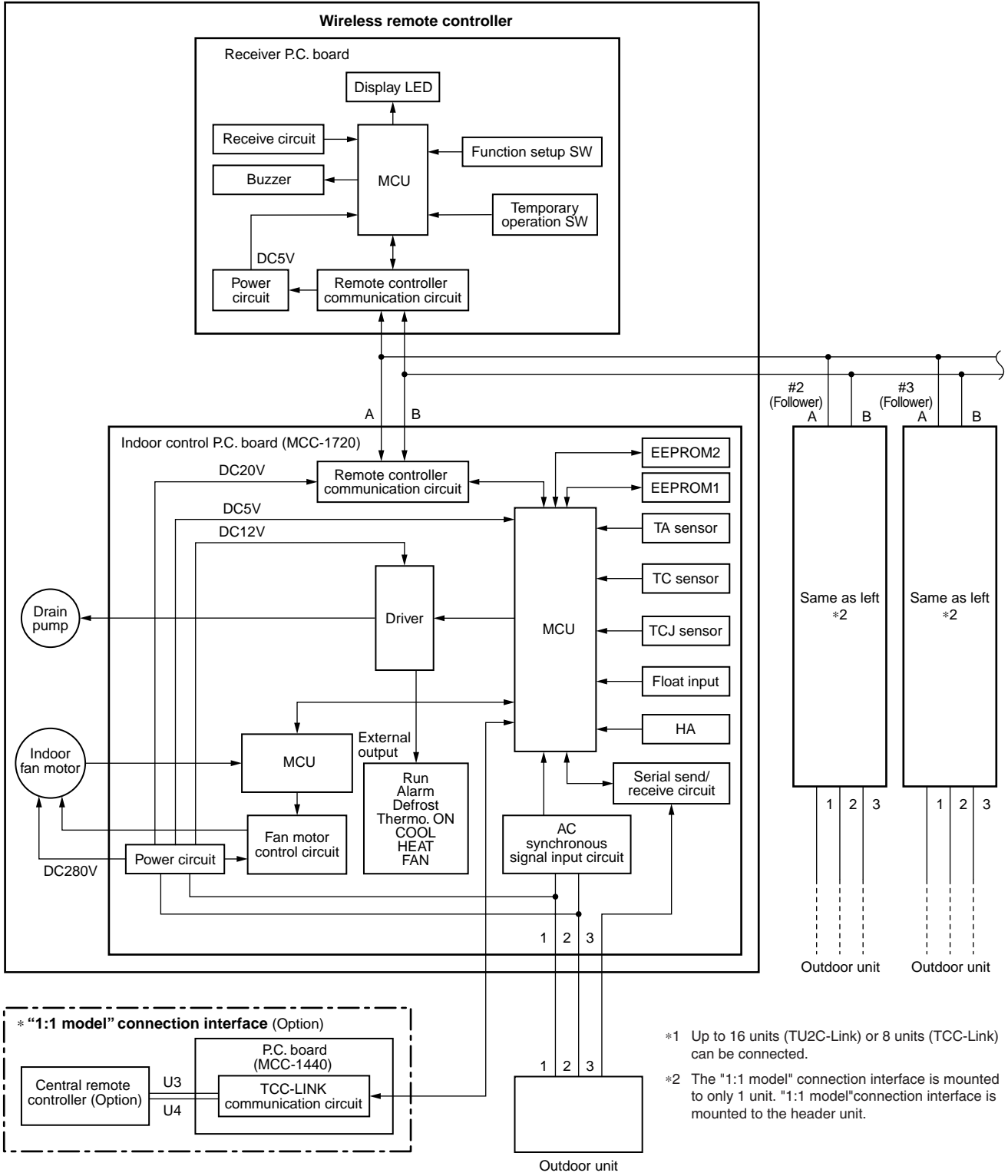

6-2. Control Specifications

| No. | Item | Outline of specifications | Remarks | | | | | | | | | | | | | | | | | | | | | | | | | | |
|--|--|---|-------------------------------|-----------------|------|----------------------------|------------|--|--------------|-------------------------|---------------|---------------|--------------|-------------------|------|--|---------------|-------------------------------|-------|----|----------------------------|-----|--|----|-------------------------|-----|----------|----|---|
| 1 | When power supply is reset | 1) Distinction of outdoor unit When the power supply is reset, the outdoors are distinguished and the control is selected according to the distinguished result. 2) Setting of indoor fan speed and existence of air direction adjustment Based on EEPROM data, select setting of the indoor fan speed. | Fan speed (rpm) | | | | | | | | | | | | | | | | | | | | | | | | | | |
| 2 | Operation mode selection | 1) Based on the operation mode selecting command from the remote controller, the operation mode is selected. <table border="1" style="margin: 10px 0;"> <thead> <tr> <th>Remote controller command</th> <th>Control outline</th> </tr> </thead> <tbody> <tr> <td>STOP</td> <td>Air conditioner stops.</td> </tr> <tr> <td>FAN</td> <td>Fan operation</td> </tr> <tr> <td>COOL</td> <td>Cooling operation</td> </tr> <tr> <td>DRY</td> <td>Dry operation</td> </tr> <tr> <td>HEAT</td> <td>Heating operation</td> </tr> <tr> <td>AUTO</td> <td> <ul style="list-style-type: none"> • COOL/HEAT operation mode is automatically selected by Ta, Ts and To for operation. • The operation is performed as shown in the following figure according to Ta value at the first time only. (In the range of $T_s + \alpha - 1 < T_a < T_s + \alpha + 1$, Cooling thermo. OFF (Fan)/Setup air volume operation continues.) <ul style="list-style-type: none"> • α is corrected according to the outside temperature. <table border="1" style="margin: 10px 0;"> <thead> <tr> <th>Outside temp.</th> <th>Correction value (α)</th> </tr> </thead> <tbody> <tr> <td>No To</td> <td>0K</td> </tr> <tr> <td>To $\geq 24^\circ\text{C}$</td> <td>-1K</td> </tr> <tr> <td>$24^\circ\text{C} > \text{To} \geq 18^\circ\text{C}$</td> <td>0K</td> </tr> <tr> <td>To $< 18^\circ\text{C}$</td> <td>+1K</td> </tr> <tr> <td>To error</td> <td>0K</td> </tr> </tbody> </table> </td> </tr> </tbody> </table> | Remote controller command | Control outline | STOP | Air conditioner stops. | FAN | Fan operation | COOL | Cooling operation | DRY | Dry operation | HEAT | Heating operation | AUTO | <ul style="list-style-type: none"> • COOL/HEAT operation mode is automatically selected by Ta, Ts and To for operation. • The operation is performed as shown in the following figure according to Ta value at the first time only. (In the range of $T_s + \alpha - 1 < T_a < T_s + \alpha + 1$, Cooling thermo. OFF (Fan)/Setup air volume operation continues.) <ul style="list-style-type: none"> • α is corrected according to the outside temperature. <table border="1" style="margin: 10px 0;"> <thead> <tr> <th>Outside temp.</th> <th>Correction value (α)</th> </tr> </thead> <tbody> <tr> <td>No To</td> <td>0K</td> </tr> <tr> <td>To $\geq 24^\circ\text{C}$</td> <td>-1K</td> </tr> <tr> <td>$24^\circ\text{C} > \text{To} \geq 18^\circ\text{C}$</td> <td>0K</td> </tr> <tr> <td>To $< 18^\circ\text{C}$</td> <td>+1K</td> </tr> <tr> <td>To error</td> <td>0K</td> </tr> </tbody> </table> | Outside temp. | Correction value (α) | No To | 0K | To $\geq 24^\circ\text{C}$ | -1K | $24^\circ\text{C} > \text{To} \geq 18^\circ\text{C}$ | 0K | To $< 18^\circ\text{C}$ | +1K | To error | 0K | Ta: Room temp. Ts: Setup temp. To: Outside temp. K = deg |
| Remote controller command | Control outline | | | | | | | | | | | | | | | | | | | | | | | | | | | | |
| STOP | Air conditioner stops. | | | | | | | | | | | | | | | | | | | | | | | | | | | | |
| FAN | Fan operation | | | | | | | | | | | | | | | | | | | | | | | | | | | | |
| COOL | Cooling operation | | | | | | | | | | | | | | | | | | | | | | | | | | | | |
| DRY | Dry operation | | | | | | | | | | | | | | | | | | | | | | | | | | | | |
| HEAT | Heating operation | | | | | | | | | | | | | | | | | | | | | | | | | | | | |
| AUTO | <ul style="list-style-type: none"> • COOL/HEAT operation mode is automatically selected by Ta, Ts and To for operation. • The operation is performed as shown in the following figure according to Ta value at the first time only. (In the range of $T_s + \alpha - 1 < T_a < T_s + \alpha + 1$, Cooling thermo. OFF (Fan)/Setup air volume operation continues.) <ul style="list-style-type: none"> • α is corrected according to the outside temperature. <table border="1" style="margin: 10px 0;"> <thead> <tr> <th>Outside temp.</th> <th>Correction value (α)</th> </tr> </thead> <tbody> <tr> <td>No To</td> <td>0K</td> </tr> <tr> <td>To $\geq 24^\circ\text{C}$</td> <td>-1K</td> </tr> <tr> <td>$24^\circ\text{C} > \text{To} \geq 18^\circ\text{C}$</td> <td>0K</td> </tr> <tr> <td>To $< 18^\circ\text{C}$</td> <td>+1K</td> </tr> <tr> <td>To error</td> <td>0K</td> </tr> </tbody> </table> | Outside temp. | Correction value (α) | No To | 0K | To $\geq 24^\circ\text{C}$ | -1K | $24^\circ\text{C} > \text{To} \geq 18^\circ\text{C}$ | 0K | To $< 18^\circ\text{C}$ | +1K | To error | 0K | | | | | | | | | | | | | | | | |
| Outside temp. | Correction value (α) | | | | | | | | | | | | | | | | | | | | | | | | | | | | |
| No To | 0K | | | | | | | | | | | | | | | | | | | | | | | | | | | | |
| To $\geq 24^\circ\text{C}$ | -1K | | | | | | | | | | | | | | | | | | | | | | | | | | | | |
| $24^\circ\text{C} > \text{To} \geq 18^\circ\text{C}$ | 0K | | | | | | | | | | | | | | | | | | | | | | | | | | | | |
| To $< 18^\circ\text{C}$ | +1K | | | | | | | | | | | | | | | | | | | | | | | | | | | | |
| To error | 0K | | | | | | | | | | | | | | | | | | | | | | | | | | | | |
| 3 | Room temp. control | 1) Adjustment range: Remote controller setup temperature (°C) <table border="1" style="margin: 10px 0;"> <thead> <tr> <th></th> <th>COOL/DRY</th> <th>HEAT</th> <th>AUTO</th> </tr> </thead> <tbody> <tr> <td>Wired type</td> <td>18°C to 29°C</td> <td>18°C to 29°C</td> <td>18°C to 29°C</td> </tr> <tr> <td>Wireless type</td> <td>17°C to 30°C</td> <td>17°C to 30°C</td> <td>17°C to 30°C</td> </tr> </tbody> </table> | | COOL/DRY | HEAT | AUTO | Wired type | 18°C to 29°C | 18°C to 29°C | 18°C to 29°C | Wireless type | 17°C to 30°C | 17°C to 30°C | 17°C to 30°C | | | | | | | | | | | | | | | |
| | COOL/DRY | HEAT | AUTO | | | | | | | | | | | | | | | | | | | | | | | | | | |
| Wired type | 18°C to 29°C | 18°C to 29°C | 18°C to 29°C | | | | | | | | | | | | | | | | | | | | | | | | | | |
| Wireless type | 17°C to 30°C | 17°C to 30°C | 17°C to 30°C | | | | | | | | | | | | | | | | | | | | | | | | | | |

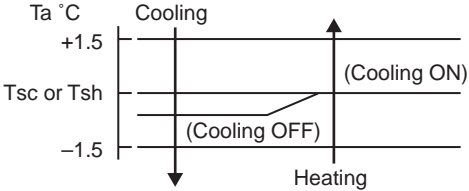
| No. | Item | Outline of specifications | Remarks | | | | | | | | | | | | |
|------------------------|--|--|---|------|---|---|---|------------------------|------|------|------|------|----------|---|---|
| 3 | Room temp. control (Continued) | 2) Using the CODE No. 06, the setup temperature in heating operation can be corrected. <table border="1" data-bbox="443 286 1096 394"> <thead> <tr> <th>SET DATA</th> <th>0</th> <th>2</th> <th>4</th> <th>6</th> </tr> </thead> <tbody> <tr> <td>Setup temp. correction</td> <td>+0°C</td> <td>+2°C</td> <td>+4°C</td> <td>+6°C</td> </tr> </tbody> </table> Setting at shipment <table border="1" data-bbox="443 450 754 490"> <tbody> <tr> <td>SET DATA</td> <td>2</td> </tr> </tbody> </table> | SET DATA | 0 | 2 | 4 | 6 | Setup temp. correction | +0°C | +2°C | +4°C | +6°C | SET DATA | 2 | Shift of suction temperature in heating operation |
| SET DATA | 0 | 2 | 4 | 6 | | | | | | | | | | | |
| Setup temp. correction | +0°C | +2°C | +4°C | +6°C | | | | | | | | | | | |
| SET DATA | 2 | | | | | | | | | | | | | | |
| 4 | Automatic capacity control (GA control) | 1) Based on the difference between Ta and Ts, the operation frequency is instructed to the outdoor unit. 2) Cooling operation Every 90 seconds, the room temperature difference between temperature detected by Ta and Ts and the varied room temperature value are calculated to obtain the correction value of the frequency command and then the present frequency command is corrected. $Ta(n) - Ts(n)$: Room temp. difference n : Counts of detection $Ta(n-1) - Ts(n)$: Varied room temp. value $n - 1$: Counts of detection of 90 seconds before 3) Heating operation Every 1 minute (60 sec.), the room temperature difference between temperature detected by Ta and Ts and the varied room temperature value are calculated to obtain the correction value of the frequency command and then the present frequency command is corrected. $Ts(n) - Ta(n)$: Room temp. difference n : Counts of detection $Ta(n) - Ta(n - 1)$: Varied room temp. value $n - 1$: Counts of detection of 1 minute before 4) Dry operation The frequency correction control is same as those of the cooling operation. However the maximum frequency is limited to approximately "S6". Note) When LOW is set up, the maximum frequency is limited to approximately "SB". | | | | | | | | | | | | | |
| 5 | Automatic cooling/heating control | 1) The judgment of selecting COOL/HEAT is carried out as shown below. When +1.5°C exceeds against Tsh 10 minutes and after thermo. OFF, heating operation (Thermo. OFF) exchanges to cooling operation. Description in the parentheses shows an example of cooling ON/OFF. <div style="text-align: center;">  </div> When -1.5°C lowers against Tsc 10 minutes and after thermo. OFF, cooling operation (Thermo. OFF) exchanges to heating operation. 2) For the automatic capacity control after judgment of cooling/heating, see Item 4. 3) For temperature correction of room temp. control in automatic heating, see Item 3. | Tsc: Setup temp. in cooling operation Tsh: Setup temp. in heating operation + temp. correction of room temp. control | | | | | | | | | | | | |

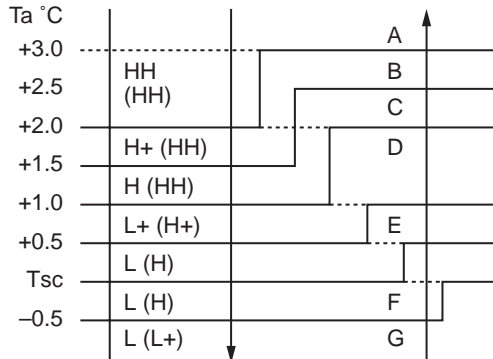
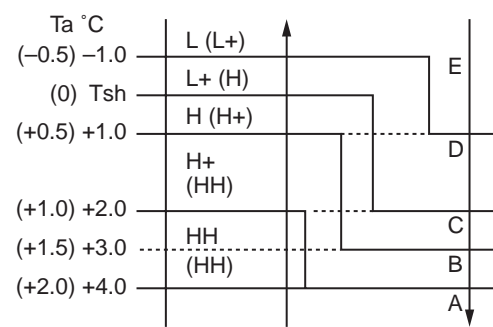
| No. | Item | Outline of specifications | Remarks |
|-----|-------------------|---|---|
| 6 | Fan speed control | <p>1) Operation with (HH), (H), (L) or [AUTO] mode is carried out by the command from the remote controller.</p> <p>2) When the fan speed mode [AUTO] is selected, the fan speed varies by the difference between T_a and T_s.</p> <p><COOL></p>  <ul style="list-style-type: none"> Controlling operation in case when thermostat of remote controller works is same as a case when thermostat of the body works. If the fan speed has been changed once, it is not changed for 3 minutes. However when the air volume is exchanged, the fan speed changes. When cooling operation has started, select a downward slope for the fan speed, that is, the high position. If the temperature is just on the difference boundary, the fan speed does not change. Mode in the parentheses indicates one in automatic cooling operation. <p><HEAT></p>  <p>Value in the parentheses indicates one when thermostat of the remote controller works. Value without parentheses indicates one when thermostat of the body works.</p> <ul style="list-style-type: none"> If the fan speed has been changed once, it is not changed for 1 minute. However when the fan speed exchanged, the fan speed changes. When heating operation has started, select an upward slope for the fan speed, that is, the high position. If the temperature is just on the difference boundary, the fan speed does not change. Mode in the parentheses indicates one in automatic heating operation. In $T_c \geq 60^\circ\text{C}$, the fan speed increases by 1 step. | <p>HH > H+ > H > L+ > L > UL</p> <p>Tc: Indoor heat exchanger sensor temperature</p> |

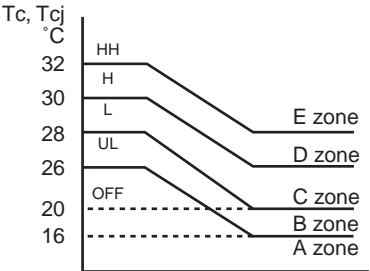

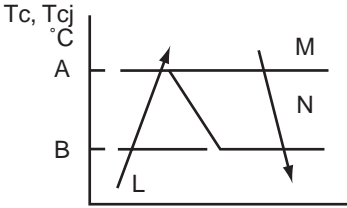

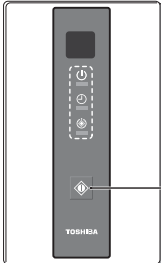

| No. | Item | Outline of specifications | Remarks | | | | | | | | | | | | | | | | | | | | | | | | | | | | | | | | | | | | | | | | | | | | | | | | | | | | | | | | | | | | | | | | | | | | | | | | | | | | | | | | | | | | | | | | | | | | | | | | | | | | | | | | | | | | | | | | | | | | | | |
|------------------|---------------------------------------|---|--|----------|--------|--------|--|--------|--|------|--|------|--|------|--|---------------|---------|--|--------|--|--------|--|-----|------|------|------|------|------|------|----|--|--|--|--|----|----|----|--|--|----|----|--|--|----|--|--|--|----|-------|-------|----|--|--|----|--|--|--|----|--|----|--|---|--|--|----|----|--|---|--|----|----|----|----|----|--|--|---|---|----|--|---|--|----|--|--|----|---|--|----|---|--|--|----|--|----|---|--|--|--|----|----|---|--|--|--|--|----|---|--|--|--|--|--|----|----|----|----|----|----|----|---|
| 6 | Fan speed control (Continued) | <table border="1" data-bbox="464 215 1150 752"> <thead> <tr> <th rowspan="2">CODE No. [5d]</th> <th colspan="2">Standard</th> <th colspan="2">Type 1</th> <th colspan="2">Type 3</th> </tr> <tr> <th colspan="2">0000</th> <th colspan="2">0001</th> <th colspan="2">0003</th> </tr> <tr> <th>SW501 (1)/(2)</th> <th colspan="2">OFF/OFF</th> <th colspan="2">ON/OFF</th> <th colspan="2">OFF/ON</th> </tr> <tr> <th>Tap</th> <th>COOL</th> <th>HEAT</th> <th>COOL</th> <th>HEAT</th> <th>COOL</th> <th>HEAT</th> </tr> </thead> <tbody> <tr><td>F1</td><td></td><td></td><td></td><td></td><td>HH</td><td>HH</td></tr> <tr><td>F2</td><td></td><td></td><td>HH</td><td>HH</td><td></td><td></td></tr> <tr><td>F3</td><td></td><td></td><td></td><td>H+</td><td>H+, H</td><td>H+, H</td></tr> <tr><td>F4</td><td></td><td></td><td>H+</td><td></td><td></td><td></td></tr> <tr><td>F5</td><td></td><td>HH</td><td></td><td>H</td><td></td><td></td></tr> <tr><td>F6</td><td>HH</td><td></td><td>H</td><td></td><td>L+</td><td>L+</td></tr> <tr><td>F7</td><td>H+</td><td>H+</td><td></td><td></td><td>L</td><td>L</td></tr> <tr><td>F8</td><td></td><td>H</td><td></td><td>L+</td><td></td><td></td></tr> <tr><td>F9</td><td>H</td><td></td><td>L+</td><td>L</td><td></td><td></td></tr> <tr><td>FA</td><td></td><td>L+</td><td>L</td><td></td><td></td><td></td></tr> <tr><td>FB</td><td>L+</td><td>L</td><td></td><td></td><td></td><td></td></tr> <tr><td>FC</td><td>L</td><td></td><td></td><td></td><td></td><td></td></tr> <tr><td>FD</td><td>UL</td><td>UL</td><td>UL</td><td>UL</td><td>UL</td><td>UL</td></tr> </tbody> </table> <p data-bbox="459 786 1190 1178"> 3) In heating operation, the mode changes to [UL] if thermostat is turned off. 4) If $T_a \geq 25^\circ\text{C}$ when heating operation has started and when defrost operation has been cleared, the air conditioner operates with (H) mode or higher mode for 1 minute after T_c entered in E zone of cool air discharge preventive control (No. 7). 5) Self-clean operation When performing self-clean operation after stopping the cooling operation, the mode becomes 310 rpm. ✕ When the factory is shipped, self-clean operation is not set. </p> | CODE No. [5d] | Standard | | Type 1 | | Type 3 | | 0000 | | 0001 | | 0003 | | SW501 (1)/(2) | OFF/OFF | | ON/OFF | | OFF/ON | | Tap | COOL | HEAT | COOL | HEAT | COOL | HEAT | F1 | | | | | HH | HH | F2 | | | HH | HH | | | F3 | | | | H+ | H+, H | H+, H | F4 | | | H+ | | | | F5 | | HH | | H | | | F6 | HH | | H | | L+ | L+ | F7 | H+ | H+ | | | L | L | F8 | | H | | L+ | | | F9 | H | | L+ | L | | | FA | | L+ | L | | | | FB | L+ | L | | | | | FC | L | | | | | | FD | UL | UL | UL | UL | UL | UL | <p data-bbox="1219 1010 1414 1070">[Self-clean ☺] is displayed.</p> |
| CODE No. [5d] | Standard | | | Type 1 | | Type 3 | | | | | | | | | | | | | | | | | | | | | | | | | | | | | | | | | | | | | | | | | | | | | | | | | | | | | | | | | | | | | | | | | | | | | | | | | | | | | | | | | | | | | | | | | | | | | | | | | | | | | | | | | | | | | | | | | | | |
| | 0000 | | 0001 | | 0003 | | | | | | | | | | | | | | | | | | | | | | | | | | | | | | | | | | | | | | | | | | | | | | | | | | | | | | | | | | | | | | | | | | | | | | | | | | | | | | | | | | | | | | | | | | | | | | | | | | | | | | | | | | | | | | | | | | | | |
| SW501 (1)/(2) | OFF/OFF | | ON/OFF | | OFF/ON | | | | | | | | | | | | | | | | | | | | | | | | | | | | | | | | | | | | | | | | | | | | | | | | | | | | | | | | | | | | | | | | | | | | | | | | | | | | | | | | | | | | | | | | | | | | | | | | | | | | | | | | | | | | | | | | | | | | |
| Tap | COOL | HEAT | COOL | HEAT | COOL | HEAT | | | | | | | | | | | | | | | | | | | | | | | | | | | | | | | | | | | | | | | | | | | | | | | | | | | | | | | | | | | | | | | | | | | | | | | | | | | | | | | | | | | | | | | | | | | | | | | | | | | | | | | | | | | | | | | | | | | |
| F1 | | | | | HH | HH | | | | | | | | | | | | | | | | | | | | | | | | | | | | | | | | | | | | | | | | | | | | | | | | | | | | | | | | | | | | | | | | | | | | | | | | | | | | | | | | | | | | | | | | | | | | | | | | | | | | | | | | | | | | | | | | | | | |
| F2 | | | HH | HH | | | | | | | | | | | | | | | | | | | | | | | | | | | | | | | | | | | | | | | | | | | | | | | | | | | | | | | | | | | | | | | | | | | | | | | | | | | | | | | | | | | | | | | | | | | | | | | | | | | | | | | | | | | | | | | | | | | | | |
| F3 | | | | H+ | H+, H | H+, H | | | | | | | | | | | | | | | | | | | | | | | | | | | | | | | | | | | | | | | | | | | | | | | | | | | | | | | | | | | | | | | | | | | | | | | | | | | | | | | | | | | | | | | | | | | | | | | | | | | | | | | | | | | | | | | | | | | |
| F4 | | | H+ | | | | | | | | | | | | | | | | | | | | | | | | | | | | | | | | | | | | | | | | | | | | | | | | | | | | | | | | | | | | | | | | | | | | | | | | | | | | | | | | | | | | | | | | | | | | | | | | | | | | | | | | | | | | | | | | | | | | | | |
| F5 | | HH | | H | | | | | | | | | | | | | | | | | | | | | | | | | | | | | | | | | | | | | | | | | | | | | | | | | | | | | | | | | | | | | | | | | | | | | | | | | | | | | | | | | | | | | | | | | | | | | | | | | | | | | | | | | | | | | | | | | | | | | |
| F6 | HH | | H | | L+ | L+ | | | | | | | | | | | | | | | | | | | | | | | | | | | | | | | | | | | | | | | | | | | | | | | | | | | | | | | | | | | | | | | | | | | | | | | | | | | | | | | | | | | | | | | | | | | | | | | | | | | | | | | | | | | | | | | | | | | |
| F7 | H+ | H+ | | | L | L | | | | | | | | | | | | | | | | | | | | | | | | | | | | | | | | | | | | | | | | | | | | | | | | | | | | | | | | | | | | | | | | | | | | | | | | | | | | | | | | | | | | | | | | | | | | | | | | | | | | | | | | | | | | | | | | | | | |
| F8 | | H | | L+ | | | | | | | | | | | | | | | | | | | | | | | | | | | | | | | | | | | | | | | | | | | | | | | | | | | | | | | | | | | | | | | | | | | | | | | | | | | | | | | | | | | | | | | | | | | | | | | | | | | | | | | | | | | | | | | | | | | | | |
| F9 | H | | L+ | L | | | | | | | | | | | | | | | | | | | | | | | | | | | | | | | | | | | | | | | | | | | | | | | | | | | | | | | | | | | | | | | | | | | | | | | | | | | | | | | | | | | | | | | | | | | | | | | | | | | | | | | | | | | | | | | | | | | | | |
| FA | | L+ | L | | | | | | | | | | | | | | | | | | | | | | | | | | | | | | | | | | | | | | | | | | | | | | | | | | | | | | | | | | | | | | | | | | | | | | | | | | | | | | | | | | | | | | | | | | | | | | | | | | | | | | | | | | | | | | | | | | | | | | |
| FB | L+ | L | | | | | | | | | | | | | | | | | | | | | | | | | | | | | | | | | | | | | | | | | | | | | | | | | | | | | | | | | | | | | | | | | | | | | | | | | | | | | | | | | | | | | | | | | | | | | | | | | | | | | | | | | | | | | | | | | | | | | | | |
| FC | L | | | | | | | | | | | | | | | | | | | | | | | | | | | | | | | | | | | | | | | | | | | | | | | | | | | | | | | | | | | | | | | | | | | | | | | | | | | | | | | | | | | | | | | | | | | | | | | | | | | | | | | | | | | | | | | | | | | | | | | | |
| FD | UL | UL | UL | UL | UL | UL | | | | | | | | | | | | | | | | | | | | | | | | | | | | | | | | | | | | | | | | | | | | | | | | | | | | | | | | | | | | | | | | | | | | | | | | | | | | | | | | | | | | | | | | | | | | | | | | | | | | | | | | | | | | | | | | | | | |
| 7 | Cool air discharge preventive control | <p data-bbox="459 1227 1190 1447"> 1) In heating operation, the indoor fan is controlled based on the detected temperature of T_c sensor or T_{cj} sensor. As shown below, the upper limit of the revolution frequency is restricted. However B zone is assumed as C zone for 6 minutes and after when the compressor activated. In defrost operation, the control value of T_c is shifted by 6°C. </p>  | <p data-bbox="1219 1227 1437 1525"> In D and E zones, the priority is given to air volume selection setup of remote controller. In A zone while thermo is ON, [PRE-HEAT ☼ (Heating ready)] is displayed. </p> | | | | | | | | | | | | | | | | | | | | | | | | | | | | | | | | | | | | | | | | | | | | | | | | | | | | | | | | | | | | | | | | | | | | | | | | | | | | | | | | | | | | | | | | | | | | | | | | | | | | | | | | | | | | | | | | | | | | | | |





| No. | Item | Outline of specifications | Remarks | | | | | | |
|------------------|----------------------------|---|------------------|--|---|---|---------|---------|---|
| 9 | High-temp. release control | <p>1) The heating operation is performed as follows based on the detected temperature of Tc sensor or Tcj sensor.</p> <ul style="list-style-type: none"> • When [M] zone is detected, the commanded frequency is decreased from the real operation frequency. After then the commanded frequency changes every 30 seconds while operation is performed in [M] zone. • In [N] zone, the commanded frequency is held. • When [L] zone is detected, the commanded frequency is returned to the original value by approx. 6Hz every 60 seconds. <p>Setup at shipment</p> <table border="1" data-bbox="435 600 678 719"> <thead> <tr> <th colspan="2">Control temp. °C</th> </tr> <tr> <th>A</th> <th>B</th> </tr> </thead> <tbody> <tr> <td>56 (54)</td> <td>52 (52)</td> </tr> </tbody> </table>  <p>NOTE: When the operation has started or when Tc or Tcj < 30°C at start of the operation or after operation start, temperature is controlled between values in parentheses of A and B.</p> | Control temp. °C | | A | B | 56 (54) | 52 (52) | <p>However this control is ignored in case of the follower unit of the twin.</p> <p>Same status as that when “thermostat-OFF” (status that the air conditioner enters in the room temp. monitor mode when the temperature reached the setup temperature on the remote controller)</p> |
| Control temp. °C | | | | | | | | | |
| A | B | | | | | | | | |
| 56 (54) | 52 (52) | | | | | | | | |
| 10 | Drain pump control | <ol style="list-style-type: none"> 1) In cooling operation (including Dry operation), the drain pump is usually operated. 2) If the float switch works while drain pump drives, the compressor stops, the drain pump continues the operation, and a check code is output. 3) If the float switch works while drain pump stops, the compressor stops and the drain pump operates. If the float switch keeps operating for approx. 4 minutes, a check code is output. | Check code [P10] | | | | | | |
| 11 | After-heat elimination | When heating operation stops, in some cases, the indoor fan operates with (L) for approx. 30 seconds. | | | | | | | |

| No. | Item | Outline of specifications | Remarks |
|-----|--------------------------------------|--|---|
| 12 | Frequency fixed operation (Test run) | <p><In case of wired remote controller></p> <ol style="list-style-type: none"> 1) When pushing [CHK] button for 4 seconds or more, [TEST] is displayed on the display screen and the mode enters in Test run mode. 2) Push [ON/OFF] button. 3) Using [MODE] button, set the mode to [COOL] or [HEAT]. <ul style="list-style-type: none"> • Do not use other mode than [COOL]/[HEAT] mode. • During test run operation, the temperature cannot be adjusted. • An error is detected as usual. • A frequency fixed operation is performed. 4) After the test run, push [ON/OFF] button to stop the operation. (Display in the display part is same as the procedure in Item 1.) 5) Push [CHK] button to clear the test run mode. ([TEST] display in the display part disappears and the status returns to the normal stop status.) <p><In case of wireless remote controller></p> <ol style="list-style-type: none"> 1) When TEMPORARY button is pushed for 10 seconds or more, "Pi!" sound is heard and the operation changes to test run. After approx. 3 minutes, a cooling operation starts forcibly. Check cool air starts blowing. If the operation does not start, check wiring again. 2) To stop a test operation, push TEMPORARY button once again (Approx. 1 second). Check wiring / piping of the indoor and outdoor units in test run. <div style="text-align: center;">  <p>TEMPORARY button</p> </div> | Command frequency is approximately [S7] |

| No. | Item | Outline of specifications | Remarks | | | | | | | | | | | | | | | | | | | | | | | | | | | | | | | | | | | | | | | | | | | | | | | | | | | | | | | | | | | | | | | | | | | | | | | | | | | | | | | | |
|------------------------|--------------------------------|---|---------|-------|------|-------|-------|------|------|------|------------------------|------|------|------|-------|------|-------|-------|----|------|------|------|------|------|------|------|----|------|------|------|------|------|------|------|------------------------|------|------|------|-------|------|-------|-------|----|------|------|------|------|------|------|------|-----|------|------|------|------|------|------|------|------------------------|------|------|------|-------|------|-------|-------|-----|------|------|------|------|------|------|------|-----|------|------|------|------|------|------|------|--|
| 13 | Filter sign display | <p>Operation time</p> <ol style="list-style-type: none"> 1) The operation time of the indoor fan is calculated, the filter reset signal is sent to the remote controller when the specified time (2500H) has passed, and it is displayed on LCD. 2) When the filter reset signal has been received from the remote controller, time of the calculation timer is cleared. In this case, the measurement time is reset if the specified time has passed, and display on LCD disappears. <p>Filter clog detection (Duct model)</p> <ol style="list-style-type: none"> 1) When the fan speed (Fan only mode HH tap) exceed specified value for 5 min, the filter reset signal is sent to the remote controller, and it is displayed on LCD. 2) When the filter reset signal has been received from the remote controller, filter sign is cleared and display on LCD disappears. In this case, the measurement time is also reset. <p>* Factory setting is unavailable (DN [22B] = 0000). When specified value is input to the DN [22B], this function is available.</p> <p>* Specified value are determined each static pressure setting, so when DN [5D] is changed, DN [22B] is also changed to shipment setting (0000).</p> <p>DN[22B]</p> <table border="1" data-bbox="505 1097 1334 1608"> <thead> <tr> <th>DN [5D]</th> <th>0000</th> <th>0001</th> <th>0002</th> <th>0003</th> <th>0004</th> <th>0005</th> <th>0006</th> </tr> </thead> <tbody> <tr> <td>Static pressure</td> <td>30Pa</td> <td>50Pa</td> <td>40Pa</td> <td>100Pa</td> <td>65Pa</td> <td>120Pa</td> <td>150Pa</td> </tr> <tr> <td>56</td> <td>0082</td> <td>0091</td> <td>0086</td> <td>0106</td> <td>0097</td> <td>0109</td> <td>0115</td> </tr> <tr> <td>80</td> <td>0081</td> <td>0092</td> <td>0085</td> <td>0103</td> <td>0097</td> <td>0107</td> <td>0112</td> </tr> <tr> <td>Static pressure</td> <td>40Pa</td> <td>30Pa</td> <td>50Pa</td> <td>100Pa</td> <td>65Pa</td> <td>120Pa</td> <td>150Pa</td> </tr> <tr> <td>90</td> <td>0083</td> <td>0082</td> <td>0088</td> <td>0098</td> <td>0092</td> <td>0100</td> <td>0108</td> </tr> <tr> <td>110</td> <td>0095</td> <td>0091</td> <td>0093</td> <td>0102</td> <td>0097</td> <td>0106</td> <td>0112</td> </tr> <tr> <td>Static pressure</td> <td>50Pa</td> <td>30Pa</td> <td>40Pa</td> <td>100Pa</td> <td>65Pa</td> <td>120Pa</td> <td>150Pa</td> </tr> <tr> <td>140</td> <td>0095</td> <td>0091</td> <td>0093</td> <td>0102</td> <td>0097</td> <td>0106</td> <td>0112</td> </tr> <tr> <td>160</td> <td>0095</td> <td>0091</td> <td>0093</td> <td>0102</td> <td>0097</td> <td>0106</td> <td>0112</td> </tr> </tbody> </table> | DN [5D] | 0000 | 0001 | 0002 | 0003 | 0004 | 0005 | 0006 | Static pressure | 30Pa | 50Pa | 40Pa | 100Pa | 65Pa | 120Pa | 150Pa | 56 | 0082 | 0091 | 0086 | 0106 | 0097 | 0109 | 0115 | 80 | 0081 | 0092 | 0085 | 0103 | 0097 | 0107 | 0112 | Static pressure | 40Pa | 30Pa | 50Pa | 100Pa | 65Pa | 120Pa | 150Pa | 90 | 0083 | 0082 | 0088 | 0098 | 0092 | 0100 | 0108 | 110 | 0095 | 0091 | 0093 | 0102 | 0097 | 0106 | 0112 | Static pressure | 50Pa | 30Pa | 40Pa | 100Pa | 65Pa | 120Pa | 150Pa | 140 | 0095 | 0091 | 0093 | 0102 | 0097 | 0106 | 0112 | 160 | 0095 | 0091 | 0093 | 0102 | 0097 | 0106 | 0112 | [FILTER ] goes on. |
| DN [5D] | 0000 | 0001 | 0002 | 0003 | 0004 | 0005 | 0006 | | | | | | | | | | | | | | | | | | | | | | | | | | | | | | | | | | | | | | | | | | | | | | | | | | | | | | | | | | | | | | | | | | | | | | | | | | | | |
| Static pressure | 30Pa | 50Pa | 40Pa | 100Pa | 65Pa | 120Pa | 150Pa | | | | | | | | | | | | | | | | | | | | | | | | | | | | | | | | | | | | | | | | | | | | | | | | | | | | | | | | | | | | | | | | | | | | | | | | | | | | |
| 56 | 0082 | 0091 | 0086 | 0106 | 0097 | 0109 | 0115 | | | | | | | | | | | | | | | | | | | | | | | | | | | | | | | | | | | | | | | | | | | | | | | | | | | | | | | | | | | | | | | | | | | | | | | | | | | | |
| 80 | 0081 | 0092 | 0085 | 0103 | 0097 | 0107 | 0112 | | | | | | | | | | | | | | | | | | | | | | | | | | | | | | | | | | | | | | | | | | | | | | | | | | | | | | | | | | | | | | | | | | | | | | | | | | | | |
| Static pressure | 40Pa | 30Pa | 50Pa | 100Pa | 65Pa | 120Pa | 150Pa | | | | | | | | | | | | | | | | | | | | | | | | | | | | | | | | | | | | | | | | | | | | | | | | | | | | | | | | | | | | | | | | | | | | | | | | | | | | |
| 90 | 0083 | 0082 | 0088 | 0098 | 0092 | 0100 | 0108 | | | | | | | | | | | | | | | | | | | | | | | | | | | | | | | | | | | | | | | | | | | | | | | | | | | | | | | | | | | | | | | | | | | | | | | | | | | | |
| 110 | 0095 | 0091 | 0093 | 0102 | 0097 | 0106 | 0112 | | | | | | | | | | | | | | | | | | | | | | | | | | | | | | | | | | | | | | | | | | | | | | | | | | | | | | | | | | | | | | | | | | | | | | | | | | | | |
| Static pressure | 50Pa | 30Pa | 40Pa | 100Pa | 65Pa | 120Pa | 150Pa | | | | | | | | | | | | | | | | | | | | | | | | | | | | | | | | | | | | | | | | | | | | | | | | | | | | | | | | | | | | | | | | | | | | | | | | | | | | |
| 140 | 0095 | 0091 | 0093 | 0102 | 0097 | 0106 | 0112 | | | | | | | | | | | | | | | | | | | | | | | | | | | | | | | | | | | | | | | | | | | | | | | | | | | | | | | | | | | | | | | | | | | | | | | | | | | | |
| 160 | 0095 | 0091 | 0093 | 0102 | 0097 | 0106 | 0112 | | | | | | | | | | | | | | | | | | | | | | | | | | | | | | | | | | | | | | | | | | | | | | | | | | | | | | | | | | | | | | | | | | | | | | | | | | | | |
| 14 | Central control mode selection | <ol style="list-style-type: none"> 1) Setting at the centerl controller side enables to select the contents which can be operated on the remote controller at indoor unit side. <p>* In case of the wireless type, the display lamp does not change but the contents are same. If operating an item which is prohibited by the central control mode from the remote controller, it is notified with the receive sound, Pi, Pi, Pi, Pi, Pi (5 times).</p> | | | | | | | | | | | | | | | | | | | | | | | | | | | | | | | | | | | | | | | | | | | | | | | | | | | | | | | | | | | | | | | | | | | | | | | | | | | | | | | | | |

| No. | Item | Outline of specifications | Remarks |
|-----|----------------------------|--|------------------|
| 15 | Energy-saving control | <ol style="list-style-type: none"> 1) Selecting [AUTO] mode enables an energy-saving to be operated. 2) When using the remote controller RBC-AMSU5 , "Energy saving operation" can be performed even in cooling mode and heating mode. 3) The setup temperature is shifted (corrected) in the range not to lose the comfort ability according to input values of various sensors. 4) Data (Input value room temp. Ta, Outside temp. To, Air volume, Indoor heat exchanger sensor temp. Tc) for 20 minutes are taken the average to calculate correction value of the setup temperature. 5) The setup temperature is shifted every 20 minutes, and the shifted range is as follows. In cooling time: +1.5 to - 1.0K In heating time: -1.5 to +1.0K | |
| 16 | Max. frequency cut control | <ol style="list-style-type: none"> 1) This control is operated by selecting [AUTO] operation mode. 2) COOL operation mode: It is controlled according to the following figure if To < 28°C. 3) HEAT operation mode: It is controlled according to the following figure if To > 15°C. <div style="display: flex; justify-content: space-around; align-items: flex-start;"> <div data-bbox="511 1009 933 1224" style="text-align: center;"> <p style="font-size: small;">Max. frequency is restricted to approximately the rated cooling frequency</p> </div> <div data-bbox="998 963 1429 1179" style="text-align: center;"> <p style="font-size: small;">Max. frequency is restricted to approximately the rated heating frequency</p> </div> </div> | |
| 17 | DC motor | <ol style="list-style-type: none"> 1) When the fan operation has started, positioning of the stator and the rotor are performed. (Moves slightly with tap sound) 2) The motor operates according to the command from the indoor controller. <p>Notes)</p> <ul style="list-style-type: none"> • When the fan rotates while the air conditioner stops due to entering of outside air, etc, the air conditioner may operate while the fan motor stops. • When a fan lock is found, the air conditioner stops, and an error is displayed. | Check code [P12] |

| No. | Item | Outline of specifications | Remarks | | | | | | | | | | | | | | |
|----------------------|--|--|---|-------------------------------|-----|------------|--------|--------------|------|---------------|------|-------------------------------|---------------|--------|------------|---------|--|
| 18 | Self-clean operation (Dry operation) | <p>1) When cooling operation mode (AUTO COOL, COOL, DRY) stopped, the following three self-clean operations are performed.</p> <table border="1" data-bbox="505 247 1433 433"> <thead> <tr> <th data-bbox="505 247 656 312">Compressor ON period</th> <th data-bbox="656 247 859 312">Self-clean operation period</th> <th data-bbox="859 247 980 312">FAN</th> <th data-bbox="980 247 1131 312">Drain pump</th> <th data-bbox="1131 247 1433 312">Louver</th> </tr> </thead> <tbody> <tr> <td data-bbox="505 312 656 353">0 to 10 min.</td> <td data-bbox="656 312 859 353">None</td> <td data-bbox="859 312 980 433" rowspan="3">Fan only (UL)</td> <td data-bbox="980 312 1131 433" rowspan="3">STOP</td> <td data-bbox="1131 312 1433 433" rowspan="3">Horizontal discharge position</td> </tr> <tr> <td data-bbox="505 353 656 394">10 to 60 min.</td> <td data-bbox="656 353 859 394">1 hour</td> </tr> <tr> <td data-bbox="505 394 656 433">60 min. to</td> <td data-bbox="656 394 859 433">2 hours</td> </tr> </tbody> </table> <p>2) During operation of self-clean,  lights on the wired remote controller screen. However the operation lamp (Green LED) goes off.</p> <p>3) To stop the self-clean operation, push twice the [ON/OFF] button on the remote controller continuously. (Stop the operation as compressor ON time in the table above: 10 minutes or below.)</p> <p>4) When the follower unit executes self-clean operation in the group connection, the segment of  is displayed on the wired remote controller screen via master unit.</p> <p>* If self-clean operation is not used, set invalidity (does not use) of the self-clean operation by changing [0001 (At shipment) of CODE No. (DN) [D3] to [0000].</p> <p>* To erase the  display during operation of self-clean, change CODE No. [D4] from [0000: Display (At shipment)] to [0001: Non-display].</p> | Compressor ON period | Self-clean operation period | FAN | Drain pump | Louver | 0 to 10 min. | None | Fan only (UL) | STOP | Horizontal discharge position | 10 to 60 min. | 1 hour | 60 min. to | 2 hours | It is recognized as [STOP] from the remote monitor side. |
| Compressor ON period | Self-clean operation period | FAN | Drain pump | Louver | | | | | | | | | | | | | |
| 0 to 10 min. | None | Fan only (UL) | STOP | Horizontal discharge position | | | | | | | | | | | | | |
| 10 to 60 min. | 1 hour | | | | | | | | | | | | | | | | |
| 60 min. to | 2 hours | | | | | | | | | | | | | | | | |
| 19 | Power saving (Energy saving operation) | <p>(In the case of RBC-AMTU3*)</p> <p>1) Turn on  button on the remote controller.</p> <p>2) During operation of save operation,  lights on the wired remote controller.</p> <p>3) During power save operation, the current release control is performed with the restriction ratio set in EEPROM on the outdoor unit.</p> <p>4) The restriction ratio can be set by keeping  button pushed for 4 seconds or more on the remote controller.</p> <p>5) When validating the power save operation, the next operation starts with power save operation valid because contents are held even when operation stops, operation mode changes or power supply is reset.</p> <p>6) The restriction ratio can be set by changing the setup data of CODE No. (DN) [C2] in the range of 50 to 100% (every 1%, Setting at shipment: 75%).</p> <p>* For RBC-AMSU5* remote controller, refer to its owner's manual.</p> | Carry out setting operation during stop of the unit; otherwise the unit stops operation. For the setup operation, refer to "Power saving mode" of Installation Manual. | | | | | | | | | | | | | | |
| 20 | Drain pump delay operation | When a cooling operation (including dry operation) is stopped, the drain pump continues operating for 5 minutes to reduce drain water in drain pan. | | | | | | | | | | | | | | | |

| No. | Item | Outline of specifications | Remarks | | | | | | | | | | | | | | | | | | |
|---------|---|---|---|------|------------------|--|------|---------|--|--------------|---|---------|------|--------------------------|--|------|------------|--|------|----------------|---|
| 21 | 8°C heating/ Frost protective operation | <p>1) This functional is intended for the cold latitudes and performs objective heating operation (8°C heating operation).</p> <p>2) This function is valid only for combination with the outdoor units (Super Digital Inverter (SDI) 4-series outdoor units).</p> <p>3) Using the indoor DN code [D1] (1 bit), Valid/Invalid of this function is set up at the customer's side. * The setup by DN code is Invalid [0]/Valid [1] and Invalid [0] has been set at the shipment.</p> <p>4) This operation is the heating operation which sets 8°C as the setup temperature of the target.</p> <p>5) This function starts operation by pushing temperature button  during heating operation; besides by pushing  button for 4 seconds or more after temperature reached the minimum set temperature.</p> <p>6) To stop/release this operation, select and execute one from the following operations.</p> <p>① Push  button: Heating operation (18°C setting) continues.</p> <p>② Push [START/STOP] button: Air conditioner stops. (Heating 18°C operation at the next start)</p> <p>③ Push  : Other operation mode is selected and the operation continues.</p> <p>7) As the setup temperature is 8°C and the human heating is not targeted, the cold air discharge preventive control (Item 7) is made invalid to suppress the intermittent operation.</p> <p>8) The settings of the air direction and air volume are changeable during this operation.</p> <p>9) The indoor fan stops to protect the compressor for 2 minutes after start of heating operation (Thermo-ON) by this function.</p> | <p>In a group connection, if there is even one combination with other unit, "This function is not provided." is displayed.</p> <p>The setup temperature jumps from [18] to [8].</p> | | | | | | | | | | | | | | | | | | |
| 22 | Occupancy sensor | <p>1) During the Occupancy sensor operation (DN code: [B5] [0001] and [B6] [0002 to 0005]), when there is no people in the Occupancy sensor range, it is automatically switched to the operation for the absence.</p> <p>2) The Occupancy sensor operation can change by [DN code : B6] as follows, and operates according to the operation at absent time, if time or absence of the setting contents continues. However time counting starts after the room temperature is stabilized. (after for 30 minutes operation)</p> <table border="1" data-bbox="604 1564 1115 1700"> <thead> <tr> <th>DN [B6]</th> <th>Data</th> <th>Setting contents</th> </tr> </thead> <tbody> <tr> <td></td> <td>0000</td> <td>Invalid</td> </tr> <tr> <td></td> <td>0001 to 0005</td> <td>30 minutes to 150 minutes (30 minutes each)</td> </tr> </tbody> </table> <p>3) The operation at absent time can be changed by [DN code : B7].</p> <table border="1" data-bbox="604 1787 1115 1889"> <thead> <tr> <th>DN [B7]</th> <th>Data</th> <th>Operation at absent time</th> </tr> </thead> <tbody> <tr> <td></td> <td>0000</td> <td>Circulator</td> </tr> <tr> <td></td> <td>0001</td> <td>Operation stop</td> </tr> </tbody> </table> <p>4) If the operation at absent time stops during group operation, or absence is fixed in each system, the operation starts circular operation once, and then the operation stops when absence was determined on all group.</p> <p>* DN [06] and DN [B7] can be set on the "Occupancy sensor" menu of the wired remote controller RBC - AMSU5*.</p> | DN [B6] | Data | Setting contents | | 0000 | Invalid | | 0001 to 0005 | 30 minutes to 150 minutes (30 minutes each) | DN [B7] | Data | Operation at absent time | | 0000 | Circulator | | 0001 | Operation stop | <p>The Occupancy sensor can be set up by wired remote controller RBC-AMSU5*</p> |
| DN [B6] | Data | Setting contents | | | | | | | | | | | | | | | | | | | |
| | 0000 | Invalid | | | | | | | | | | | | | | | | | | | |
| | 0001 to 0005 | 30 minutes to 150 minutes (30 minutes each) | | | | | | | | | | | | | | | | | | | |
| DN [B7] | Data | Operation at absent time | | | | | | | | | | | | | | | | | | | |
| | 0000 | Circulator | | | | | | | | | | | | | | | | | | | |
| | 0001 | Operation stop | | | | | | | | | | | | | | | | | | | |

| No. | Item | Outline of specifications | Remarks | | | | | | | | | | | | | | | |
|----------|---|--|---|------|---|--|------|-------------------------------|--|------|--|--|------|-----|--|------|---------------|--|
| 23 | Soft cooling | <p>* Wired remote controller : RBC-AMSU5* is required.</p> <ol style="list-style-type: none"> 1) Sensation of draft can be suppressed by controlling performance and correcting the louver angle during cooling operation. 2) However, it may not cool well because the operation will be performed with the cooling capacity suppressed. 3) Perform operations from the remote controller menu to use soft cooling. | This function cannot be used with remote controllers that are not RBC-AMSU5*. | | | | | | | | | | | | | | | |
| 24 | Dual set point (AUTO mode) | <ol style="list-style-type: none"> 1) The temperature for heating operations and cooling operations can be set separately in AUTO mode when dual set point is valid. 2) The compressor will turn off (thermostat-OFF) when reaching the set temperature for heating operations and cooling operations. 3) Set CODE No. (DN) [77] to enable Dual set point. <table border="1" data-bbox="557 719 1115 831" style="margin-left: 20px;"> <tr> <td style="text-align: center;">DN [77]</td> <td style="text-align: center;">Data</td> <td style="text-align: center;">Dual set point</td> </tr> <tr> <td></td> <td style="text-align: center;">0000</td> <td style="text-align: center;">Unavailable (Factory default)</td> </tr> <tr> <td></td> <td style="text-align: center;">0002</td> <td style="text-align: center;">Available</td> </tr> </table> | DN [77] | Data | Dual set point | | 0000 | Unavailable (Factory default) | | 0002 | Available | | | | | | | |
| DN [77] | Data | Dual set point | | | | | | | | | | | | | | | | |
| | 0000 | Unavailable (Factory default) | | | | | | | | | | | | | | | | |
| | 0002 | Available | | | | | | | | | | | | | | | | |
| 25 | Fan speed setting when thermostat-OFF in cooling mode | <ol style="list-style-type: none"> 1) The fan speed for when the room temperature reaches the set temperature in cooling operations and dry mode can be set. 2) Change the fan speed by operating CODE No. (DN)[9A]. 3) Select "Remote controller setting" if changing fan speed is not desired during thermostat-OFF. <p>* When selecting "0002" (OFF), make sure to use the Remote controller sensor or Remote sensor unit so that the room temperature can be detected properly.</p> <table border="1" data-bbox="557 1189 1115 1435" style="margin-left: 20px;"> <tr> <td style="text-align: center;">DN [9A]</td> <td style="text-align: center;">Data</td> <td style="text-align: center;">Fan speed when thermostat-OFF in cooling mode</td> </tr> <tr> <td></td> <td style="text-align: center;">0000</td> <td style="text-align: center;">Remote controller setting</td> </tr> <tr> <td></td> <td style="text-align: center;">0001</td> <td style="text-align: center;">Extremely low speed (UL) (Factory default)</td> </tr> <tr> <td></td> <td style="text-align: center;">0002</td> <td style="text-align: center;">OFF</td> </tr> <tr> <td></td> <td style="text-align: center;">0003</td> <td style="text-align: center;">Low speed (L)</td> </tr> </table> | DN [9A] | Data | Fan speed when thermostat-OFF in cooling mode | | 0000 | Remote controller setting | | 0001 | Extremely low speed (UL) (Factory default) | | 0002 | OFF | | 0003 | Low speed (L) | |
| DN [9A] | Data | Fan speed when thermostat-OFF in cooling mode | | | | | | | | | | | | | | | | |
| | 0000 | Remote controller setting | | | | | | | | | | | | | | | | |
| | 0001 | Extremely low speed (UL) (Factory default) | | | | | | | | | | | | | | | | |
| | 0002 | OFF | | | | | | | | | | | | | | | | |
| | 0003 | Low speed (L) | | | | | | | | | | | | | | | | |
| 26 | Draft prevention control | <ol style="list-style-type: none"> 1) This function prevents cold air from descending from the air outlet of the air conditioner when defrosting operations are being performed and the indoor unit fan is stopped, by closing the louver. 2) Valid/Invalid can be switched by CODE No. (DN) [121]. 3) When defrosting operations start at the outdoor unit, the indoor fan will stop since the temperature that the TC/TCJ sensor detects falls and the cold air draft prevention control is performed (see Item 7). When this function is valid, the louver will close. 4) After the defrosting operations end and normal heating operations start, causing the temperature that the TC/TCJ sensor detects to rise and the indoor fan to start operations, the louver will open at a horizontal angle, and thereafter move to the point that is set by the remote controller. <table border="1" data-bbox="557 1935 1115 2047" style="margin-left: 20px;"> <tr> <td style="text-align: center;">DN [121]</td> <td style="text-align: center;">Data</td> <td style="text-align: center;">Draft prevention control</td> </tr> <tr> <td></td> <td style="text-align: center;">0000</td> <td style="text-align: center;">Unavailable</td> </tr> <tr> <td></td> <td style="text-align: center;">0001</td> <td style="text-align: center;">Available (Factory default)</td> </tr> </table> | DN [121] | Data | Draft prevention control | | 0000 | Unavailable | | 0001 | Available (Factory default) | | | | | | | |
| DN [121] | Data | Draft prevention control | | | | | | | | | | | | | | | | |
| | 0000 | Unavailable | | | | | | | | | | | | | | | | |
| | 0001 | Available (Factory default) | | | | | | | | | | | | | | | | |

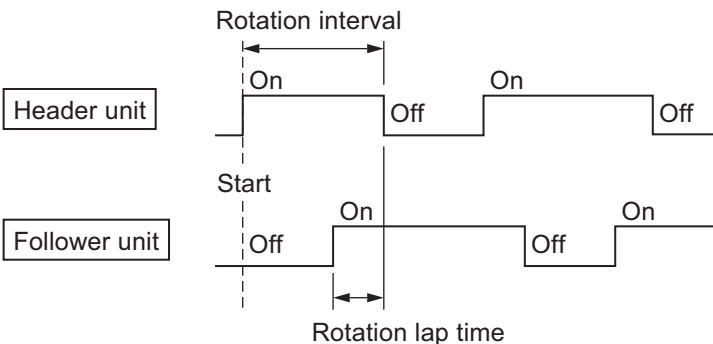
| No. | Item | Outline of specifications | Remarks | | | | | | | | | | | | | |
|------------------|-----------------------------------|--|---------|------|--------------------|--|------|----------|--|------|-----------------------------|------------------|------------------------|----|-----------------------------------|---|
| 27 | Communication type setting | <p>1) Communication type will be determined automatically by the combination of the indoor unit and the remote controller/ remote sensor.</p> <p>2) However, this must be set to TCC-Link when connecting to a central control device exclusively for TCC-Link. Set the CODE No. (DN) [FC] to "0000" (TCC-Link).</p> <table border="1" data-bbox="557 416 1115 524"> <tr> <td>DN [FC]</td> <td>Data</td> <td>Communication type</td> </tr> <tr> <td></td> <td>0000</td> <td>TCC-Link</td> </tr> <tr> <td></td> <td>0004</td> <td>TU2C-Link (Factory default)</td> </tr> </table> <p>3) The communication protocol used in the operations can be checked by "Monitor function" on the wired remote controller.</p> <table border="1" data-bbox="456 611 1003 714"> <tr> <td>Monitor CODE No.</td> <td>Communication protocol</td> </tr> <tr> <td>B9</td> <td>0000: TCC-Link 0001: TU2C-Link</td> </tr> </table> <p>* Refer to page 86 or the manual for the remote controller for operation methods of "Monitor function".</p> | DN [FC] | Data | Communication type | | 0000 | TCC-Link | | 0004 | TU2C-Link (Factory default) | Monitor CODE No. | Communication protocol | B9 | 0000: TCC-Link 0001: TU2C-Link | <ul style="list-style-type: none"> When performing group control in combination with a TCC-Link dedicated indoor unit (other than RAV-HM***), change the communication type to TCC-Link. |
| DN [FC] | Data | Communication type | | | | | | | | | | | | | | |
| | 0000 | TCC-Link | | | | | | | | | | | | | | |
| | 0004 | TU2C-Link (Factory default) | | | | | | | | | | | | | | |
| Monitor CODE No. | Communication protocol | | | | | | | | | | | | | | | |
| B9 | 0000: TCC-Link 0001: TU2C-Link | | | | | | | | | | | | | | | |
| 28 | Rotation / backup operation | <p>1) Rotation control which alternately performs operations is available only when the following conditions are satisfied.</p> <ul style="list-style-type: none"> Only two systems are connected Each system is connected singly <p>2) If a trouble occurs in either of the systems, the other system will start to operate. (backup operation)</p> <p>3) When performing rotation control, the DN code [1C1] for the header unit must be set to "0001" (valid).</p> <p>4) The intervals to switch the operations can be set by setting the CODE No. (DN) [1C2] in increments of days (maximum 28 days).</p> <p>5) Start the other operation 30 minutes before the end of one operation. Rotation lap time can be set in increments of 10 minutes by setting the CODE No. (DN) [1C3] (maximum 70 minutes).</p> <p>6) A check code will show on the remote controller if backup operations are being performed due to a trouble.</p> <p>7) If the following trouble occurs, backup operations will not be performed, and the entire system will stop.</p> <ul style="list-style-type: none"> E03 : Remote controller - indoor unit communication trouble <p>8) If the following trouble occurs, only the header unit will perform operations.</p> <ul style="list-style-type: none"> E18 : Indoor header - follower unit communication trouble <p>* This function is not guaranteed to protect the devices within the room of air conditioning.</p>  <p>The diagram illustrates the rotation control sequence. It shows two horizontal axes: 'Header unit' and 'Follower unit'. The 'Header unit' starts in an 'On' state. A horizontal double-headed arrow labeled 'Rotation interval' spans the duration of its 'On' state. When the 'Header unit' turns 'Off', the 'Follower unit' turns 'On'. A horizontal double-headed arrow labeled 'Rotation lap time' spans the duration of the 'Follower unit' being 'On'. The 'Header unit' then turns 'On' again, and the 'Follower unit' turns 'Off'. This cycle repeats.</p> | | | | | | | | | | | | | | |

| No. | Item | Outline of specifications | Remarks | | | | | | | | | | | | | | | | | | | | | | | |
|---------------------|---|---|----------|------|--------------------|--|------|-------------------------------|--|------|-----------------------------|----------|------|-------------------|--|--------------|---|----------|------|-------------------|--|--------------|--|---------------------|---|--|
| 28 | Rotation / backup operation (Continued) | <table border="1" data-bbox="557 232 1115 342"> <tr> <td data-bbox="557 232 671 271">DN [1C1]</td> <td data-bbox="671 232 786 271">Data</td> <td data-bbox="786 232 1115 271">Rotation operation</td> </tr> <tr> <td></td> <td data-bbox="671 271 786 309">0000</td> <td data-bbox="786 271 1115 309">Unavailable (Factory default)</td> </tr> <tr> <td></td> <td data-bbox="671 309 786 342">0001</td> <td data-bbox="786 309 1115 342">Available</td> </tr> </table> <table border="1" data-bbox="557 365 1115 501"> <tr> <td data-bbox="557 365 671 403">DN [1C2]</td> <td data-bbox="671 365 786 403">Data</td> <td data-bbox="786 365 1115 403">Rotation interval</td> </tr> <tr> <td></td> <td data-bbox="671 403 786 501">0001 to 0028</td> <td data-bbox="786 403 1115 501">1 day to 28days 0001: 1day (Factory default)</td> </tr> </table> <table border="1" data-bbox="557 524 1115 660"> <tr> <td data-bbox="557 524 671 562">DN [1C3]</td> <td data-bbox="671 524 786 562">Data</td> <td data-bbox="786 524 1115 562">Rotation lap time</td> </tr> <tr> <td></td> <td data-bbox="671 562 786 660">0000 to 0007</td> <td data-bbox="786 562 1115 660">0003: 30 minutes (Factory default) 0 to 70 minutes (10 minutes each)</td> </tr> </table> <p data-bbox="421 678 1070 736">9) The state of rotation operations can be checked by the "Monitor function" within the wired remote controller.</p> <table border="1" data-bbox="453 752 1115 913"> <tr> <td data-bbox="453 752 600 913">Monitor CODE No. E9</td> <td data-bbox="600 752 1115 913"> Rotation operation - - - -: Unavailable 0000: Rotation operation OFF 0001: Rotation operation ON, Unit ON 0002: Rotation operation ON, Unit OFF </td> </tr> </table> <p data-bbox="421 929 1102 987">* Refer to page 82 or the manual for the remote controller for operation method of "Monitor function".</p> | DN [1C1] | Data | Rotation operation | | 0000 | Unavailable (Factory default) | | 0001 | Available | DN [1C2] | Data | Rotation interval | | 0001 to 0028 | 1 day to 28days 0001: 1day (Factory default) | DN [1C3] | Data | Rotation lap time | | 0000 to 0007 | 0003: 30 minutes (Factory default) 0 to 70 minutes (10 minutes each) | Monitor CODE No. E9 | Rotation operation - - - -: Unavailable 0000: Rotation operation OFF 0001: Rotation operation ON, Unit ON 0002: Rotation operation ON, Unit OFF | |
| DN [1C1] | Data | Rotation operation | | | | | | | | | | | | | | | | | | | | | | | | |
| | 0000 | Unavailable (Factory default) | | | | | | | | | | | | | | | | | | | | | | | | |
| | 0001 | Available | | | | | | | | | | | | | | | | | | | | | | | | |
| DN [1C2] | Data | Rotation interval | | | | | | | | | | | | | | | | | | | | | | | | |
| | 0001 to 0028 | 1 day to 28days 0001: 1day (Factory default) | | | | | | | | | | | | | | | | | | | | | | | | |
| DN [1C3] | Data | Rotation lap time | | | | | | | | | | | | | | | | | | | | | | | | |
| | 0000 to 0007 | 0003: 30 minutes (Factory default) 0 to 70 minutes (10 minutes each) | | | | | | | | | | | | | | | | | | | | | | | | |
| Monitor CODE No. E9 | Rotation operation - - - -: Unavailable 0000: Rotation operation OFF 0001: Rotation operation ON, Unit ON 0002: Rotation operation ON, Unit OFF | | | | | | | | | | | | | | | | | | | | | | | | | |
| 29 | Defrost shift | <p data-bbox="421 1077 1150 1218">1) This control is to change the starting time of defrosting operations to avoid temperature drop when multiple air conditioners that belong to refrigerant systems are installed in the same space, and the defrosting operations there of start at the same time.</p> <p data-bbox="421 1223 1086 1281">2) Set the CODE No. (DN) [120] to "0001" (valid) for all the indoor units that are group-operated to use this function.</p> <p data-bbox="421 1285 1134 1361">3) The outdoor unit must be compatible to use this function. Check the installation manual and service manual for further information.</p> <p data-bbox="421 1366 1134 1451">* The defrosting operations may be performed at the same time to prevent incomplete defrosting in environments where the temperature of the outdoor unit is extremely low or the like.</p> <table border="1" data-bbox="557 1485 1115 1594"> <tr> <td data-bbox="557 1485 671 1523">DN [120]</td> <td data-bbox="671 1485 786 1523">Data</td> <td data-bbox="786 1485 1115 1523">Defrost shift</td> </tr> <tr> <td></td> <td data-bbox="671 1523 786 1561">0000</td> <td data-bbox="786 1523 1115 1561">Unavailable</td> </tr> <tr> <td></td> <td data-bbox="671 1561 786 1594">0001</td> <td data-bbox="786 1561 1115 1594">Available (Factory default)</td> </tr> </table> | DN [120] | Data | Defrost shift | | 0000 | Unavailable | | 0001 | Available (Factory default) | | | | | | | | | | | | | | | |
| DN [120] | Data | Defrost shift | | | | | | | | | | | | | | | | | | | | | | | | |
| | 0000 | Unavailable | | | | | | | | | | | | | | | | | | | | | | | | |
| | 0001 | Available (Factory default) | | | | | | | | | | | | | | | | | | | | | | | | |

| No. | Item | Outline of specifications | Remarks | | | | | | | | | |
|---------|-------------|---|---------|------|-------------|--|------|-------------------------------|--|------|-----------|--|
| 30 | Power shift | <p>1) This is control that, when air conditioners in different systems are installed in the same space controlled in a group, and the load within the space is imbalanced, lowers the used power within the whole group by limiting air conditioners having compressors that are operating at a highly inefficient frequency, and making up for insufficient performance by operating other air conditioners.</p> <p>2) When using this function, set the unit CODE No. (DN) [FB] to "0001" (valid) for all indoor units within the controlled group.</p> <p>3) When the load is determined to be unbalanced after a defined period of normal cooling operations or heating operations, the frequency of the outdoor unit compressor which is operating under the highest load will be limited. This function is invalid with auto cooling operations, dry operations, and air fan operations.</p> <p>4) The frequency is limited 10% at the maximum, in accordance with the temperature difference of TA (indoor temperature) and Ts (set temperature). $\Delta t = TA - Ts$ (during cooling operations), $\Delta t = Ts - TA$ (during heating operations)</p> <p>5) The limitation will be lifted when either of the following conditions are satisfied.</p> <ul style="list-style-type: none"> • Any one of the set temperature, fan speed, wind direction, or the operation mode is changed from the remote controller. • Defrosting operations are performed within the group • $\Delta t > 3^{\circ}\text{C}$ has been satisfied for five minutes <p>6) The limitation will continue until the operations are stopped or the operation mode is changed for the air conditioners under the limitation.</p> <table border="1" data-bbox="557 1093 1115 1205"> <tr> <td data-bbox="448 1093 557 1128">DN [FB]</td> <td data-bbox="557 1093 671 1128">Data</td> <td data-bbox="671 1093 1115 1128">Power shift</td> </tr> <tr> <td></td> <td data-bbox="557 1128 671 1164">0000</td> <td data-bbox="671 1128 1115 1164">Unavailable (Factory default)</td> </tr> <tr> <td></td> <td data-bbox="557 1164 671 1200">0001</td> <td data-bbox="671 1164 1115 1200">Available</td> </tr> </table> | DN [FB] | Data | Power shift | | 0000 | Unavailable (Factory default) | | 0001 | Available | |
| DN [FB] | Data | Power shift | | | | | | | | | | |
| | 0000 | Unavailable (Factory default) | | | | | | | | | | |
| | 0001 | Available | | | | | | | | | | |

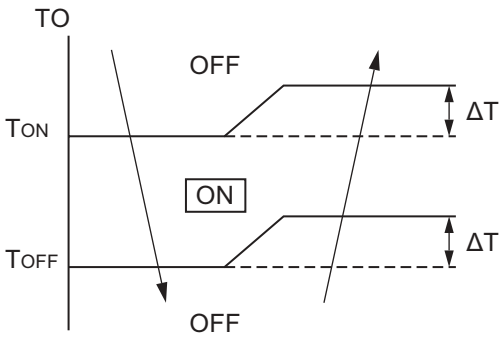
| No. | Item | Outline of specifications | Remarks | | | | | | | | | | | | | | | | | | | | | | | | | | | | | |
|------------------------|---|---|----------|------|--------------|--|------|-------------------------------|--|------|-----------|----------|------|---|--|---------------|--|----------|------|---|--|---------------|--|----------|------|------------------------------------|--|--------------|--|------------------------|---|--|
| 31 | Free cooling | <p>1) The external device can be operated in accordance with the outdoor temperature in cooling operations. Energy saving operations can be realized even if a cooling load exists in the winter, by combining a device that uses the outdoor temperature.</p> <p>2) This function is valid by setting the CODE No. (DN) [1C8] from the wired remote controller, and when the outdoor temperature satisfies certain conditions, the output for the CN32 connector on the indoor P.C. board will turn ON.</p> <p>* Use processed air when taking in fresh air. Watch for condensation of devices when taking in fresh air at low temperatures.</p> <table border="1" data-bbox="555 593 1115 703"> <tr> <td>DN [1C8]</td> <td>Data</td> <td>Free cooling</td> </tr> <tr> <td></td> <td>0000</td> <td>Unavailable (Factory default)</td> </tr> <tr> <td></td> <td>0001</td> <td>Available</td> </tr> </table>  <p>3) The temperature condition can be set with the following CODE No. (DN).</p> <table border="1" data-bbox="555 1182 1115 1328"> <tr> <td>DN [1C9]</td> <td>Data</td> <td>T_{ON} : Free cooling ON temp.[°C]</td> </tr> <tr> <td></td> <td>-0015 to 0029</td> <td>0016:16°C (Factory default) -15°C to 29°C (1°C each)</td> </tr> </table> <table border="1" data-bbox="555 1346 1115 1491"> <tr> <td>DN [1CA]</td> <td>Data</td> <td>T_{OFF} : Free cooling OFF temp.[°C]</td> </tr> <tr> <td></td> <td>-0015 to 0029</td> <td>0010:10°C (Factory default) -15°C to 29°C (1°C each)</td> </tr> </table> <table border="1" data-bbox="555 1509 1115 1655"> <tr> <td>DN [1CB]</td> <td>Data</td> <td>ΔT : ON/OFF differential temp.[°C]</td> </tr> <tr> <td></td> <td>0000 to 0010</td> <td>0002: 2°C (Factory default) 0°C to 10°C (1°C each)</td> </tr> </table> <p>4) The output for CN32 will turn OFF if there is a trouble in the TO sensor.</p> <p>5) The output state can be checked from “Monitor function” on the wired remote controller.</p> <p>* Refer to page 82 or or the manual for the remote controller for operation methods of “Monitor function”.</p> <table border="1" data-bbox="456 1883 1118 2011"> <tr> <td>Monitor CODE No. E6</td> <td>Free cooling output --- : Unavailable 0000: OFF 0001: ON</td> </tr> </table> | DN [1C8] | Data | Free cooling | | 0000 | Unavailable (Factory default) | | 0001 | Available | DN [1C9] | Data | T _{ON} : Free cooling ON temp.[°C] | | -0015 to 0029 | 0016:16°C (Factory default) -15°C to 29°C (1°C each) | DN [1CA] | Data | T _{OFF} : Free cooling OFF temp.[°C] | | -0015 to 0029 | 0010:10°C (Factory default) -15°C to 29°C (1°C each) | DN [1CB] | Data | ΔT : ON/OFF differential temp.[°C] | | 0000 to 0010 | 0002: 2°C (Factory default) 0°C to 10°C (1°C each) | Monitor CODE No. E6 | Free cooling output --- : Unavailable 0000: OFF 0001: ON | |
| DN [1C8] | Data | Free cooling | | | | | | | | | | | | | | | | | | | | | | | | | | | | | | |
| | 0000 | Unavailable (Factory default) | | | | | | | | | | | | | | | | | | | | | | | | | | | | | | |
| | 0001 | Available | | | | | | | | | | | | | | | | | | | | | | | | | | | | | | |
| DN [1C9] | Data | T _{ON} : Free cooling ON temp.[°C] | | | | | | | | | | | | | | | | | | | | | | | | | | | | | | |
| | -0015 to 0029 | 0016:16°C (Factory default) -15°C to 29°C (1°C each) | | | | | | | | | | | | | | | | | | | | | | | | | | | | | | |
| DN [1CA] | Data | T _{OFF} : Free cooling OFF temp.[°C] | | | | | | | | | | | | | | | | | | | | | | | | | | | | | | |
| | -0015 to 0029 | 0010:10°C (Factory default) -15°C to 29°C (1°C each) | | | | | | | | | | | | | | | | | | | | | | | | | | | | | | |
| DN [1CB] | Data | ΔT : ON/OFF differential temp.[°C] | | | | | | | | | | | | | | | | | | | | | | | | | | | | | | |
| | 0000 to 0010 | 0002: 2°C (Factory default) 0°C to 10°C (1°C each) | | | | | | | | | | | | | | | | | | | | | | | | | | | | | | |
| Monitor CODE No. E6 | Free cooling output --- : Unavailable 0000: OFF 0001: ON | | | | | | | | | | | | | | | | | | | | | | | | | | | | | | | |

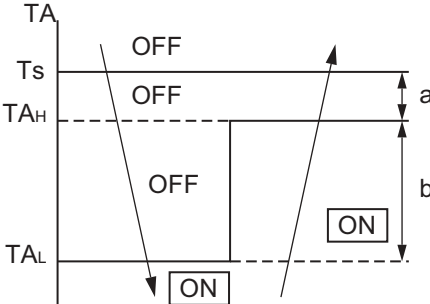
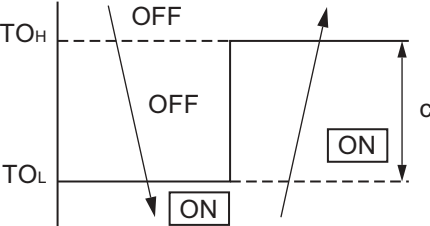
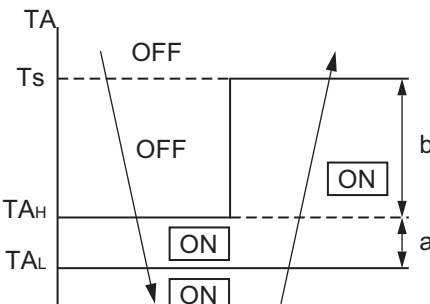
| No. | Item | Outline of specifications | Remarks |
|-----|-------------------|---|---|
| 32 | Secondary heating | <p>Secondary heating can be used while heating operations are performed.</p> <p><Control Outline (Normal Mode)></p> <ol style="list-style-type: none"> 1) If the difference between the indoor temperature and the outdoor temperature is large while the air conditioner is operating, turn ON the secondary heating. 2) This function is valid when the CODE No. (DN) [DC] is set to "0001" (0.5°C) to "0010" (5.0°C) using the wired remote controller, and the output to the external heating source will turn ON if the room temperature satisfies the condition. 3) The output will always stay ON while defrosting operations are being performed.  <ol style="list-style-type: none"> 4) The output can be turned on by the outdoor temperature when CODE No. (DN) [C7] is set to "0001" (1°C) to "0010" (10°C) using the wired remote controller.  <p><Control Outline (Flip Mode)></p> <ol style="list-style-type: none"> 1) If the difference between the room temperature and the set temperature is large while using secondary heating, run the air conditioner. 2) This function is valid when the CODE No. (DN) [C5] is set to "0001" (Flip mode) or the CODE No. (DN) [C7] is set to "0001" (1°C) to "0010" (10°C) using the wired remote controller, and when the output is switched ON when the room temperature satisfies the conditions. <p>* The outdoor temperature determination is invalid whilst this control is performed.</p>  | <p>TA_H : Temp.set air high (= Ts - a) TA_L : Temp.set air low (= TA_H - b)</p> <p>TO_H : Temp.set out high TO_L : Temp.set out low (= TO_H - c)</p> |

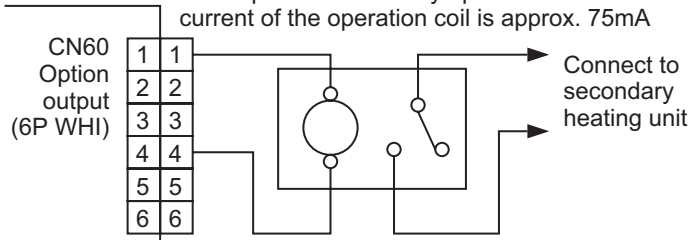
| No. | Item | Outline of specifications | Remarks | | | | | | | | | | | | | | | | | | | | | | | | | | | | | | | | | | | | | | | | | |
|------------------------|---|---|---------|------|------------------------|--|------|-------------------------------|--|------|-----------|---------|------|---|--|---------------------|---|---------|------|--|--|------|-------------------------------|--|--------------------|---------------------------|---------|------|--|--|--------------------|---|---------|------|--|--|------|-------------------------------|--|--------------------|---------------------------|------------------------|---|--|
| 32 | Secondary heating (Continued) | <table border="1" data-bbox="560 241 1120 349"> <tr> <td>DN [C5]</td> <td>Data</td> <td>Secondary heating mode</td> </tr> <tr> <td></td> <td>0000</td> <td>Normal mode (Factory default)</td> </tr> <tr> <td></td> <td>0001</td> <td>Flip mode</td> </tr> </table> <table border="1" data-bbox="560 378 1120 517"> <tr> <td>DN [C6]</td> <td>Data</td> <td>TO_H: Set temp. out (high) [°C]</td> </tr> <tr> <td></td> <td>-0015 to 0015</td> <td>"-0015": -15°C to "0015": 15°C "0000": 0°C (Factory default)</td> </tr> </table> <table border="1" data-bbox="560 546 1120 719"> <tr> <td>DN [C7]</td> <td>Data</td> <td>c : TO_H - TO_L [°C]</td> </tr> <tr> <td></td> <td>0000</td> <td>Unavailable (Factory default)</td> </tr> <tr> <td></td> <td>0001 to 0010</td> <td>0001: 1°C to "0010": 10°C</td> </tr> </table> <table border="1" data-bbox="560 748 1120 887"> <tr> <td>DN [DB]</td> <td>Data</td> <td>b : TA_H - TA_L [°C]</td> </tr> <tr> <td></td> <td>0001 to 0010</td> <td>"0001": 0.5°C to "0010": 5.0°C "0006": 3°C (Factory default)</td> </tr> </table> <table border="1" data-bbox="560 916 1120 1122"> <tr> <td>DN [DC]</td> <td>Data</td> <td>a : Ts - TA_H (Normal mode)[°C] TA_L - Ts (Flip mode)[°C]</td> </tr> <tr> <td></td> <td>0000</td> <td>Unavailable (Factory default)</td> </tr> <tr> <td></td> <td>0001 to 0010</td> <td>0001: 1°C to "0010": 10°C</td> </tr> </table> <p data-bbox="427 1126 528 1153"><Wiring></p> <p data-bbox="427 1155 1070 1211">1) Use ① - ④ pin (Cooling output, DC 12 V) of CN60 on indoor P.C. board for output.</p> <div data-bbox="427 1227 1126 1608"> <p data-bbox="603 1227 1126 1312">Relay (DC12V, procured locally) Corresponds to the relay up to one that the rated current of the operation coil is approx. 75mA</p>  <p data-bbox="427 1552 580 1608">Indoor control P.C. board</p> <p data-bbox="612 1529 1110 1608">Note) Determine the cable length between the indoor control P.C.board and the relay within 2m.</p> </div> <p data-bbox="427 1641 1150 1816">2) If there is no CN60 on the P.C. board (MCC-1720 model), install separately-sold Application control kit (TCB-PCUC2E), and use "OUT1 to OUT3" of the Signal output terminal block (TB1). At this time, select "1" (Cool dry output) for "SW1 to SW3". Following the installation manual of the Application control kit for detailed contents relating to wiring.</p> <p data-bbox="427 1843 1150 1928">* The output state can be checked from "Monitor function" on the wired remote controller. See page 82 or the manual for the remote controller for operation methods of "Monitor function".</p> <table border="1" data-bbox="459 1944 1120 2074"> <tr> <td>Monitor CODE No. E5</td> <td>Secondary heating output ---: Unavailable 0000: OFF 0001: ON</td> </tr> </table> | DN [C5] | Data | Secondary heating mode | | 0000 | Normal mode (Factory default) | | 0001 | Flip mode | DN [C6] | Data | TO _H : Set temp. out (high) [°C] | | -0015 to 0015 | "-0015": -15°C to "0015": 15°C "0000": 0°C (Factory default) | DN [C7] | Data | c : TO _H - TO _L [°C] | | 0000 | Unavailable (Factory default) | | 0001 to 0010 | 0001: 1°C to "0010": 10°C | DN [DB] | Data | b : TA _H - TA _L [°C] | | 0001 to 0010 | "0001": 0.5°C to "0010": 5.0°C "0006": 3°C (Factory default) | DN [DC] | Data | a : Ts - TA _H (Normal mode)[°C] TA _L - Ts (Flip mode)[°C] | | 0000 | Unavailable (Factory default) | | 0001 to 0010 | 0001: 1°C to "0010": 10°C | Monitor CODE No. E5 | Secondary heating output ---: Unavailable 0000: OFF 0001: ON | |
| DN [C5] | Data | Secondary heating mode | | | | | | | | | | | | | | | | | | | | | | | | | | | | | | | | | | | | | | | | | | |
| | 0000 | Normal mode (Factory default) | | | | | | | | | | | | | | | | | | | | | | | | | | | | | | | | | | | | | | | | | | |
| | 0001 | Flip mode | | | | | | | | | | | | | | | | | | | | | | | | | | | | | | | | | | | | | | | | | | |
| DN [C6] | Data | TO _H : Set temp. out (high) [°C] | | | | | | | | | | | | | | | | | | | | | | | | | | | | | | | | | | | | | | | | | | |
| | -0015 to 0015 | "-0015": -15°C to "0015": 15°C "0000": 0°C (Factory default) | | | | | | | | | | | | | | | | | | | | | | | | | | | | | | | | | | | | | | | | | | |
| DN [C7] | Data | c : TO _H - TO _L [°C] | | | | | | | | | | | | | | | | | | | | | | | | | | | | | | | | | | | | | | | | | | |
| | 0000 | Unavailable (Factory default) | | | | | | | | | | | | | | | | | | | | | | | | | | | | | | | | | | | | | | | | | | |
| | 0001 to 0010 | 0001: 1°C to "0010": 10°C | | | | | | | | | | | | | | | | | | | | | | | | | | | | | | | | | | | | | | | | | | |
| DN [DB] | Data | b : TA _H - TA _L [°C] | | | | | | | | | | | | | | | | | | | | | | | | | | | | | | | | | | | | | | | | | | |
| | 0001 to 0010 | "0001": 0.5°C to "0010": 5.0°C "0006": 3°C (Factory default) | | | | | | | | | | | | | | | | | | | | | | | | | | | | | | | | | | | | | | | | | | |
| DN [DC] | Data | a : Ts - TA _H (Normal mode)[°C] TA _L - Ts (Flip mode)[°C] | | | | | | | | | | | | | | | | | | | | | | | | | | | | | | | | | | | | | | | | | | |
| | 0000 | Unavailable (Factory default) | | | | | | | | | | | | | | | | | | | | | | | | | | | | | | | | | | | | | | | | | | |
| | 0001 to 0010 | 0001: 1°C to "0010": 10°C | | | | | | | | | | | | | | | | | | | | | | | | | | | | | | | | | | | | | | | | | | |
| Monitor CODE No. E5 | Secondary heating output ---: Unavailable 0000: OFF 0001: ON | | | | | | | | | | | | | | | | | | | | | | | | | | | | | | | | | | | | | | | | | | | |

6-3. Indoor Print Circuit Board

<MCC-1720>

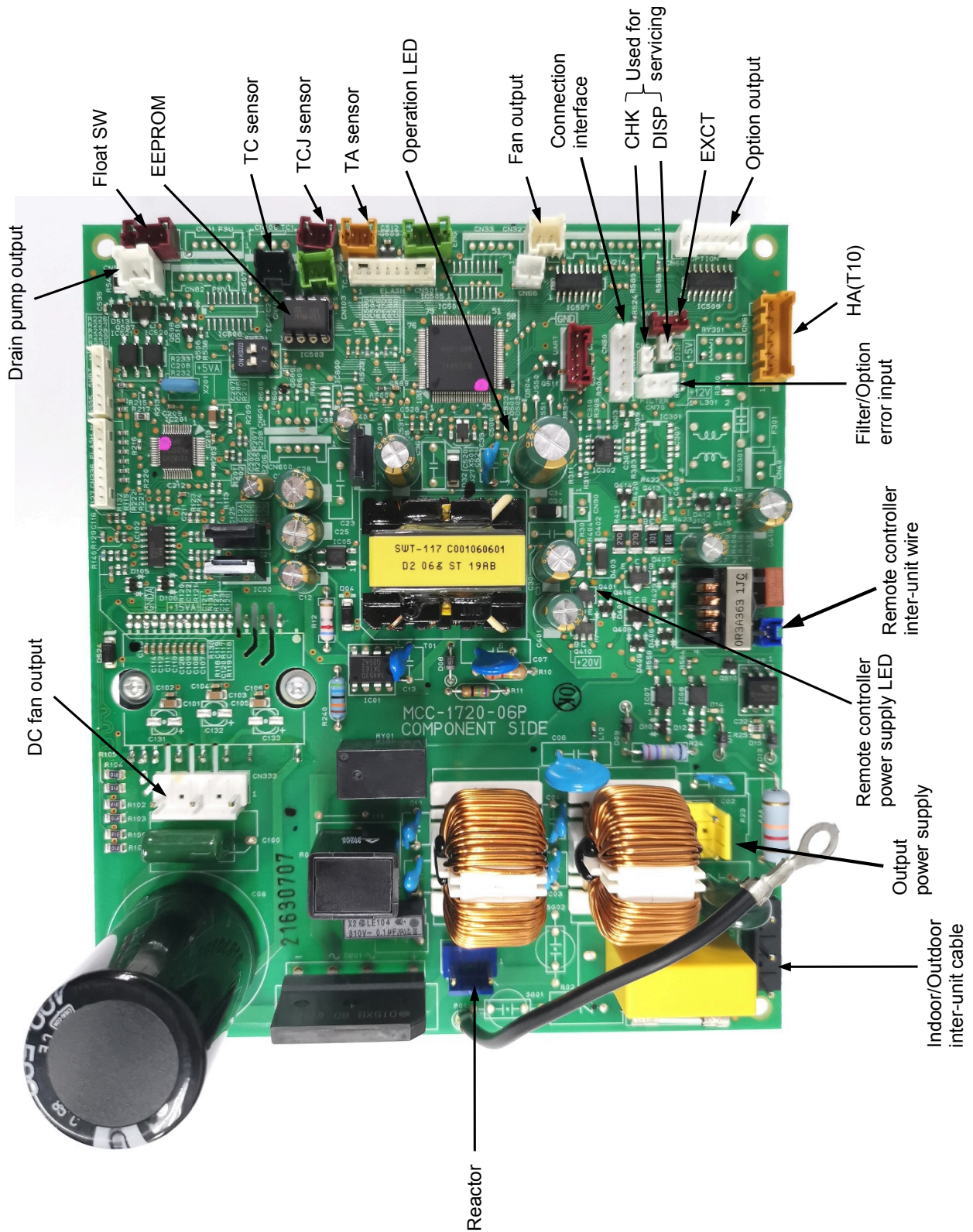

Indoor P.C. Board Optional Connector Specifications (MCC-1720)

| Function | Connector No. | Pin No. | Specification | Remarks |
|------------------------|---------------|---------|-----------------------------------|---|
| Fan output | CN32 | 1 | DC12 V | Factory default setting: ON when indoor unit in operation and OFF when indoor unit at rest * Fan can be operated on its own by pressing FAN button on remote controller (DN = 31) |
| | | 2 | Output | |
| HA | CN61 | 1 | Start / stop input | Start / stop input for HA (J01: In place / Removed = Pulse input (factory default) / Step input) |
| | | 2 | 0V(COM) | |
| | | 3 | Remote controller disabling input | Enables / disables start / stop control via remote controller |
| | | 4 | In-operation output | ON during operation (HA answerback signal) |
| | | 5 | DC12 V (COM) | |
| | | 6 | Alarm output | ON while alarm ON |
| Optional output | CN60 | 1 | DC12 V (COM) | |
| | | 2 | Defrosting output | ON while outdoor unit defrosted |
| | | 3 | Thermostat ON output | ON while real thermostat ON (compressor ON) |
| | | 4 | Cooling output | ON while air conditioner in cooling or related operation (COOL, DRY or cooling under AUTO mode) |
| | | 5 | Heating output | ON while air conditioner in heating operation (HEAT or heating under AUTO mode) |
| | | 6 | Fan output | ON while indoor fan ON (via interlock wiring) |
| External error input | CN80 | 1 | DC12 V (COM) | Generates test code L30 and automatically shuts down air conditioner (only if condition persists for 1 minute) |
| | | 2 | DC12 V (COM) | |
| | | 3 | External error input | |
| CHK Operation check | CN71 | 1 | Check mode input | Used for indoor operation check (prescribed operational status output, such as indoor fan "H" or drain pump ON, to be generated without communication with outdoor unit or remote controller) |
| | | 2 | 0 V | |
| DISP Display mode | CN72 | 1 | Display mode input | Product display mode - Communication just between indoor unit and remote controller enabled (upon turning on of power) Timer short-circuited out (always) |
| | | 2 | 0 V | |
| EXCT Demand | CN73 | 1 | Demand input | Imposes thermostat OFF on indoor unit |
| | | 2 | 0 V | |

7. TROUBLESHOOTING

7-1. Summary of Troubleshooting

<Wired remote controller type>

1. Before troubleshooting

1) Required tools/instruments

- ⊕ and ⊖ screwdrivers, spanners, radio cutting pliers, nippers, push pins for reset switch
- Tester, thermometer, pressure gauge, etc.

2) Confirmation points before check

a) The following operations are normal.

1. Compressor does not operate.

- Is not 3-minutes delay (3 minutes after compressor OFF)?
- Is not the outdoor unit in standby status though the remote controller reached the setup temperature?
- Does not timer operate during fan operation?
- Is not an overflow error detected on the indoor unit?
- Is not outside high-temperature operation controlled in heating operation?

2. Indoor fan does not rotate.

- Does not cool air discharge preventive control work in heating operation?

3. Outdoor fan does not rotate or air volume changes.

- Does not high-temperature release operation control work in heating operation?
- Does not outside low-temperature operation control work in cooling operation?
- Is not defrost operation performed?

4. ON/OFF operation cannot be performed from remote controller.

- Is not the control operation performed from outside/remote side?
- Is not automatic address being set up?
(When the power is turned on at the first time or when indoor unit address setting is changed, the operation cannot be performed for maximum approx. 5 minutes after power-ON.)
- Is not being carried out a test run by operation of the outdoor controller?

b) Did you return the cabling to the initial positions?

c) Are connecting cables of indoor unit and remote controller correct?

2. Troubleshooting procedure

When a trouble occurred, check the parts along with the following procedure.



NOTE :

For cause of a trouble, power conditions or malfunction/erroneous diagnosis of microcomputer due to outer noise is considered except the items to be checked. If there is any noise source, change the cables of the remote controller to shield cables.

<Wireless remote controller type>

1. Before troubleshooting

- 1) Required tools/instruments
 - ⊕ and ⊖ screwdrivers, spanners, radio cutting pliers, nippers, etc.
 - Tester, thermometer, pressure gauge, etc.
- 2) Confirmation points before check
 - a) The following operations are normal.
 1. Compressor does not operate.
 - Is not 3-minutes delay (3 minutes after compressor OFF)?
 - Is not the outdoor unit in standby status though the remote controller reached the setup temperature?
 - Does not timer operate during fan operation?
 - Is not an overflow error detected on the indoor unit?
 - Is not outside high-temperature operation controlled in heating operation?
 2. Indoor fan does not rotate.
 - Does not cool air discharge preventive control work in heating operation?
- 3) Outdoor fan does not rotate or air volume changes.
 - Does not high-temperature release operation control work in heating operation?
 - Does not outside low-temperature operation control work in cooling operation?
 - Is not defrost operation performed?
- 4) ON/OFF operation cannot be performed from remote controller.
 - Is not forced operation performed?
 - Is not the control operation performed from outside/remote side?
 - Is not automatic address being set up?
 - Is not being carried out a test run by operation of the outdoor controller?
 - a) Did you return the cabling to the initial positions?
 - b) Are connecting cables between indoor unit and receiving unit correct?

2. Troubleshooting procedure

(When the power is turned on at the first time or when indoor unit address setting is changed, the operation cannot be performed for maximum approx. 5 minutes after power-ON.)

When a trouble occurred, check the parts along with the following procedure.



1) Outline of judgment

The primary judgment to check where a trouble occurred in indoor unit or outdoor unit is performed with the following method.

Method to judge the erroneous position by flashing indication on the display part of indoor unit (sensors of the receiving unit)

The indoor unit monitors operating status of the air conditioner, and the blocked contents of self-diagnosis are displayed restricted to the following cases if a protective circuit works.

7-2. Troubleshooting

7-2-1. Outline of judgment

The primary judgment to check whether a trouble occurred in the indoor unit or outdoor unit is carried out with the following method.



Method to judge the troubled position by flashing indication on the display part of the indoor unit (sensors of the receiving part)

The indoor unit monitors the operating status of the air conditioner, and the blocked contents of self-diagnosis are displayed restricted to the following cases if a protective circuit works.

● : Go off, ○ : Go on, ◐ : Flash (0.5 sec.)

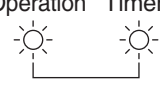
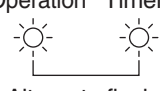
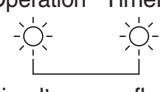
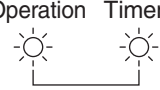

| Lamp indication | Check code | Cause of trouble occurrence |
|--|---|--|
| Operation Timer Ready ● ● ● No indication at all | — | Power supply OFF or miswiring between receiving unit and indoor unit |
| Operation Timer Ready ◐ ● ● Flash | E01 | Receiving trouble } Receiving unit } Sending trouble } } Miswiring or wire connection trouble Communication stop } } between receiving unit and indoor unit |
| | E02 | |
| | E03 | |
| | E08 | Duplicated indoor unit No. Duplicated header units of remote controller } Setup trouble |
| | | |
| | | E11 |
| E18 | Wire connection trouble between indoor units, Indoor power OFF (Communication stop between indoor header and follower or between master and sub indoor twin) | |
| Operation Timer Ready ● ● ◐ Flash | E04 | Miswiring between indoor unit and outdoor unit or connection trouble (Communication stop between indoor and outdoor units) |
| Operation Timer Ready ● ◐ ◐ Alternate flash | P10 | Overflow was detected. } Indoor DC fan trouble } Protective device of indoor unit worked. |
| | P12 | |
| Operation Timer Ready ◐ ● ◐ Alternate flash | P03 | Outdoor unit discharge temp. trouble } Protective device of } Outdoor high pressure system trouble } outdoor unit worked. *1 |
| | P04 | |
| | P05 | Negative phase detection trouble } Heat sink overheat trouble } Outdoor unit trouble Gas leak detection trouble } |
| | P07 | |
| | P15 | |
| | P19 | 4-way valve system trouble (Indoor or outdoor unit judged.) |
| | P20 | Outdoor unit high pressure protection |
| | P22 | Outdoor unit: Outdoor unit trouble } Outdoor unit: Inverter Idc operation } Protective device of } Outdoor unit: Position detection trouble } outdoor unit worked. *1 |
| | P26 | |
| P29 | | |
| P31 | Stopped because of trouble of other indoor unit in a group (Check codes of E03/L03/L07/L08) | |

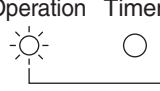
*1: These are representative examples and the check code differs according to the outdoor unit to be combined.

| Lamp indication | Check code | Cause of trouble occurrence |
|--|------------|--|
| Operation Timer Ready  Alternate flash | F01 | Heat exchanger sensor (TCJ) trouble Heat exchanger sensor (TC) trouble Room air temperature sensor (TA) trouble } Indoor unit sensor trouble |
| | F02 | |
| | F10 | |
| Operation Timer Ready  Alternate flash | F04 | Discharge temp. sensor (TD) trouble Temp. sensor (TE) trouble Temp. sensor (TL) trouble Temp. sensor (TO) trouble Temp. sensor (TS) trouble Temp. sensor (TH) trouble Temp. Sensor miswiring (TE, TS) } Sensor trouble of outdoor unit *1 |
| | F06 | |
| | F07 | |
| | F08 | |
| | F12 | |
| | F13 | |
| | F15 | |
| Operation Timer Ready  Simultaneous flash | F29 | Indoor EEPROM trouble |
| Operation Timer Ready  Simultaneous flash | F31 | Outdoor EEPROM trouble |
| Operation Timer Ready  Flash | H01 | Compressor break down Compressor lock Current detection circuit trouble Case thermostat worked. Outdoor unit low pressure system trouble } Outdoor compressor system trouble *1 |
| | H02 | |
| | H03 | |
| | H04 | |
| | H06 | |
| Operation Timer Ready  Simultaneous flash | L03 | Duplicated header indoor units There is indoor unit of group connection in individual indoor unit. Unsetting of group address Missed setting (Unset indoor capacity) } → AUTO address * If group construction and address are not normal when power supply turned on, automatically goes to address setup mode. |
| | L07 | |
| | L08 | |
| | L09 | |
| Operation Timer Ready  Simultaneous flash | L10 | Unset model type (Service board) Duplicated indoor central addresses Outdoor unit and other trouble Outside interlock trouble Negative phase trouble } Others |
| | L20 | |
| | L29 | |
| | L30 | |
| | L31 | |

*1: These are representative examples and the check code differs according to the outdoor unit to be combined.

7-2-2. Others (Other than Check Code)

| Lamp indication | Check code | Cause of trouble occurrence |
|--|------------|---|
| Operation Timer Ready  Simultaneous flash | — | During test run |
| Operation Timer Ready  Alternate flash | — | Disagreement of cool/heat (Automatic cool/heat setting to automatic cool/heat prohibited model, or setting of heating to cooling-only model) |

7-2-3. Check Code List (Indoor)

(Indoor unit detected)

○ : Go on, ◎ : Flash, ● : Go off ALT (Alternate): Alternate flashing when there are two flashing LED SIM (Simultaneous): Simultaneous flashing when there are two flashing LED

| Check code indication Central control device & Wired remote controller | Lamp indication Block indication | | | Representative trouble position | Explanation of trouble contents | Air conditioner operation | |
|--|-------------------------------------|-------|-------|--|---|---------------------------|---------------------------|
| | Operation | Timer | Ready | | | Automatic reset | Operation continuation |
| E03 | ◎ | ● | ● | Regular communication trouble between indoor and remote controller | No communication from remote controller and network adapter (Also no communication from central control system) | ✓ | — |
| E04 | ● | ● | ◎ | Indoor/Outdoor serial trouble | There is trouble on serial communication between indoor and outdoor units | ✓ | — |
| E08 | ◎ | ● | ● | Duplicated indoor addresses | Same address as yours was detected. | ✓ | — |
| E11 | ◎ | ● | ● | Communication trouble between Application control kit and indoor unit | Communication trouble between Application control kit and indoor unit P.C. board | ✓ | — |
| E18 | ◎ | ● | ● | Regular communication trouble between indoor header and follower units | Regular communication between twin header (master) and follower (sub) units is impossible. Communication between twin header (master) and follower (sub) units is impossible. | ✓ | — |
| F01 | ◎ | ◎ | ● | Indoor unit, Heat exchanger (TC.) trouble | Open/short-circuit was detected on heat exchanger (TC.). | ✓ | — |
| F02 | ◎ | ◎ | ● | Indoor unit, Heat exchanger (TC) trouble | Open/short-circuit was detected on heat exchanger (TC). | ✓ | — |
| F10 | ◎ | ◎ | ● | Indoor unit, Room temp. sensor (TA) trouble | Open/short-circuit was detected on room temp. sensor (TA). | ✓ | — |
| F29 | ◎ | ◎ | ● | Indoor unit, other indoor PC. board trouble | EEPROM trouble (Other trouble may be detected. If no trouble, automatic address is repeated.) | — | — |
| L03 | ◎ | ◎ | ◎ | Duplicated setting of indoor group header unit | There are multiple header units in a group. | — | — |
| L07 | ◎ | ● | ◎ | There are group cable in individual indoor unit. | When even one group connection indoor unit exists in individual indoor unit. | — | — |
| L08 | ◎ | ◎ | ◎ | Unset indoor group address | Indoor group address is unset. | — | — |
| L09 | ◎ | ● | ◎ | Unset indoor capacity | Capacity of indoor unit is unset. | — | — |
| L20 | ◎ | ○ | ◎ | Duplicated central control system address | Duplicated setting of central control system address | ✓ | — |
| L30 | ◎ | ○ | ◎ | Outside trouble input to indoor unit (Interlock) | Abnormal stop by outside trouble CN80/TB2 (IN1) input | — | — |
| P01 | ● | ◎ | ◎ | Indoor unit, AC fan trouble | An trouble of indoor AC fan was detected. (Fan motor thermal relay worked.) | — | — |
| P10 | ● | ◎ | ◎ | Indoor unit, overflow detection | Floater switch worked. | — | — |
| P12 | ● | ◎ | ◎ | Indoor unit, DC fan trouble | Indoor DC fan trouble (Over-current/Lock, etc.) was detected. | — | — |
| P19 | ◎ | ◎ | ◎ | 4-way valve system trouble | In heating operation, a trouble was detected by temp. down of indoor heat exchanger sensor. | ✓ | — |
| P31 | ◎ | ● | ◎ | Other indoor unit trouble | Follower unit in group cannot operate by warning from [E03/L03/L07/L08] of header unit. | ✓ | — |

◇ When this warning was detected before group construction/address check finish at power supply was turned on, the mode shifts automatically to AUTO address setup mode.

(Remote controller detected)

| Check code indication Wired remote controller | Lamp indication Block indication | | | Representative trouble position | Explanation of trouble contents | Air conditioner operation | |
|--|-------------------------------------|-------|-------|--|--|---------------------------|---------------------------|
| | Operation | Timer | Ready | | | Automatic reset | Operation continuation |
| E01 | ◎ | ● | ● | No master remote controller. Remote controller communication (Receive) trouble | Signal cannot be received from indoor unit. Master remote controller was not set. (Including 2 remote controllers) | — | — |
| E02 | ◎ | ● | ● | Remote controller communication (Send) trouble | Signal cannot be sent to indoor unit. | — | — |
| E09 | ◎ | ● | ● | Duplicated master remote controller | In 2-remote controller control, both were set as master. (Indoor master unit stops warning and follower unit continues operation.) | — | △ |

△ : It is based on a situation.

(Central control devices detected)

| Check code indication Central control device | Lamp indication Block indication | | | Representative trouble position | Explanation of trouble contents | Air conditioner operation | |
|---|--|-------|-------|--|---|---------------------------|---------------------------|
| | Operation | Timer | Ready | | | Automatic reset | Operation continuation |
| C05 | Is not displayed. (Common use of wired remote controller, etc.) | | | Central control system communication (send) trouble | Signal sending operation of central control system is impossible. There are multiple same central devices. (Link adapter) | — | — |
| C06 | | | | Central control system communication (receive) trouble | Signal receiving operation of central control system is impossible. | — | — |
| C12 | — | | | General-purpose device control interface batched warning | An trouble on device connected to general-purpose device control interface of exclusive to Link adapter | — | — |
| P30 | By warning unit (Above-mentioned) | | | Group follower unit is trouble. | Group follower unit is trouble. (For remote controller, above-mentioned [***] details are displayed with unit No. | — | — |

NOTE: Even for the same contents of trouble such as communication trouble, the display of check code may differ according to detection device.
When wired remote controller or central controller detects an trouble, it is not necessarily related to operation of the air conditioner. In this list, the check codes that outdoor unit detects are not described.

Trouble mode detected by indoor unit

| Operation of diagnostic function | | | | Judgment and measures |
|----------------------------------|--|--|------------------------------------|---|
| Check code | Cause of operation | Status of air conditioner | Condition | |
| E03 | No communication from remote controller (including wireless) and communication adapter | Stop (Automatic reset) | Displayed when trouble is detected | 1. Check cables of remote controller and communication adapters. • Remote controller LCD display OFF (Disconnection) • Central remote controller [97] check code |
| E04 | The serial signal is not output from outdoor unit to indoor unit. • Miswiring of inter-unit wire • Serial communication circuit trouble of outdoor P.C. board • Serial communication circuit trouble of indoor P.C. board | Stop (Automatic reset) | Displayed when trouble is detected | 1. Outdoor unit does not completely operate. • Inter-unit wire check, correction of miswiring • Check outdoor P.C. board. Correct wiring of P.C. board. 2. When outdoor unit normally operates • Check P.C. board (Indoor receiving / Outdoor sending). |
| E08 | Duplicated indoor unit address | Stop | Displayed when trouble is detected | 1. Check whether remote controller connection (Group/Individual) was changed or not after power supply turned on (Finish of group construction/Address check). * If group construction and address are not normal when the power has been turned on, the mode automatically shifts to address setup mode. (Resetting of address) |
| L03 | Duplicated indoor header unit | | | |
| L07 | There is group wire in individual indoor unit. | | | |
| L08 | Unset indoor group address | | | |
| L09 | Unset indoor capacity | Stop | Displayed when trouble is detected | 1. Set indoor capacity (DN=11) |
| L30 | Abnormal input of outside interlock | Stop | Displayed when trouble is detected | 1. Check outside devices. 2. Check indoor P.C. board. |
| P10 | Float switch operation • Float circuit, Disconnection, Coming-off, Float switch contact trouble | Stop | Displayed when trouble is detected | 1. Trouble of drain pump 2. Clogging of drain pump 3. Check float switch. 4. Check Application control kit (TCB-PCUC2E) |
| P12 | Indoor DC fan trouble | Stop | Displayed when trouble is detected | 1. Position detection trouble 2. Check fan motor (Protective circuit operation). 3. Indoor fan locked. 4. Check indoor P.C. board. |
| P19 | 4-way valve system trouble • After heating operation has started, indoor heat exchangers temp. is down. | Stop (Automatic reset) | Displayed when trouble is detected | 1. Check 4-way valve. 2. Check 2-way valve and check valve. 3. Check indoor heat exchanger (TC/TCJ). 4. Check indoor P.C. board. |
| P31 | Unit automatically stops while warning is output to other indoor units. | Stop (Follower unit) (Automatic reset) | Displayed when trouble is detected | 1. Judge follower unit while header unit is [E03], [L03], [L07] or [L08]. 2. Check indoor P.C. board. |
| F01 | Coming-off, disconnection or short-circuit of indoor heat exchanger temp. sensor (TCJ) | Stop (Automatic reset) | Displayed when trouble is detected | 1. Check indoor heat exchanger temp. sensor (TCJ). 2. Check indoor P.C. board. |
| F02 | Coming-off, disconnection or short-circuit of indoor heat exchanger temp. sensor (TC) | Stop (Automatic reset) | Displayed when trouble is detected | 1. Check indoor heat exchanger temp. sensor (TC). 2. Check indoor P.C. board. |
| F10 | Coming-off, disconnection or short-circuit of indoor room air temp. sensor (TA) | Stop (Automatic reset) | Displayed when trouble is detected | 1. Check indoor room air temp. sensor (TA). 2. Check indoor P.C. board. |
| F29 | Indoor EEPROM trouble • EEPROM access trouble | Stop (Automatic reset) | Displayed when trouble is detected | 1. Check indoor EEPROM. (including socket insertion) 2. Check indoor P.C. board. |
| E11 | Communication trouble between Application control kit and indoor unit | Stop (Automatic reset) | Displayed when trouble is detected | 1. Check power supply/communication harness. 2. Check indoor P.C. board. |
| E18 | Regular communication trouble between indoor header and follower units and between master and sub units | Stop (Automatic reset) | Displayed when trouble is detected | 1. Check remote controller wiring. 2. Check indoor power supply wiring. 3. Check indoor P.C. board. |

Trouble mode detected by remote controller or central controller (Link adapter)

| Operation of diagnostic function | | | | Judgment and measures |
|---|---|---|------------------------------------|--|
| Check code | Cause of operation | Status of air conditioner | Condition | |
| Not displayed at all (Operation on remote controller is impossible.) | No communication with header indoor unit <ul style="list-style-type: none"> Remote controller wiring is not correct. Power of indoor unit is not turned on. Automatic address cannot be completed. | Stop | — | Power supply trouble of remote controller, Indoor EEPROM trouble <ol style="list-style-type: none"> Check remote controller inter-unit wiring. Check remote controller. Check indoor power wiring. Check indoor P.C. board. Check indoor EEPROM. (including socket insertion) Automatic address repeating phenomenon generates. |
| E01 *1 | No communication with header indoor unit <ul style="list-style-type: none"> Disconnection of inter-unit wire between remote controller and header indoor unit (Detected by remote controller side) | Stop (Automatic reset) * If central controller exists, operation continues. | Displayed when trouble is detected | Receiving trouble from remote controller <ol style="list-style-type: none"> Check remote controller inter-unit wiring. Check remote controller. Check indoor power wiring. Check indoor P.C. board. |
| E02 | Signal send trouble to indoor unit (Detected by remote controller side) | Stop (Automatic reset) * If central controller exists, operation continues. | Displayed when trouble is detected | Sending trouble of remote controller <ol style="list-style-type: none"> Check sending circuit inside of remote controller. → Replace remote controller. |
| E09 | There are multiple master remote controllers. (Detected by remote controller side) | Stop (Follower unit continues operation.) | Displayed when trouble is detected | <ol style="list-style-type: none"> In 2-remote controllers (including wireless), there are multiple header units. Check that there are 1 master remote controller and other sub remote controllers. |
| L20 ----- Central controller L20 | Duplicated indoor central addresses on communication of central control system (Detected by indoor/central controller side) | Stop (Automatic reset) | Displayed when trouble is detected | <ol style="list-style-type: none"> Check setting of central control system network address. (Network adapter SW01) Check network adapter P.C. board. |
| — *2 ----- Central controller (Send) C05 (Receive) C06 | Communication circuit trouble of central controller (Detected by central controller side) | Continues (By remote controller) | Displayed when trouble is detected | <ol style="list-style-type: none"> Check communication wire / miswiring Check communication (Uh (U3,U4) terminals) Check network adapter P.C. board. Check central controller (such as central control remote controller, etc.) Check terminal resistance. ("1 : 1 Model" Connection Interface P.C. board or indoor P.C. board) |
| — ----- Central controller P30 | Indoor Gr sub unit trouble (Detected by central controller side) | Continuation/Stop (According to each case) | Displayed when trouble is detected | Check the check code of the corresponding unit from remote controller. |

*1 The check code cannot be displayed by the wired remote controller.

(Usual operation of air conditioner becomes unavailable.)

For the wireless models, a trouble is notified with indication lamp.

*2 This trouble is related to communication of remote controller (A, B), central system (Uh (U3,U4)), and [E01], [E02], [E03], [E09] or [E18] is displayed or no check display on the wired remote controller according to the contents.

7-2-4. Diagnostic Procedure for Each Check Code (Indoor Unit)

Check code

[E01 trouble]

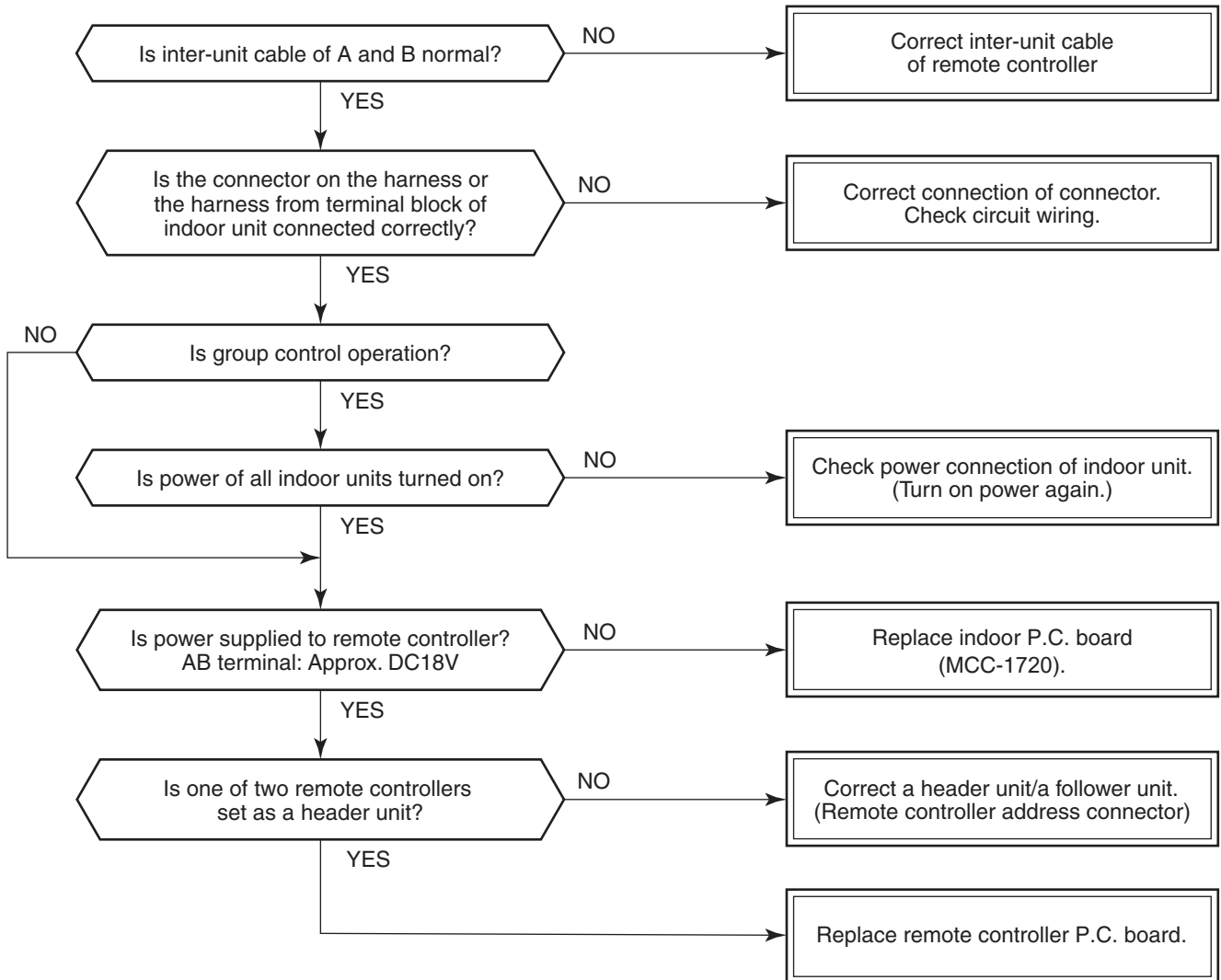

[E09 trouble]

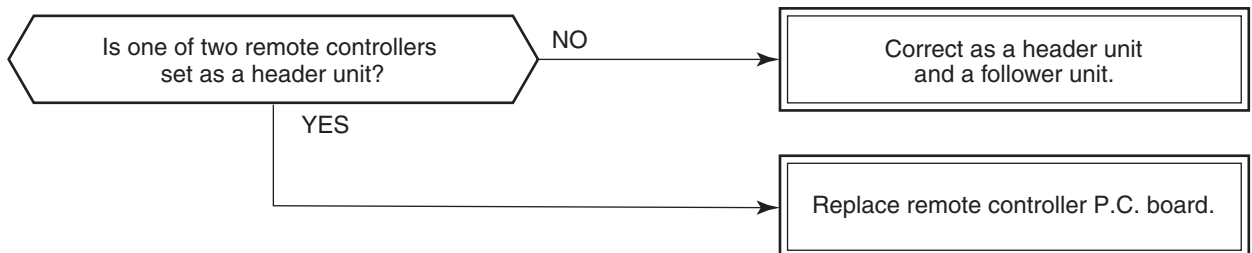

[E04 trouble]

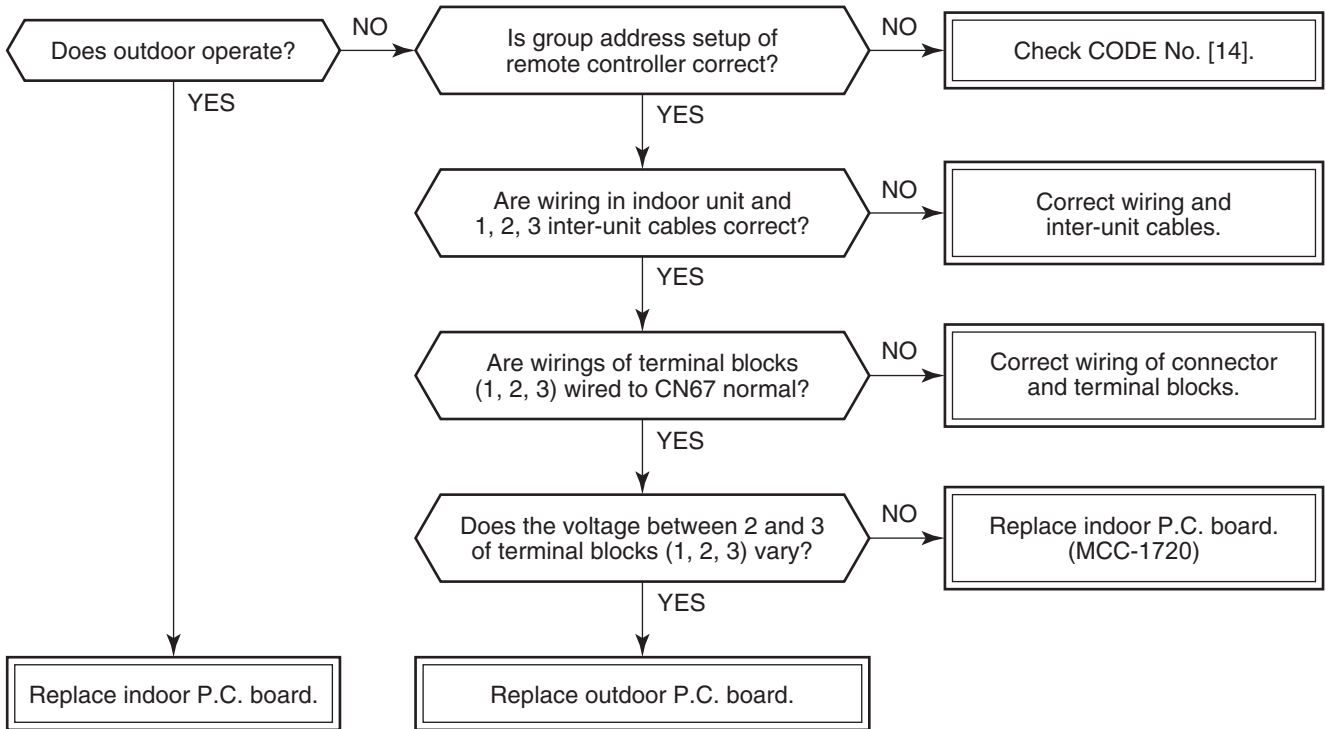

As shown in the following figure, carry out measurement within 20 seconds after the power was turned on.

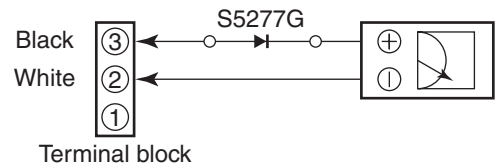

[E11 trouble]

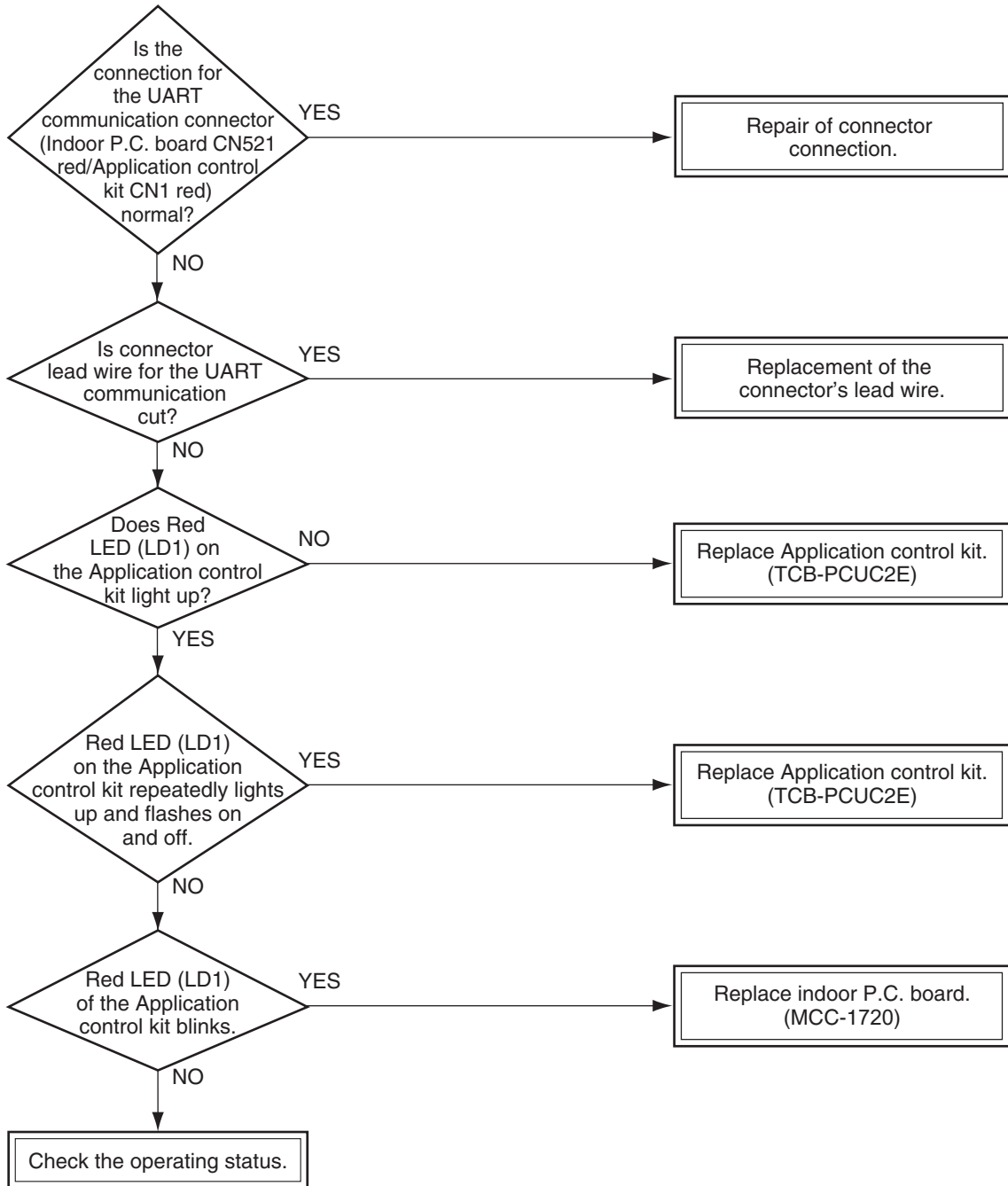

[E18 trouble]

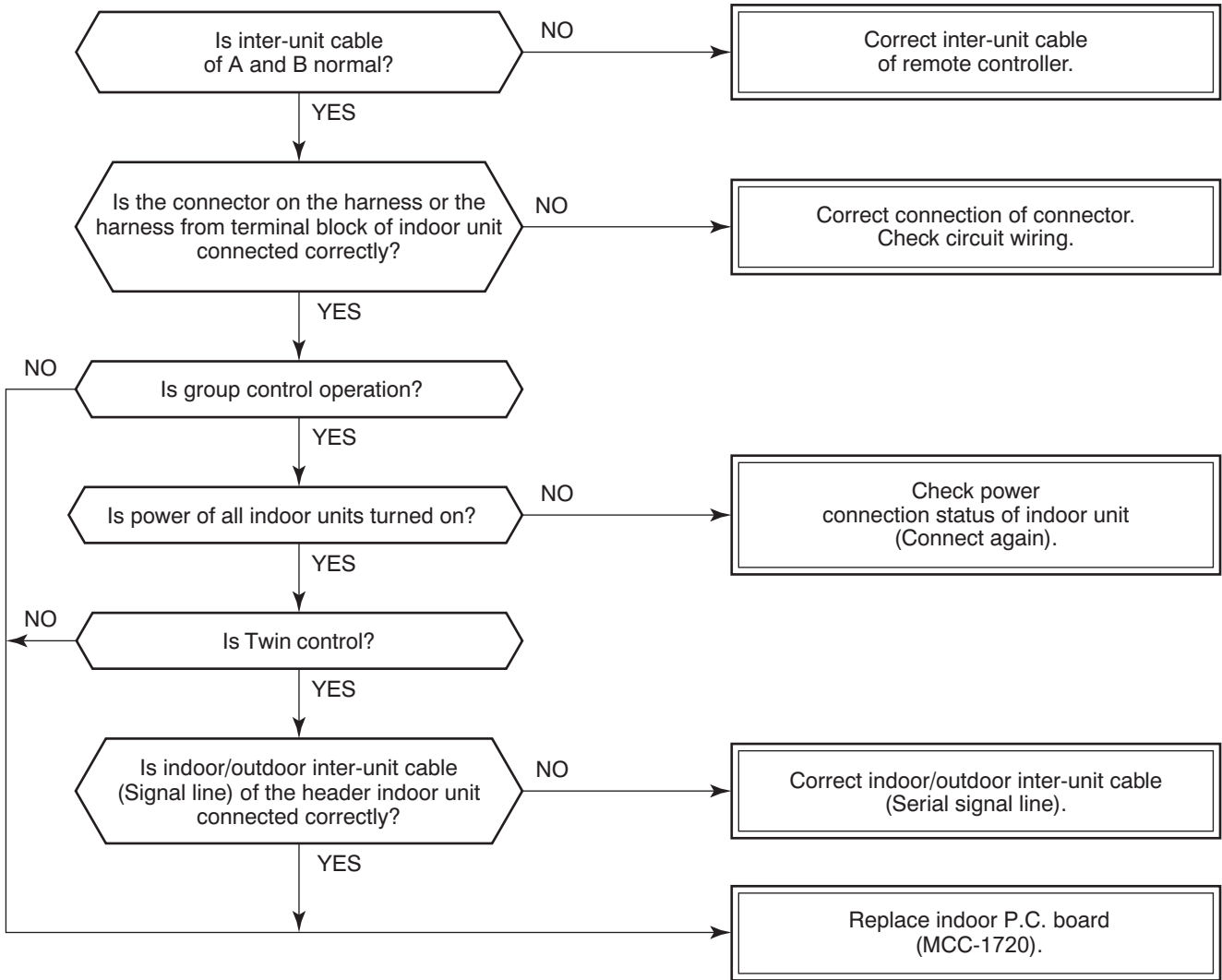

[E08, L03, L07, L08 trouble]

E08: Duplicated indoor unit No.

L03: There are 2 or more header units in a group control.

L07: There is 1 or more group address [Individual] in a group control.

L08: The indoor group address is unset. (CODE NO. (DN) [14] = 00Un or 0099)

If the above trouble is detected when power supply turned on, the mode enters automatically in the automatic address set mode. (Check code is not output.)

However, if the above trouble is detected during the automatic address set mode, a check code may be output.

[L09 trouble]

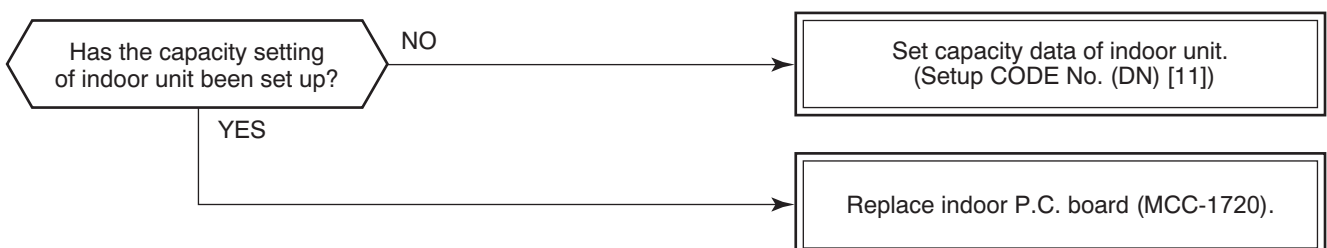

[L20 trouble]

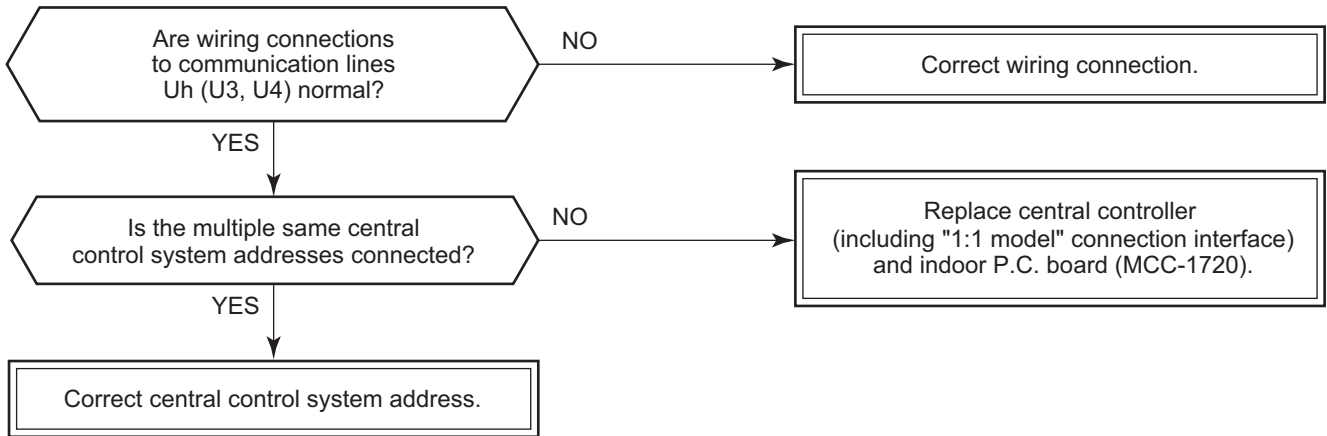

[L30 trouble]

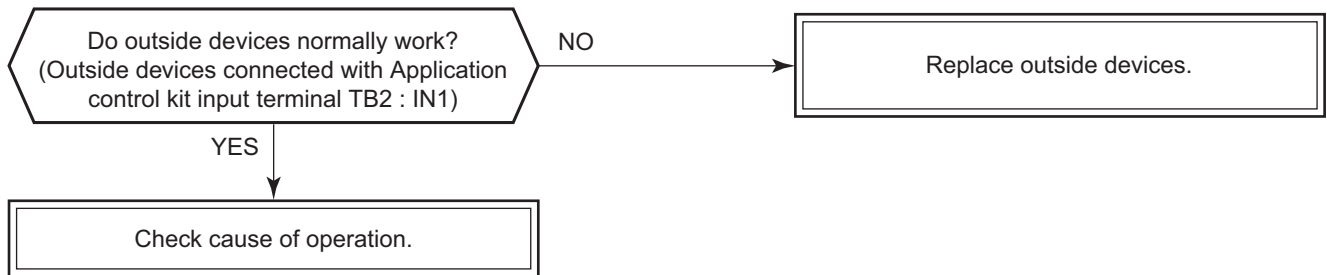

[P30 trouble] (Central controller)

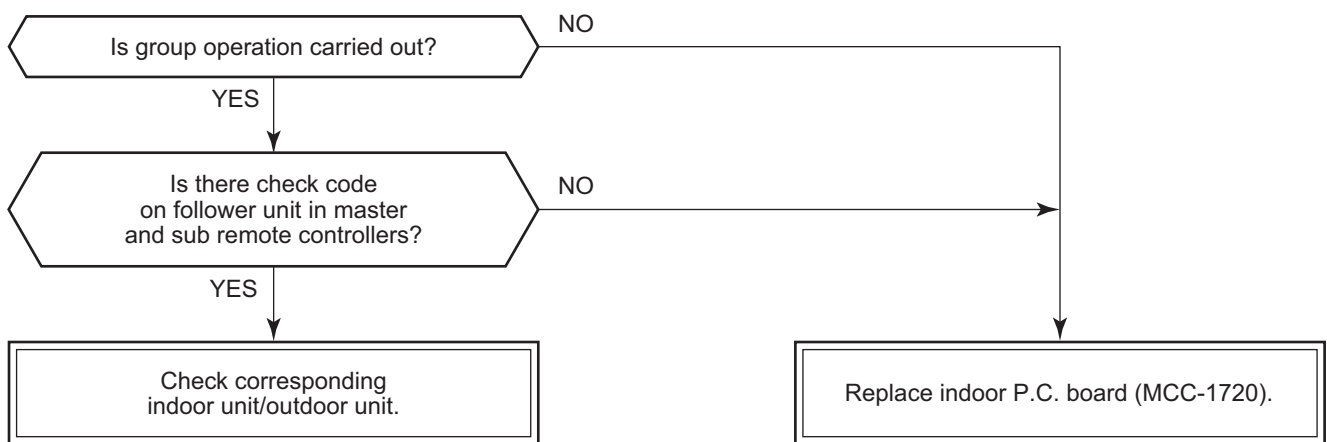

[P10 trouble]

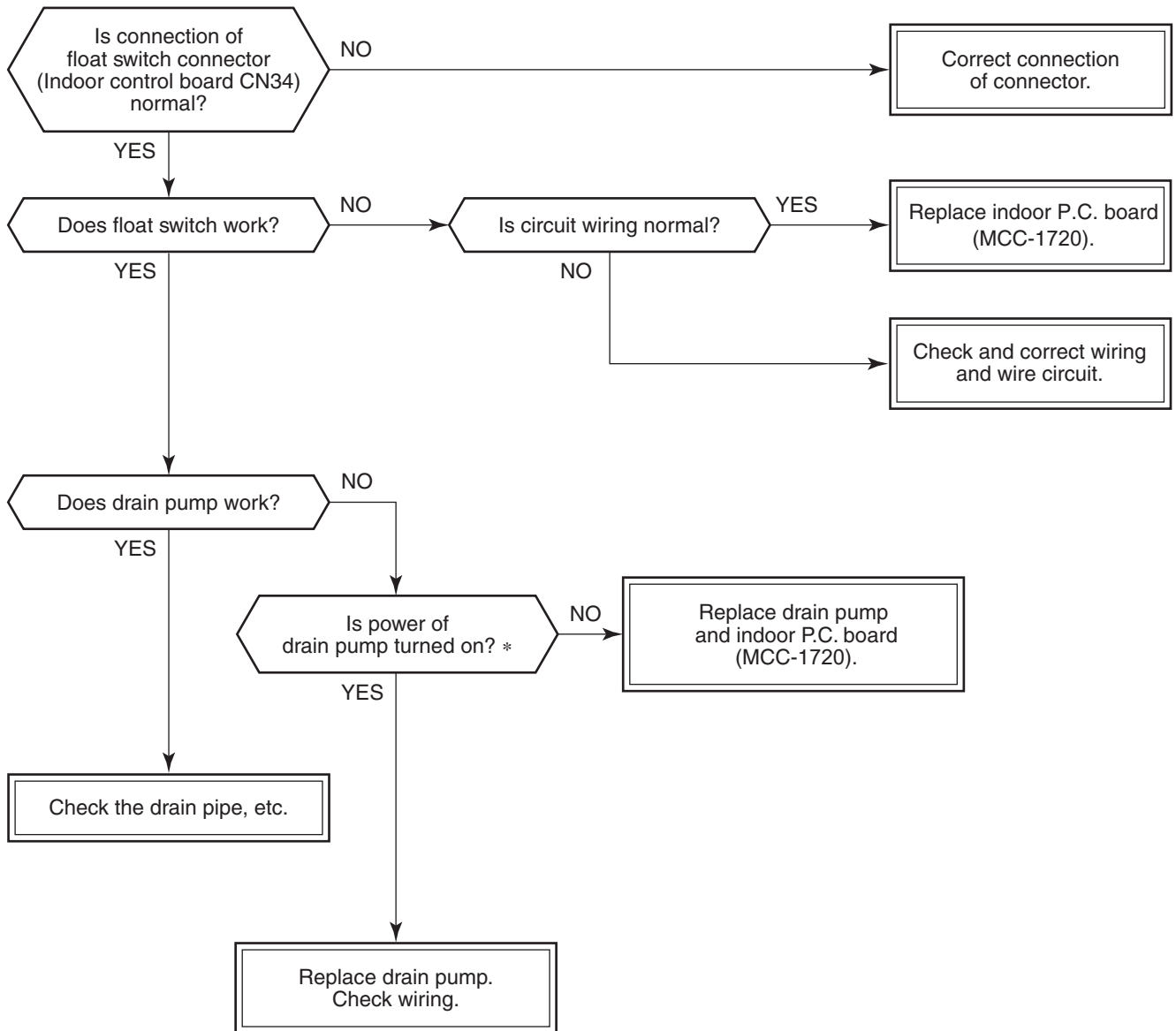

* Check that voltage of 1-2 pin of CN504 on the indoor P.C. board is +12V. (1 pin is plus (+).)

[F10 trouble]

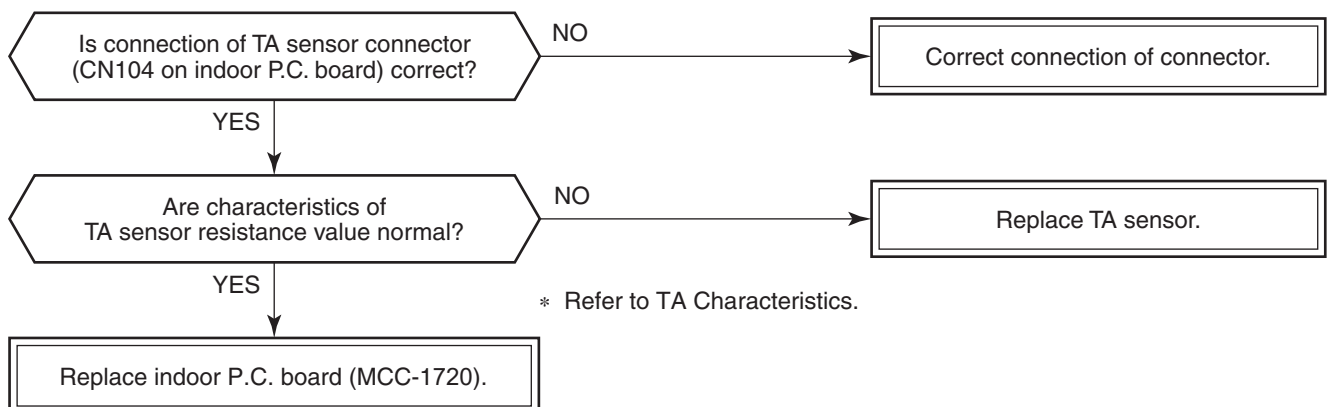

[P12 error]

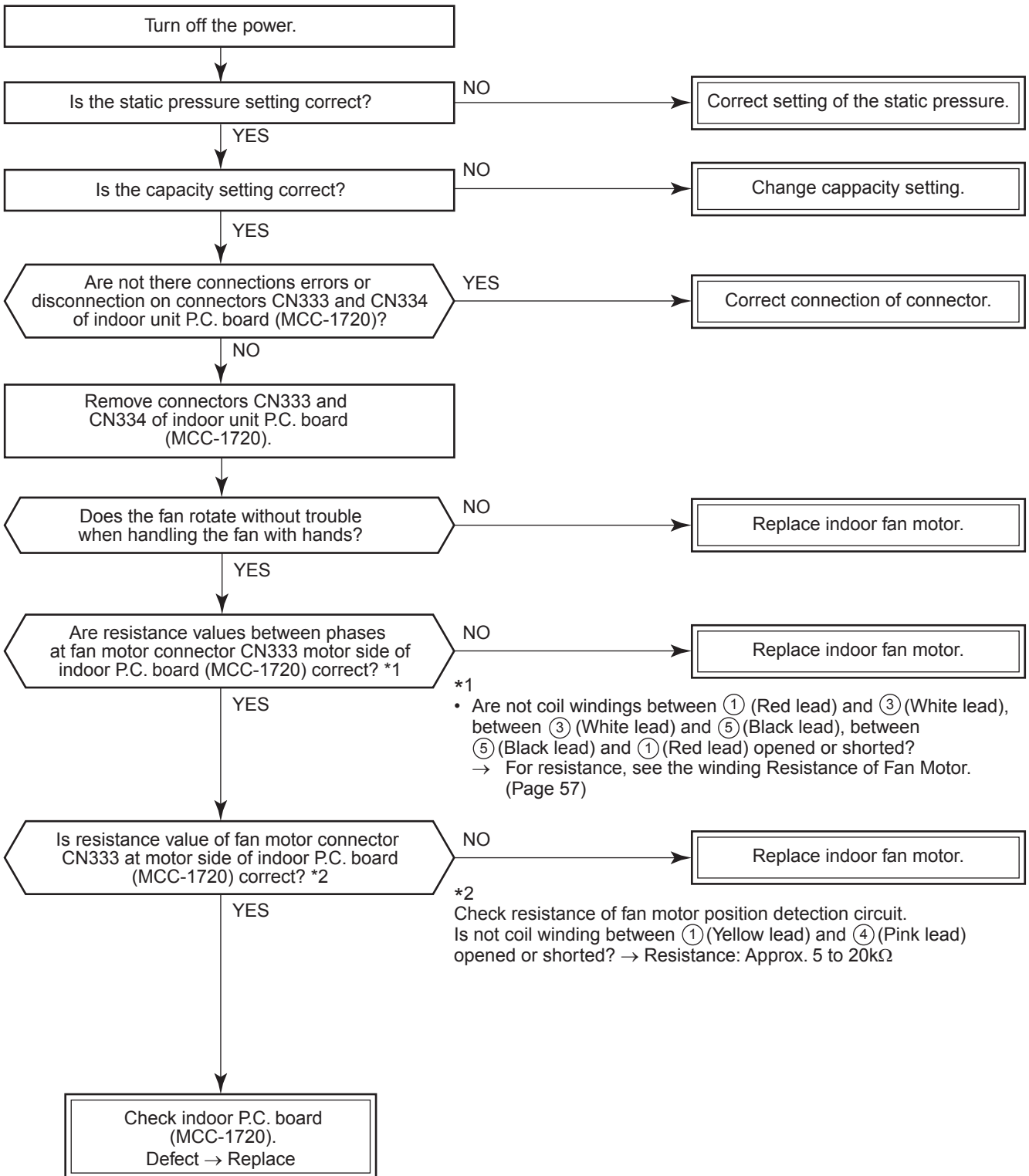

[P19 trouble]

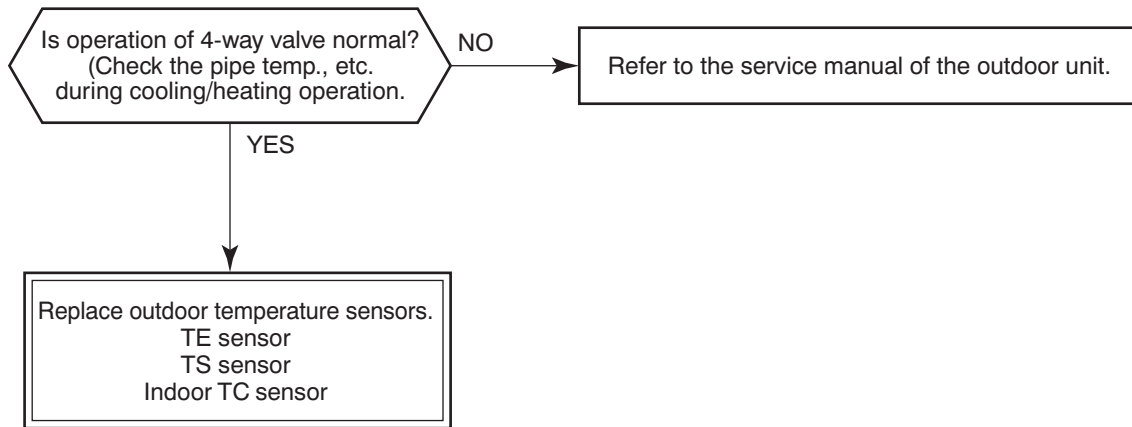

[F02 trouble]

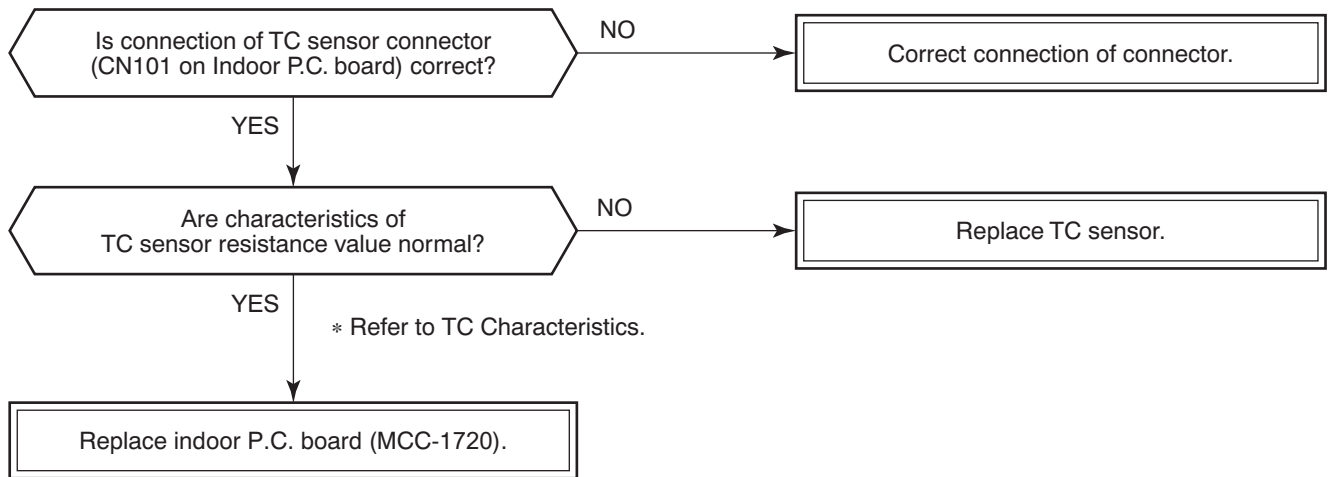

[F01 trouble]

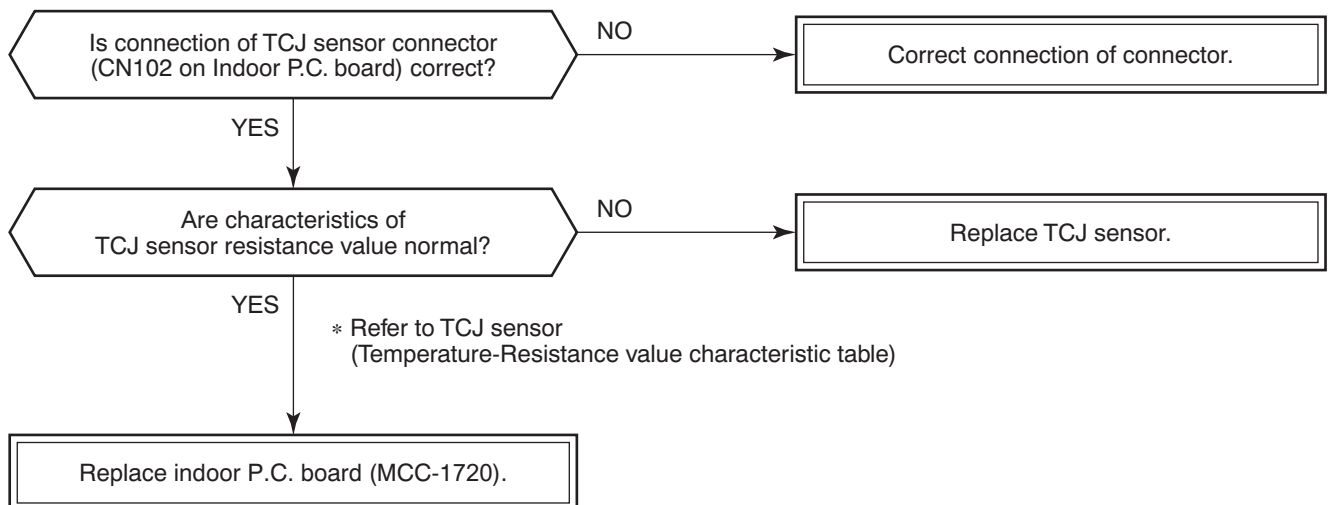

[C06 trouble] (“1:1 model” connection interface)

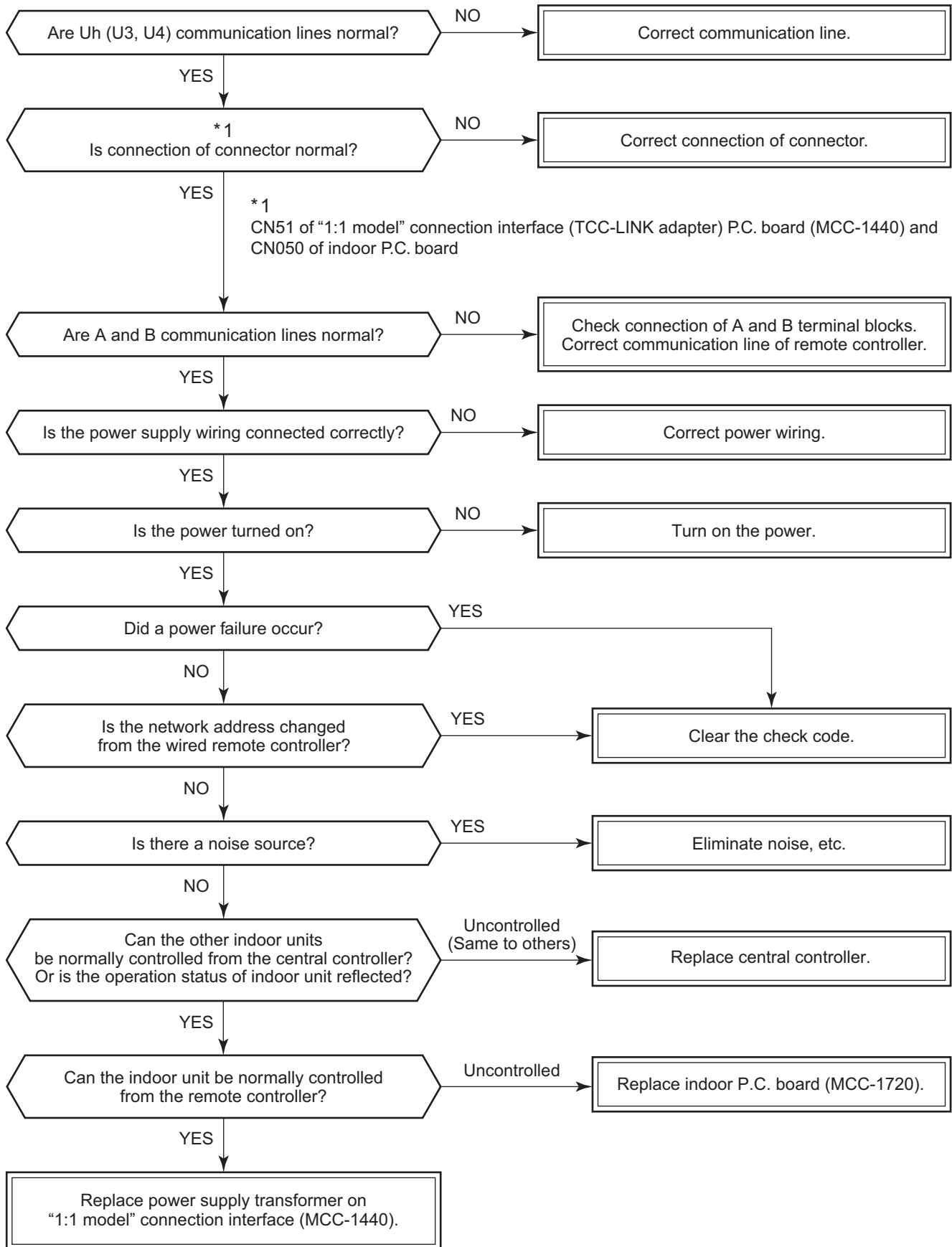

[E03 trouble] (Header indoor unit)

[E03 trouble] is detected when the indoor unit cannot receive a signal from the remote controller (also central controller).

Check A and B remote controllers and communication lines of the central control system Uh (U3, U4).

As communication is impossible, this check code [E03] is not displayed on the remote controller and the central controller. [E01] is displayed on the remote controller and [C06 trouble] is displayed on the central controller.

If these check codes generate during operation, the air conditioner stops.

[F29 trouble]

This check code indicates a detection trouble of IC503 non-volatile memory (EEPROM) on the indoor unit P.C. board, which generated during operation of the air conditioner. Replace the service P.C. board.

* When EEPROM was not inserted when power supply turned on or when the EEPROM data read/write operation is impossible at all, the automatic address mode is repeated. In this time, [C06 trouble] is displayed on the central controller.

[P31 trouble] (Follower indoor unit)

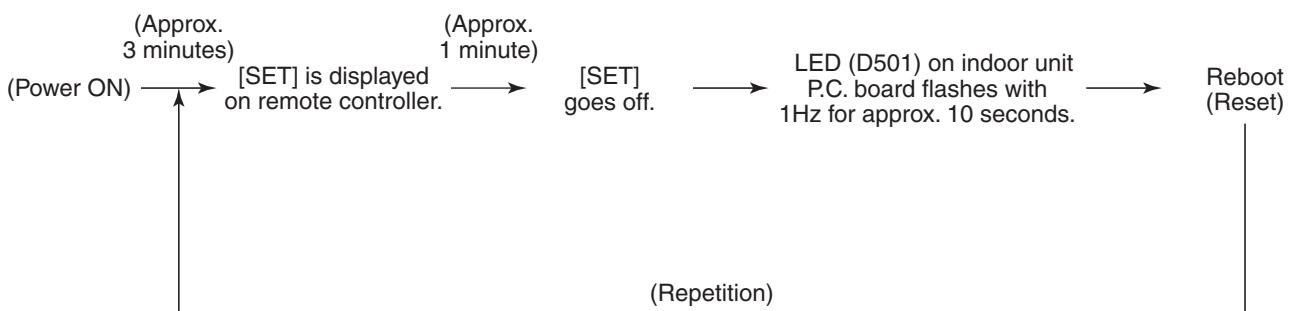

When the header unit of a group operation detected [E03], [L03], [L07] or [L08] trouble, the follower unit of the group operation detects [P31 trouble] and then the unit stops.

There is no display of the check code or alarm history of the wired remote controller. (In this model, the mode enters in automatic address set mode when the header unit detected [L03], [L07] or [L08] trouble.)

Temperature – Resistance value characteristic table

TA, TC, TCJ, TE, TS, TO sensor

Representative value

| Temperature (°C) | Resistance value (kΩ) | | |
|------------------|-----------------------|------------------|-----------------|
| | (Minimum value) | (Standard value) | (Maximum value) |
| 0 | 32.33 | 33.80 | 35.30 |
| 10 | 19.63 | 20.35 | 21.09 |
| 20 | 12.23 | 12.59 | 12.95 |
| 25 | 9.75 | 10.00 | 10.25 |
| 30 | 7.764 | 7.990 | 8.218 |
| 40 | 5.013 | 5.192 | 5.375 |
| 50 | 3.312 | 3.451 | 3.594 |
| 60 | 2.236 | 2.343 | 2.454 |
| 70 | 1.540 | 1.623 | 1.709 |
| 80 | 1.082 | 1.146 | 1.213 |
| 90 | 0.7740 | 0.8237 | 0.8761 |
| 100 | 0.5634 | 0.6023 | 0.6434 |

TD, TL sensor

Representative value

| Temperature (°C) | Resistance value (kΩ) | | |
|------------------|-----------------------|------------------|-----------------|
| | (Minimum value) | (Standard value) | (Maximum value) |
| 0 | 150.5 | 161.3 | 172.7 |
| 10 | 92.76 | 99.05 | 105.6 |
| 20 | 58.61 | 62.36 | 66.26 |
| 25 | 47.01 | 49.93 | 52.97 |
| 30 | 37.93 | 40.22 | 42.59 |
| 40 | 25.12 | 26.55 | 28.03 |
| 50 | 17.00 | 17.92 | 18.86 |
| 60 | 11.74 | 12.34 | 12.95 |
| 70 | 8.269 | 8.668 | 9.074 |
| 80 | 5.925 | 6.195 | 6.470 |
| 90 | 4.321 | 4.507 | 4.696 |
| 100 | 3.205 | 3.336 | 3.468 |

TA, TC, TCJ, TE, TS, TO sensor

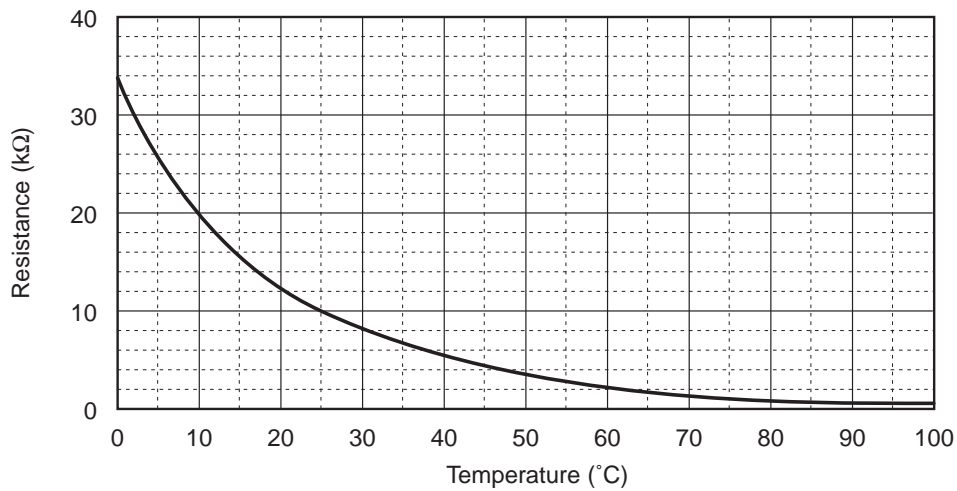

TD, TL sensor

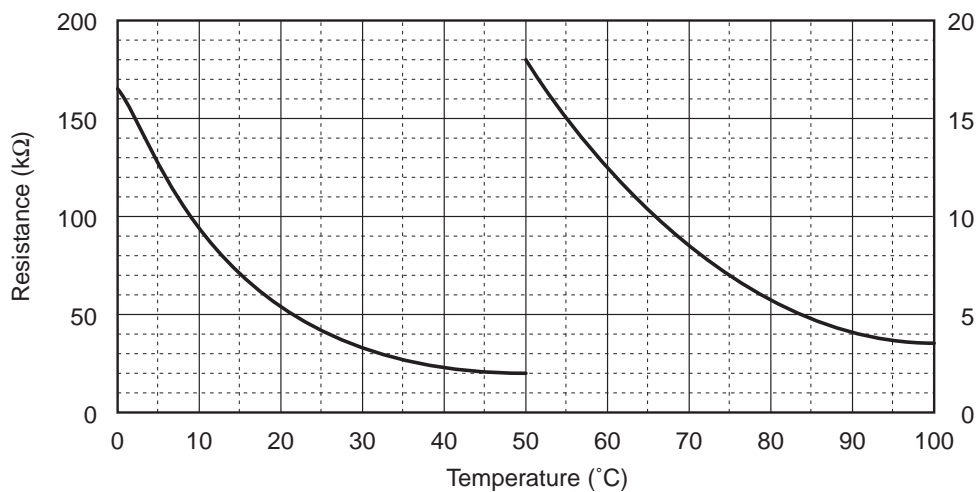

Winding Resistance of Fan Motor

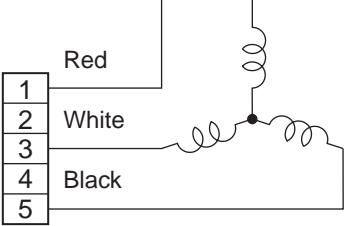
| Part name | Checking procedure | | | | | | | | | | | | | | | | |
|--|---|----------|------------------|-------------|------------|---------------|------------|-------------|------------|----------|------------------|-------------|------------|---------------|------------|-------------|------------|
| <p>Concealed Duct type Fan motor</p> <p>(ICF-340W150-2) RAV-HM561BTP*</p> <p>(ICF-340W150-1) RAV-HM801BTP*</p> <p>(ICF-340W250-1) RAV-RM901BTP* RAV-RM1101BTP* RAV-RM1401BTP* RAV-RM1601BTP*</p> | <p>Measure the resistance value of each winding by using the tester.</p> <p style="text-align: right;">ICF-340W150-1, 2</p> <table border="1" data-bbox="874 405 1406 607"> <thead> <tr> <th>Position</th> <th>Resistance value</th> </tr> </thead> <tbody> <tr> <td>Black – Red</td> <td>14.8 ± 1.5</td> </tr> <tr> <td>Black – White</td> <td>14.8 ± 1.5</td> </tr> <tr> <td>Red – White</td> <td>14.8 ± 1.5</td> </tr> </tbody> </table> <p style="text-align: right;">ICF-340W250-1</p> <table border="1" data-bbox="874 674 1406 875"> <thead> <tr> <th>Position</th> <th>Resistance value</th> </tr> </thead> <tbody> <tr> <td>Black – Red</td> <td>12.4 ± 1.2</td> </tr> <tr> <td>Black – White</td> <td>12.4 ± 1.2</td> </tr> <tr> <td>Red – White</td> <td>12.4 ± 1.2</td> </tr> </tbody> </table> <p style="text-align: right;">Under 20°C</p> <p>Fan motor inside wiring diagram</p>  | Position | Resistance value | Black – Red | 14.8 ± 1.5 | Black – White | 14.8 ± 1.5 | Red – White | 14.8 ± 1.5 | Position | Resistance value | Black – Red | 12.4 ± 1.2 | Black – White | 12.4 ± 1.2 | Red – White | 12.4 ± 1.2 |
| Position | Resistance value | | | | | | | | | | | | | | | | |
| Black – Red | 14.8 ± 1.5 | | | | | | | | | | | | | | | | |
| Black – White | 14.8 ± 1.5 | | | | | | | | | | | | | | | | |
| Red – White | 14.8 ± 1.5 | | | | | | | | | | | | | | | | |
| Position | Resistance value | | | | | | | | | | | | | | | | |
| Black – Red | 12.4 ± 1.2 | | | | | | | | | | | | | | | | |
| Black – White | 12.4 ± 1.2 | | | | | | | | | | | | | | | | |
| Red – White | 12.4 ± 1.2 | | | | | | | | | | | | | | | | |

8. REPLACEMENT OF SERVICE P.C. BOARD

Indoor Unit

CAUTION

<Model name: RAV-HM****BTP*>

For this model, please make all the following settings.

| CODE No.(DN) | Setting data | Description |
|--------------|--------------|--------------|
| E0 | 0004 | Global model |

<Note: when replacing the P.C. board for indoor unit servicing>

The nonvolatile memory (hereafter called EEPROM, IC503) on the indoor unit P.C. board before replacement includes the model specific type information and capacity codes as the factory-set value and the important setting data which have been automatically or manually set when the indoor unit is installed, such as system/indoor/group addresses, high ceiling select setting, etc.

When replacing the P.C. board for indoor unit servicing, follow the procedures below.

After replacement completes, confirm whether the settings are correct by checking the indoor unit No., Group header unit/follower unit settings and perform the cooling cycle confirmation through the trial operation.

<Replacement procedures>

CASE 1

Before replacement, the indoor unit can be turned on and the setting data can be read out by wired remote control operation.

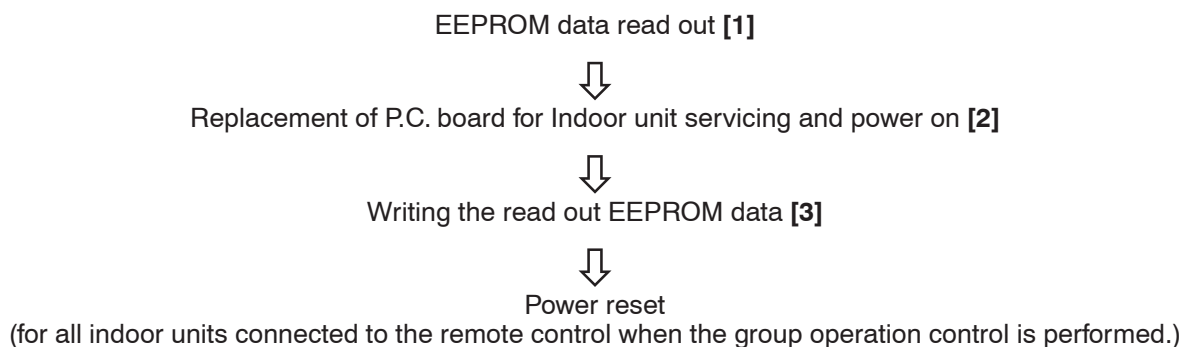

CASE 2

The EEPROM before replacement is trouble and the setting data cannot be read out.

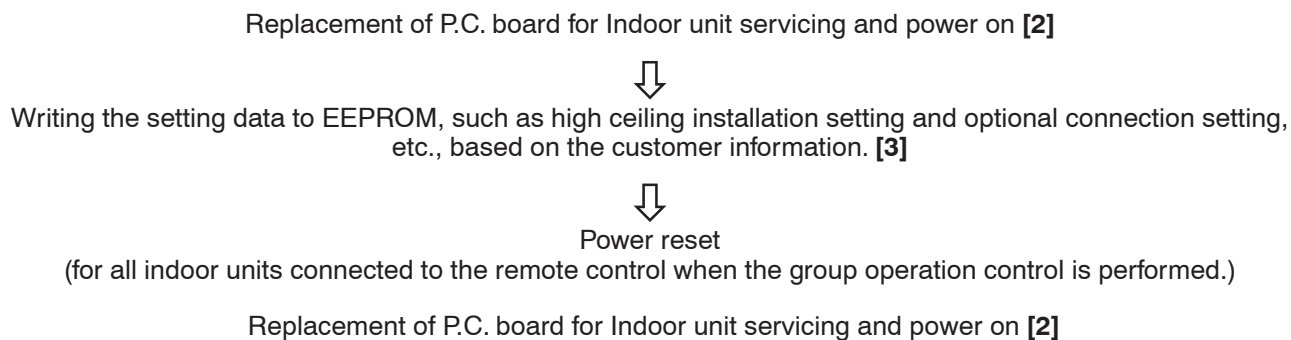

[1] Setting data read out from EEPROM

The setting data modified on the site, other than factory-set value, stored in the EEPROM shall be read out.

<RBC-ASCU1*>

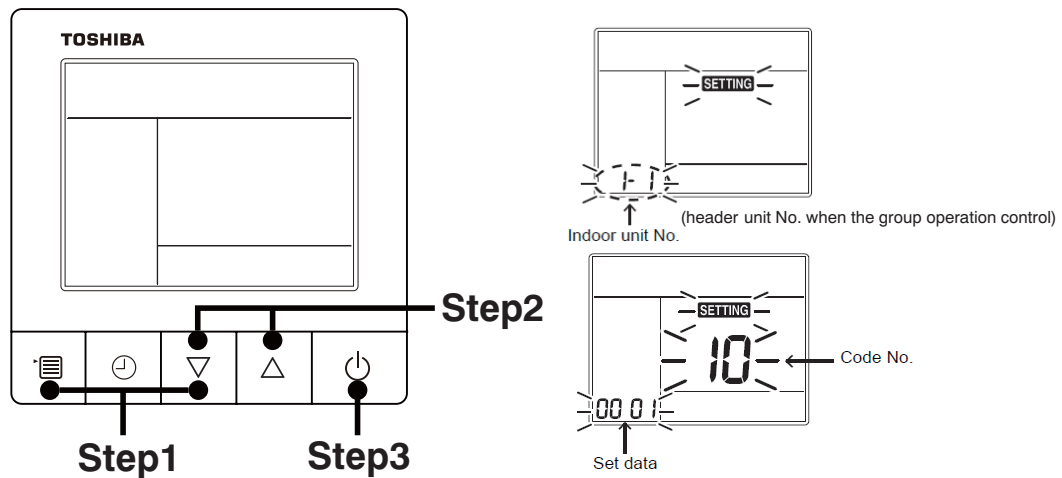

Step1 Push and hold the [menu + ▽] buttons at same time for more than 10 seconds.

* When the group operation control is performed, the unit No. displayed for the first time is the header unit No.

At this time, the Code No. (DN) shows “10”. Also, the fan of the indoor unit selected starts its operation and the swing operation also starts if it has the louvers.

Step2 Every time when the [▽ or △] button is pushed, the indoor unit No. under the group control is displayed in order. Specify the indoor unit No. to be replaced.

1. Change the Code No. (DN) to 10 → 01 by pushing [▽ or △] buttons setting. (this is the setting for the filter sign lighting time.)

At this time, be sure to write down the setting data displayed.

2. Change the Code No. (DN) by pushing [▽ or △] buttons.

Similarly, be sure to write down the setting data displayed.

3. Repeat the step 2-2 to set the other settings in the same way and write down the setting data as shown in the table 1 (example).

* The Code No. (DN) are ranged from “01” to “FE”. The Code No. (DN) may skip.

<RBC-AMTU3*>

Step 1 Push SET , UNIT LOUVER and TEST button on the remote controller simultaneously for more than 4 seconds.

* When the group operation control is performed, the unit No. displayed for the first time is the header unit No.

At this time, the CODE No. (DN) shows “i0”. Also, the fan of the indoor unit selected starts its operation and the swing operation also starts if it has the louvers.

Step 2 Every time when the UNIT LOUVER (left side button) button is pushed, the indoor unit No. under the group control is displayed in order. Specify the indoor unit No. to be replaced.

1. **Change e the CODE No. (DN) to i0 → 01 by pushing ▽ / △ buttons for the temperature setting. (this is the setting for the filter sign lighting time.)**

At this time, be sure to write down the setting data displayed.

2. Change the CODE No. (DN) by pushing ▽ / △ buttons for the temperature setting.

Similarly, be sure to write down the setting data displayed.

3. Repeat the step 2-2 to set the other settings in the same way and write down the setting data as shown in the table 1 (example).

* The CODE No. (DN) are ranged from “01” to “FE”. The CODE No. (DN) may skip.

CODE No. required at least

| DN | Contents |
|----|----------------------|
| 10 | Type |
| 11 | Indoor unit capacity |
| 12 | Line address |
| 13 | Indoor unit address |
| 14 | Group address |
| E0 | Destination |

1. The Code No. for the Indoor unit type and Indoor unit capacity are required to set the rotation number setting of the fan.
2. If the system/indoor/group addresses are different from those before replacement, the auto-address setting mode starts and the manual resetting may be required again.
(when the multiple units group operation including twin system.)

Step3 After writing down all setting data, push [ON/OFF] button to return to the normal stop status.
(It takes approx. 1 min until the remote controller operation is available again.)

[2] P.C. Board for indoor unit servicing replacement procedures

Step 1 Replace the P.C. board to the P.C. board for indoor unit servicing.

At this time, perform the same setting of the jumper wire(J01, J550, J551)setting(cut),switch SW501, (short-circuit) connector CN34 as the setting of the P.C. board before replacement.

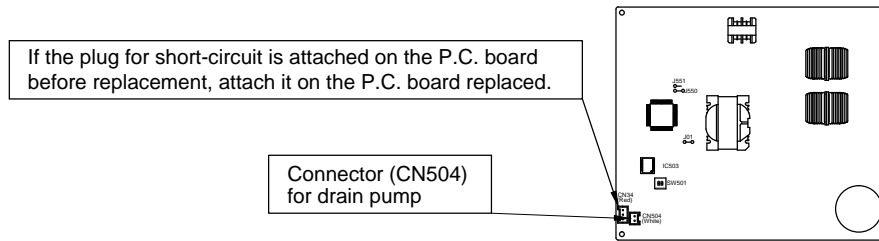

Step 2 According to the system configuration, turn on the indoor unit following to the either methods shown below.

a) Single operation (Indoor unit is used as standalone.)

Turn on the indoor unit.

1. After completion of the auto-address setting mode (required time: approx. 5 min.), proceed to [3]. (Line address = 1, Indoor unit address = 1, Group address = 0 (standalone) are automatically set.)
2. Push the following button on the wired remote controller to interrupt the automatic addressing mode and proceed to [3]. (The unit number "ALL" is displayed.)
 - RBC-ASCU1*: [menu] + [▽], 10 seconds or more
 - RBC-AMTU3*: [SET] + [CL] + [TEST], 4 seconds or more
 - RCB-AMSU5*: [MENU] + [V], 4 seconds or more

* Code No. (DN) [100] and later cannot be set, so after setting the address (DN [12], [13], [14]), restart and proceed to [3].

b) Group operation (including twin system)

Turn on the indoor unit(s) with its P.C. board replaced to the P.C. board for indoor unit servicing, according to either methods 1 or 2 shown below.

1. Turn on only the indoor unit with its P.C. board replaced. (Be sure to confirm the remote controller is surely connected. If not, the operation [3] cannot be performed.)
Then, the method a) above is performed.
2. Turn on the multiple indoor units including the indoor unit with its P.C. board replaced.
 - Twin 1 system only
 - All group connections

After completion of the auto-address setting mode (required time: approx. 5 min.), proceed to [3].

* The header unit of the group may be changed by performing the auto-address setting.

Also, the system address/Indoor unit address of the indoor unit with its P.C. board replaced may be assigned to the addresses (not used) other than those of the indoor units without its P.C. board replaced.

It is recommended to keep the information in advance, which refrigerant system the indoor unit belongs to or whether the indoor unit works as the header unit or the follower unit in the group control operation.

[3] Writing the setting data to EEPROM

<RBC-ASCU1*>

The settings stored in the EEPROM of the P.C. board for indoor unit servicing are the factory-set values.

Step 1 Push and hold the [menu + ▽] buttons at same time for more than 10 seconds.

* When the group operation control is performed, the unit No. displayed for the first time is the header unit No.

At this time, the Code No. (DN) shows "10". Also, the fan of the indoor unit selected starts its operation and the swing operation also starts if it has the louvers.

Step 2 Every time when the [▽ or △] button is pushed, the indoor unit No. in the group control operation are displayed in order.

(The settings stored in the EEPROM of the P.C. board for indoor unit servicing are the factory-set values.)

Specify the indoor unit No. with its P.C. board replaced to the P.C. board for indoor unit servicing. (You cannot perform this operation if "ALL" is displayed.)

Step 3 Select the Code No. (DN) can be selected by pushing the [▽ or △] button.

• Set the indoor unit type and capacity.

The factory-set values shall be written to the EEPROM by changing the type and capacity.

1. Push the [menu] button to make Code No. flash. And set the Code No. (DN) to 10 .

2. Push the [menu] button to make SET DATA flash. And select the type by pushing the [•□ or •⊕] buttons.

(For example, Concealed Duct Type is set to "0004". Refer to table 2)

3. Push [OFF timer] button.

(The changed data is set.)

4. Change the Code No. (DN) to "11" by pushing the [▽ or △] buttons.

5. Select the capacity by pushing the [▽ or △] buttons.

(For example, 160 Type is set to "0018". Refer to table 2)

6. Push [OFF timer] button.

(The changed data is set.)

Step 4 Write the on-site setting data to the EEPROM, such as address setting, etc. Perform the steps 1 and 2 above again.

Step 5 Change the Code No. (DN) to "01" by pushing the [▽ or △] buttons. (this is the setting for the filter sign lighting time.)

Step 6 Check the setting data displayed at this time with the setting data put down in [1].

1. If the setting data is different, modify the setting data by pushing the [▽ or △] buttons to the data put down in [1].

2. If the data is the same, proceed to next step.

Step 7 Change the Code No. (DN) by pushing the [▽ or △] buttons.

As described above, check the setting data and modify to the data put down in [1].

Step 8 Repeat the steps 6 and 7.

Step 9 After the setting completes, push the [ON/OFF] button to return to the normal stop status. (It takes approx. 1 min until the remote controller operation is available again.)

<RBC-AMTU3*>

The settings stored in the EEPROM of the P.C. board for indoor unit servicing are the factory-set values.

Step 1 Push , and buttons on the remote controller simultaneously for more than 4 seconds.

- * In the group control operation, the unit No. displayed for the first time is the header unit No..
At this time, the CODE No. (DN) shows “ ”. Also, the fan of the indoor unit selected starts its operation and the swing operation starts if it has the louvers.
(The unit No. “ ” is displayed if the auto-address setting mode is interrupted in [2] step 2 a)

Step 2 Every time when (left side button) button is pushed, the indoor unit No. in the group control operation are displayed in order.
(The settings stored in the EEPROM of the P.C. board for indoor unit servicing are the factory-set values.)

Specify the indoor unit No. with its P.C. board replaced to the P.C. board for indoor unit servicing.
(You cannot perform this operation if “ ” is displayed.)

Step 3 Select the CODE No. (DN) can be selected by pushing the / button for the temperature setting.

- Set the indoor unit type and capacity.
The factory-set values shall be written to the EEPROM by changing the type and capacity.

1. Set the CODE No. (DN) to “ ”. (without change)
2. Select the type by pushing / buttons for the timer setting.
(For example, Concealed Duct Type is set to “0004”. Refer to table 2)
3. Push button.
(The operation completes if the setting data is displayed.)
4. Change the CODE No. (DN) to “ ” by pushing / buttons for the temperature setting.
5. Select the capacity by pushing / buttons for the timer setting.
(For example, 160 Type is set to “ 0018 ”. Refer to table 2)
6. Push button.
(The setting completes if the setting data are displayed.)
7. Using the set temperature / buttons, set “ ” to the CODE No. (DN).
8. Using the timer time / buttons, set the dat. (0001)
9. Push button (The setting completes if the setting data are displayed.)
10. Push the button to return to the normal stop status
(It takes approx. 1 min until the remote control operation is available again.)

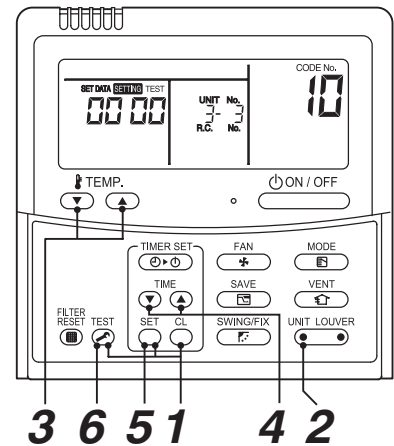

Step 4 Write the on-site setting data to the EEPROM, such as address setting, etc. Perform the steps 1 and 2 above again.

Step 5 Change the CODE No. (DN) to “ ” by pushing / buttons for the temperature setting.
(this is the setting for the filter sign lighting time.)

Step 6 Check the setting data displayed at this time with the setting data put down in [1].

1. If the setting data is different, modify the setting data by pushing / buttons for the timer setting to the data put down in [1].
The operation completes if the setting data is displayed.
2. If the data is the same, proceed to next step.

Step 7 Change the CODE No. (DN) by pushing / buttons for the temperature setting.
As described above, check the setting data and modify to the data put down in [1].

Step 8 Repeat the steps 6 and 7.

Step 9 After the setting completes, push button to return to the normal stop status.
(It takes approx. 1 min until the remote control operation is available again.)

- * Even after modifying the data wrongly and pushing button, it is possible to return to the data before modification by pushing button if the CODE No. (DN) is not changed.

Table 1. Type: CODE No. 10

| Setting data | Type | Type name abb. |
|--------------|---------------------|----------------|
| 0001* | 4-way Cassette Type | RAV-HM****UTP* |
| 0004 | Concealed Duct Type | RAV-HM****BTP* |

* **⚠ CAUTION**
 <Model name: RAV-HM****BTP*>
 For this model, please make all the following settings.

| CODE No.(DN) | Setting data | Description |
|--------------|--------------|--------------|
| E0 | 0004 | Global model |

● For other CODE No., refer to “Function CODE No. (DN Code) table” on page 77.

Table 2. Indoor unit capacity: CODE No. 11

| Setting data | Type |
|--------------|---------|
| 0000* | Disable |
| 0009 | 56 |
| 0012 | 80 |
| 0013 | 90 |
| 0015 | 110 |
| 0017 | 140 |
| 0018 | 160 |

* EEPROM initial value on the P.C. board for indoor unit servicing.

9. SETUP AT LOCAL SITE AND OTHERS

9-1. Indoor Unit

9-1-1. Test Run Setup on Remote Controller

<RBC-ASCU1*>

Be sure to stop the air conditioner before making settings.

(Change the setup while the air conditioner is not working.)

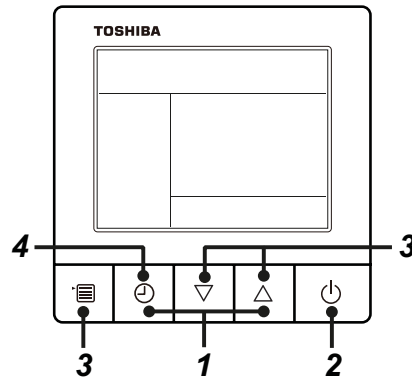

- 1** Push and hold OFF timer button and [Δ] setting button simultaneously for 10 seconds or more. [TEST] is displayed on the display part and the test run is permitted.

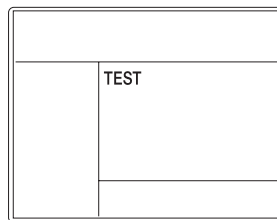

- 2** Push ON/OFF button.

- 3** Push menu button to select the operation mode. Select [\odot Cool] or [\odot Heat] with [∇] [Δ] setting button.



- Do not run the air conditioner in a mode other than [Cool] or [Heat].
- The temperature setting function does not work during test run.
- The check code is displayed as usual.

- 4** After the test run, push OFF timer button to stop a test run.

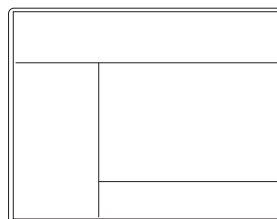
([TEST] disappears on the display and the air conditioner enters the normal stop mode.)





<RBC-AMTU3*>

1. When pushing  button on the remote controller for 4 seconds or more, "TEST" is displayed on LC display. Then push  button.
 - "TEST" is displayed on LC display during operation of Test Run.
 - During Test Run, temperature cannot be adjusted but air volume can be selected.
 - In heating and cooling operation, a command to fix the Test Run frequency is output.
 - Detection of trouble is performed as usual. However, do not use this function except case of Test Run because it applies load on the unit.
2. Use either heating or cooling operation mode for [TEST].

NOTE : The outdoor unit does not operate after power has been turned on or for approx. 3 minutes after operation has stopped.
3. After a Test Run has finished, push  button again and check that [TEST] on LC display has gone off. (To prevent a continuous test run operation, 60-minutes timer release function is provided to this remote controller.)

<Wireless remote controller>

- 1 Turn on the power of the air conditioner.
When power is turned on for the first time after installation, it takes approx. 5 minutes until the remote controller becomes available. In the case of subsequent power-on, it takes approx. 1 minute until the remote controller becomes available.
Execute a test run after the predetermined time has passed.
- 2 Push "ON/OFF" button on the remote controller, select [ Cool] or [ Heat] with "MODE" button, and then select [ HIGH] with "FAN" button.

3

| Cooling test run | Heating test run |
|--|--|
| Set the temperature to 17 °C with the temp. setup buttons. | Set the temperature to 30 °C with the temp. setup buttons. |

4

| Cooling test run | Heating test run |
|---|---|
| After confirming a signal receiving sound "beep" immediately set the temperature to 18 °C with the temp. setup buttons. | After confirming a signal receiving sound "beep" immediately set the temperature to 29 °C with the temp. setup buttons. |

5

| Cooling test run | Heating test run |
|---|---|
| After confirming a signal receiving sound "beep" Immediately set the temperature to 17 °C with the temp. setup buttons. | After confirming a signal receiving sound "beep" immediately set the temperature to 30 °C with the temp. setup buttons. |

- 6 Repeat procedures **4 → 5 → 4 → 5**.
Indicators "Operation" (green), "Timer" (green), and "Ready" (orange) in the wireless receiver section flash in approx. 10 seconds, and the air conditioner starts operation. If any of these indicators does not flash, repeat procedures 2 to 5.
- 7 Upon completion of the test run, push "ON/OFF" button to stop operation.

<Overview of test run operations using the wireless remote controller>

▼ **Cooling test run:**

ON/OFF → 18 °C → 17 °C → 18 °C → 17 °C → 18 °C → 17 °C → 18 °C → (test run) → ON/OFF

▼ **Heating test run:**

ON/OFF → 29 °C → 30 °C → 29 °C → 30 °C → 29 °C → 30 °C → 29 °C → (test run) → ON/OFF

NOTE :

To prevent a continuous test run operation, 60 minutes timer release function is provided to this remote controller.

9-1-2. Forced Defrost Setup of Remote Controller (For wired remote controller only)

(Preparation in advance)

- Set the following CODE No. (DN) with the wired remote controller.
CODE No.(DN) : 8C
Set data : 0000 (Factory default) → 0001

(Practical operation)

- Push ON/OFF button.
- Select the HEAT mode.
- After a while, the forced defrost signal is sent to the outdoor unit and then the outdoor unit starts defrost operation. (The forced defrost operation is performed for Max. 12 minutes.)
- After defrost operation finished, the operation returns to the heating operation.

To execute the defrost operation again, start procedure from above DN setting.

(If the forced defrost operation was executed once, setting of the above forced defrost operation is cleared.)

9-1-3. LED Display on P.C. Board

1. D501 (Red)

- It goes on (Goes on by operation of the main microcomputer) at the same time when the power supply is turned on.
- It flashes with 1-second interval (every 0.5 second): When there is no EEPROM or writing-in operation fails.
- It flashes with 10-seconds interval (every 5 second): During DISP mode
- It flashes with 2-seconds interval (every 1 second): While setting of function select (EEPROM)

2. D403 (Red)

- It goes on when power supply of the remote controller is turned on. (Lights on hardware)

3. D503 (Yellow): Main bus communication

- For the indoor unit connecting to the central control device, D503 alternates between flashing for 5 seconds and lighting for 5 seconds when the PC board receives the communication signal.
- For the indoor unit disconnecting to the central control device, D503 flashes every 5 seconds when the air conditioner continues to stop the operation.

4. D504 (Green): Sub bus communication

- It flashes for 5 seconds in the first half of communication with the remote controller. (Group header unit)
- It flashes with 0.2-second interval (for 0.1 second) for 5 second in the latter half of communication between header and follower in the Gr indoor unit.

5. D14 (Orange)

- It flashes while receiving the serial signal from the outdoor unit. (Hardware)

6. D15 (Green)

- It flashes while sending the serial signal to the outdoor unit. (Hardware)

9-1-4. Function Selection Setup

<Procedure> Perform setting while the air conditioner stops.

<RBC-ASCU1*>

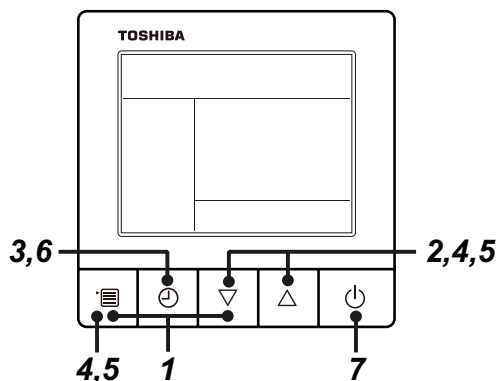

1 Push and hold menu button and [▽] setting button simultaneously for 10 seconds or more.

- After a while, the display flashes as shown in the figure. “ALL” is displayed as indoor unit numbers during initial communication immediately after the power has been turned on.

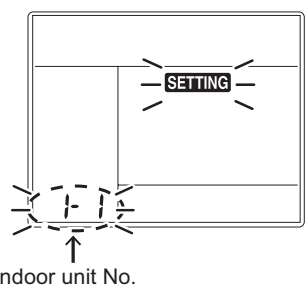

2 Each time [▽][△] setting button is pushed, indoor unit numbers in the group control change cyclically. Select the indoor unit to change settings for.

- The fan of the selected indoor unit runs. The indoor unit can be confirmed for which to change settings.

3 Push OFF timer button to confirm the selected indoor unit.

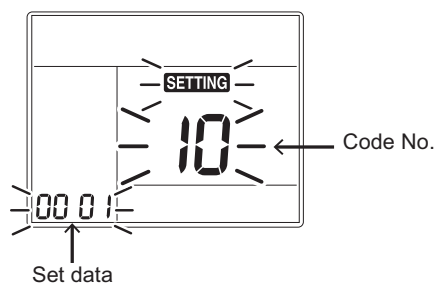

4 Push the menu button to make Code No. [**] flash. Change Code No. [**] with [▽][△] setting button.

5 Push the menu button to make Set data [**] flash. Change Set data [****] with [▽][△] setting button.**

6 Push OFF timer button to complete the set up.

- To change other settings of the selected indoor unit, repeat from Procedure 4.

7 When all the settings have been completed, push ON/OFF button to finish the settings. (Return to the normal mode)

“SETTING” flashes and then the display content disappears and the air conditioner enters the normal stop mode. (The remote controller is unavailable while “SETTING” is flashing.)

- To change settings of another indoor unit, repeat from Procedure 1.

<RBC-AMTU3*>

- 1** Push the  +  +  buttons simultaneously and hold for at least 4 seconds.

The unit No. displayed first is the address of the header indoor unit in group control.

Then the fan and louver of the selected indoor unit move.

- 2** Each time the  button (left side of the button) is pressed, one of the indoor unit Nos. under group control is displayed in turn. Then the fan and louver of the selected indoor unit move.

- 3** Use the  button to select the CODE No. (DN code) of the desired function.

- 4** Use the  button to select the desired SET DATA associated with the selected function.

- 5** Push the  button. (The display changes from flashing to steady.)

- To change the selected indoor unit, go back to step **2**.
- To change the selected function, go back to step **3**.

- 6** When the  button is pushed, the system returns to normal off state.

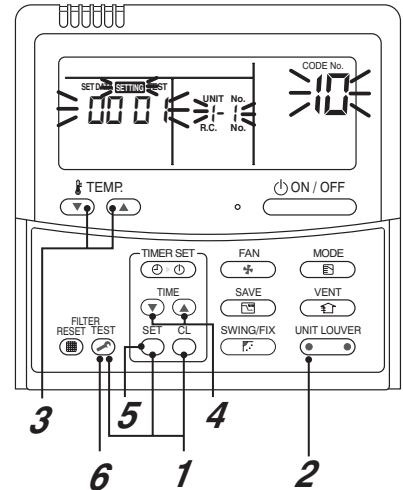

NOTE :

For details on how to operate other remote controllers, refer to the remote controller manual.

Function CODE No. (DN Code) table (includes all functions needed to perform applied control on site)

| DN | Item | Description | At shipment |
|----|---|--|----------------------------|
| 01 | Filter display delay timer | 0000: None 0002: 2500H 0004: 10000H 0001: 150H 0003: 5000H | 0002 : 2500H |
| 02 | Dirty state of filter | 0000: Standard 0001: High degree of dirt (Half of standard time) | 0000: Standard |
| 03 | Central control address | 0001: No.1 unit to 0128: No.128 unit ... TU2C-Link 0001: No.1 unit to 0064: No.64 unit ... TCC-Link 00Un: Unfixed (When using U series remote controller) 0099: Unfixed (Other than U series remote controller) | 00Un/0099: Unfixed *1 |
| 04 | Specific indoor unit priority | 0000: No priority 0001: Priority | 0000: No priority |
| 06 | Heating temp shift | 0000: 0 °C 0002: +2 °C to 0001: +1 °C 0010: +10 °C (Up to +6 recommended) | 0002 : +2°C |
| 0d | Existence of [AUTO] mode | 0000: Provided 0001: Not provided (Automatic selection from connected outdoor unit) | 0000: Provided |
| 0F | Cooling only | 0000: Heat pump 0001: Cooling only (No display of [AUTO] [HEAT]) | 0000: Heat pump |
| 10 | Type | 0001 : 4-way Cassette 0000 : 1-way Cassette to 0038 | 0001 : 4-way Cassette |
| 11 | Indoor unit capacity | 0000: Unfixed 0001 to 0039 | According to capacity type |
| 12 | Line address | 0001: No.1 unit to 0128: No.128 unit ... TU2C-Link 0001: No.1 unit to 0030: No.30 unit ... TCC-Link 00Un: Unfixed (When using U series remote controller) 0099: Unfixed (Other than U series remote controller) | 00Un/0099: Unfixed *1 |
| 13 | Indoor unit address | 0001: No.1 unit to 0128: No.128 unit ... TU2C-Link 0001: No.1 unit to 0064: No.64 unit ... TCC-Link 00Un: Unfixed (When using U series remote controller) 0099: Unfixed (Other than U series remote controller) | 00Un/0099: Unfixed *1 |
| 14 | Group address | 0000: Individual 0002: Follower unit of group 00Un: Unfixed (When using U series remote controller) 0099: Unfixed (Other than U series remote controller) 0001: Header unit of group | 00Un/0099: Unfixed *1 |
| 1E | Temp difference of [AUTO] mode selection COOL → HEAT, HEAT → COOL | 0000: 0 °C to 0020: 20 °C (For setup temperature, reversal of COOL / HEAT by } (Data value) / 2) | 0003: 3 °C (Ts ±1.5) |
| 28 | Automatic restart of power failure | 0000: None 0001: Restart | 0000: None |
| 2A | Selection of option/Trouble input (TCB-PCUC2E: CN3) | 0000: Filter input 0002: None 0001: Alarm input (Air washer, etc.) | 0002: None |
| 2E | HA terminal (CN61) select | 0000: Usual 0002: Fire alarm input 0001: Leaving-ON prevention control | 0000: Usual (HA terminal) |
| 31 | Ventilating fan control | 0000: Unavailable 0001: Available | 0000: Unavailable |
| 32 | TA sensor selection | 0000: Body TA sensor 0001: Remote controller sensor | 0000: Body TA sensor |
| 33 | Temperature unit select | 0000: °C (at factory shipment) 0001: °F | 0000: °C |
| 5d | High-ceiling adjustment (Air flow selection) | | 0000: Standard |
| 60 | Timer setting (wired remote controller) | 0000: Available (can be performed) 0001: Unavailable (cannot be performed) | 0000: Available |

| DN | Item | Description | | At shipment |
|-----|---|--|---|--------------------------------|
| 77 | Dual set point | 0000: Unavailable | 0002: Available | 0000: Unavailable |
| 9A | Thermostat OFF fan speed in cooling mode | 0000: Remote controller setting 0002: Fan OFF | 0001: Extremely low speed (UL) 0003: Low speed (L) | 0001: Extremely low speed (UL) |
| b3 | Soft cooling | 0000: Unavailable | 0001: Available | 0001: Available |
| C2 | Power saving | 0050: 50% | to 0100: 100% | 0075: 75% |
| C5 | Secondary heating mode | 0000: Normal mode | 0001: Flip mode | 0000: Normal mode |
| C6 | Secondary heating Set Temp. out (high) | -0015: -15°C | to 0015: 15°C | 0000: 0°C |
| C7 | Secondary heating c Temp.(TOH-TOL)" | 0000: Unavailable 0001: 1°C | to 0010: 10°C | 0000: Unavailable |
| d0 | Whether the power saving mode can be set by the remote controller | 0000: Invalid | 0001: Valid | 0001: Valid |
| d1 | 8°C heating Frost protective operation | 0000: Unavailable | 0001: Available | 0000: Unavailable |
| db | Secondary heating b Temp.(TAH-TAL) | 0001: 0.5°C | to 0010: 5.0°C | 0006: 3.0°C |
| dc | Secondary heating a Temp. Normal mode (Ts-TAH) Flip mode (TAL-Ts) | 0000: Unavailable 0001: 1°C | to 0010: 10°C | 0000: Unavailable |
| E0 | Destination | 0000: Japan | 0004: Global | 0004: Global |
| F6 | Presence of Application control kit (TCB-PCUC2E) | 0000: None 0001: Exist | | 0000: None |
| Fb | Power shift | 0000: Unavailable | 0001: Available | 0000: Unavailable |
| FC | Communication protocol *2 | 0000: TCC-LINK | 0004: TU2C-LINK | 0004: TU2C-LINK |
| 120 | Defrost shift | 0000: Unavailable | 0001: Available | 0001: Available |
| 121 | Draft prevention control | 0000: Unavailable | 0001: Available | 0001: Available |
| 1C1 | Rotation operation | 0000: Unavailable | 0001: Available | 0000: Unavailable |
| 1C2 | Rotation interval | 0001: 1 day | to 0028: 28 days | 0001: 1 day |
| 1C3 | Rotation lap time | 0000: 0 | to 0007: 70 minutes | 0003: 30 minutes |
| 1C8 | Free Cooling | 0000: Unavailable | 0001: Available | 0000: Unavailable |
| 1C9 | Free Cooling ON Temp. | -0015: -15°C | to 0029: 29°C | 0016: 16°C |
| 1CA | Free Cooling OFF Temp. | -0015: -15°C | to 0029: 29°C | 0010: 10°C |
| 1Cb | Free Cooling ON/OFF differential Temp." | 0000: 0 | to 0010: 10°C | 0002: 2°C |
| 22B | Filter sign (Duct) | 0000: Unavailable | | 0000: Unavailable |
| | | DN [5D] | 0000 0001 0002 0003 0004 0005 0006 | |
| | | Static pressure | 30Pa 50Pa 40Pa 100Pa 65Pa 120Pa 150Pa | |
| | | 56 | 0082 0091 0086 0106 0097 0109 0115 | |
| | | 80 | 0081 0092 0085 0103 0097 0107 0112 | |
| | | Static pressure | 40Pa 30Pa 50Pa 100Pa 65Pa 120Pa 150Pa | |
| | | 90 | 0083 0082 0088 0098 0092 0100 0108 | |
| | | 110 | 0095 0091 0093 0102 0097 0106 0112 | |
| | | Static pressure | 50Pa 30Pa 40Pa 100Pa 65Pa 120Pa 150Pa | |
| | | 140 | 0095 0091 0093 0102 0097 0106 0112 | |
| 160 | 0095 0091 0093 0102 0097 0106 0112 | | | |

*1 Display order of "00Un" and "0099" varies depending on remote controller models or communication types.

For Central control address (DN [03]), Indoor unit address (DN [13])

| Remote controller | Communication type | Display order |
|---------------------|--------------------|--------------------------------|
| U series | TU2C-LINK | ... ⇔ 0128 ⇔ 00Un ⇔ 0001 ⇔ ... |
| | TCC-LINK | ... ⇔ 0064 ⇔ 00Un ⇔ 0001 ⇔ ... |
| Other than U series | TCC-LINK | ... ⇔ 0064 ⇔ 0099 ⇔ 0001 ⇔ ... |

For Line address (DN [12])

| Remote controller | Communication type | Display order |
|---------------------|--------------------|--------------------------------|
| U series | TU2C-LINK | ... ⇔ 0128 ⇔ 00Un ⇔ 0001 ⇔ ... |
| | TCC-LINK | ... ⇔ 0030 ⇔ 00Un ⇔ 0001 ⇔ ... |
| Other than U series | TCC-LINK | ... ⇔ 0030 ⇔ 0099 ⇔ 0001 ⇔ ... |

For Group address (DN [14])

| Remote controller | Communication type | Display order |
|---------------------|--------------------|--------------------------------|
| U series | TU2C-LINK | ... ⇔ 0002 ⇔ 00Un ⇔ 0000 ⇔ ... |
| | TCC-LINK | |
| Other than U series | TCC-LINK | ... ⇔ 0002 ⇔ 0099 ⇔ 0000 ⇔ ... |

*2 If indoor unit and the connected remote controller / remote sensor are all TU2C-Link models, TU2C-Link communication will be performed automatically.

9-1-5. Wiring and Setting of Remote Controller Control

2-remote controller control (Controlled by 2 remote controllers)

This control is to operate 1 or multiple indoor units are operated by 2 remote controllers.
(Max. 2 remote controllers are connectable.)

• When connected 2 remote controllers operate an indoor unit

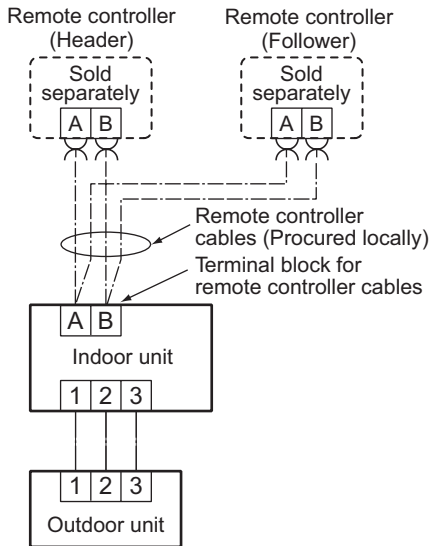

• When connected 2 remote controllers operate the twin

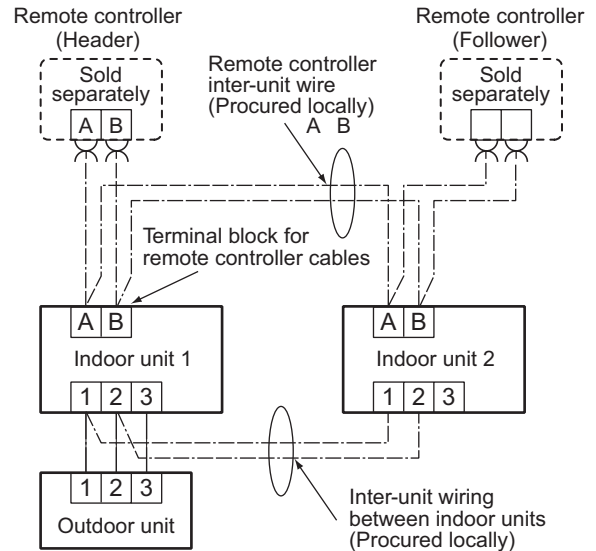

How to set remote controller as follower remote controller

<Wired remote controller>

RBC-ASCU1*

Remove the rear cover of the remote controller and change the DIP switch.

* Be sure to turn off the breaker first.

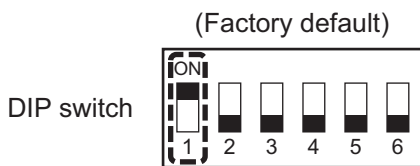

bit 1:

OFF= Header remote controller
(Factory default)

ON = Follower remote controller

<Wireless remote controller>

RBC-AXU31U*

Remove the rear cover of the remote controller and change the DIP switch.

* Be sure to turn off the breaker first.

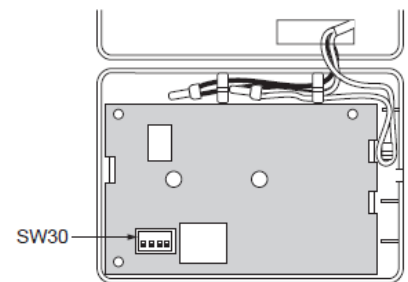

DIP switch [SW30]

| | | |
|---|-------------|------------|
| 4 | ON=follower | OFF=header |
| 3 | ON=B | OFF=A |
| 2 | Not used | |
| 1 | Not used | |



NOTE:

- For details on how to operate other remote controllers, refer to the remote controller manual.

[Operation]

1. The operation contents can be changed by Last-push-priority.
2. Use the timer function on the Header remote controller.

<Wireless remote controller>

Wireless remote controller A-B selection

Using 2 wireless remote controllers for the respective air conditioners, when the 2 air conditioners are closely installed. Address (A-B selection) must be changed on both signal receiving unit and wireless remote controller.

Wireless remote controller B setup

1. Push the START/STOP button to operate the air conditioner. Push it again to stop the air conditioner.
2. Push [Temporary] button on the signal receiving unit to operate the air conditioner.
3. Point the wireless remote controller at the indoor unit.
4. Push and hold **CHK** button on the wireless remote controller by the tip of the pencil. "00" will be shown on the display.
5. Push the MODE button during pushing **CHK**.

"B" will be shown on the display and "00" will be disappear and the air conditioner will turn OFF. The wireless remote controller B is memorized.

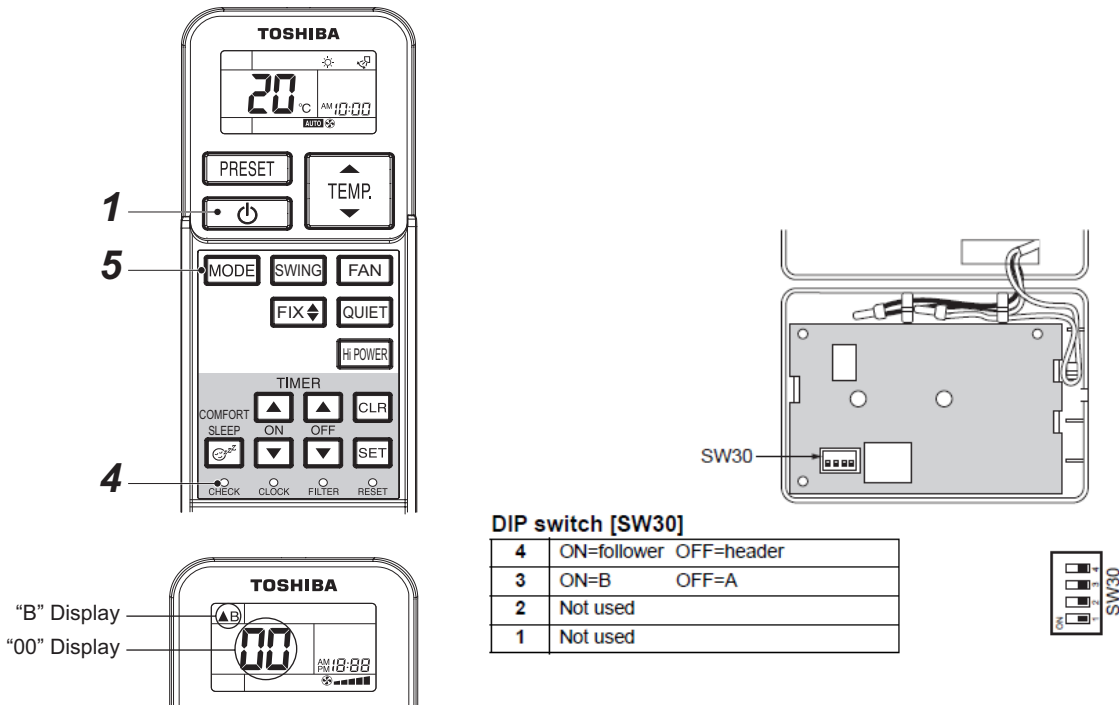

Note:

- Repeat above step to reset wireless remote controller to be A.
- The wireless remote controllers do not display "A".
- The factory default of the wireless remote controllers is "A".

Signal receiving unit (A-B selection) setting

1. Turn off the indoor unit power supply.
2. Remove the screw on the signal receiving unit cover and then remove the signal receiving cover.
3. Turn on the bit 3 of DIP switch SW30 on the signal receiving unit P.C. board.

9-1-6. Monitor Function of Remote Controller Switch

■ Calling of sensor temperature display

<Contents>

Each data of the remote controller, indoor unit and outdoor unit can be understood by calling the service monitor mode from the remote controller.

<Procedure>

<RBC-ASCU1*>

- 1** Push the [menu] button for over 10 seconds.
- 2** Every pushing [▽] [△] buttons, the indoor unit numbers in group control are displayed successively.
- 3** Push the [OFF timer] button to confirm the selected indoor unit.
- 4** Every pushing [▽] [△] buttons, CODE No. of the item is changed successively.
- 5** After you have finished checking, push the [ON/OFF] button to return to normal mode.

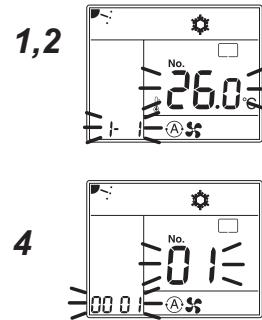
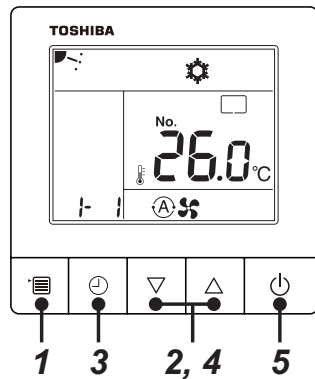

<RBC-AMTU3*>

- 1** Push **TEST** + **ON/OFF** buttons simultaneously for 4 seconds or more to call up the service monitor mode.
The service monitor goes on, and temperature of the CODE No. 00 is firstly displayed.
- 2** Push the temperature setup **TEMP.** buttons to select the CODE No. to be monitored.
For displayed codes, refer to the table next page.
- 3** Push **SET** button to determine the item to be monitored.
Then monitor the sensor temperature or operation status of indoor unit and the outdoor unit in the corresponding refrigerant line.
- 4** Pushing **TEST** button returns the display to the normal display.

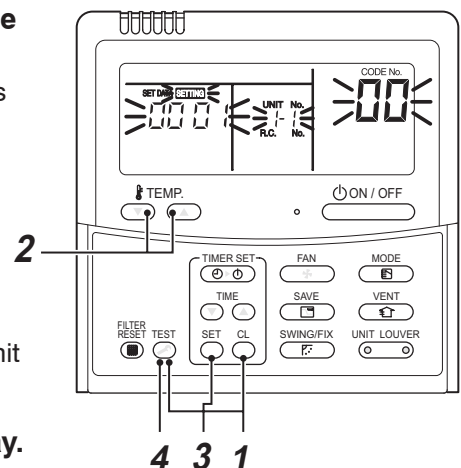

| Indoor unit data | CODE No. | Data name | Unit |
|------------------|----------|--|-------|
| | 01 | Room temperature (Remote controller) | °C |
| | 02 | Indoor suction temperature (TA) | °C |
| | 03 | Indoor heat exchanger (Coil) temperature (TCJ) | °C |
| | 04 | Indoor heat exchanger (Coil) temperature (TC) | °C |
| | 07 | Indoor fan revolution frequency | rpm |
| | B9 | Communication protocol 0000: TCC-LINK, 0001: TU2C-LINK | |
| | F2 | Indoor fan calculated operation time | ×100h |
| | F3 | Filter sign time | ×1h |
| | F8 | Indoor unit discharge air temperature (TF) *1 | °C |
| | E5 | Secondary heating output ---- : Unavailable 0000 : OFF, 0001 : ON | |
| | E6 | Free cooling output ---- : Unavailable 0000 : OFF, 0001 : ON | |
| | E9 | Rotation operation ---- : Unavailable 0000 : Rotation operation OFF 0001 : Rotation operation ON, Unit ON 0002 : Rotation operation ON, Unit OFF | |

| Outdoor unit data *2 | CODE No. | Data name | Unit |
|----------------------|----------|--|-------|
| | 60 | Outdoor heat exchanger (Coil) temperature (TE) | °C |
| | 61 | Outside temperature (TO) | °C |
| | 62 | Compressor discharge temperature (TD) | °C |
| | 63 | Compressor suction temperature (TS) | °C |
| | 65 | Heat sink temperature (TH) | °C |
| | 6A | Operation current (× 1/10) | A |
| | 6D | Outdoor heat exchanger (Coil) temperature (TL) | °C |
| | 70 | Compressor operation frequency | rps |
| | 72 | Outdoor fan revolution frequency (Lower) | rpm |
| | 73 | Outdoor fan revolution frequency (Upper) | rpm |
| | F1 | Compressor calculated operation time | ×100h |

*1 : The above temperature values are estimated from the temperature of the heat exchanger. It may differ from the actual discharge temperature.

*2 : For outdoor unit data, refer to the Installation Manual and Service Manual of the outdoor unit.

■ Calling of trouble history

<Contents>

The trouble contents in the past can be called.

<Procedure>

<RBC-ASCU1*>

(1) Confirmation and check

If a problem occurs with the air conditioner, the OFF timer indicator alternately shows the check code and the indoor Unit No. in which the problem occurred.

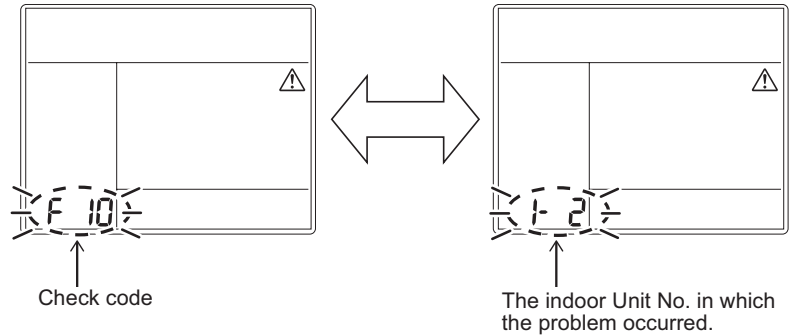

(2) Troubleshooting history and confirmation

You can check the troubleshooting history with the following procedure if a problem occurs with the air conditioner.

(The troubleshooting history records up to 4 incidents.)

You can check it during operation or when operation is stopped.

- If you check the troubleshooting history during OFF timer operation, the OFF timer will be canceled.

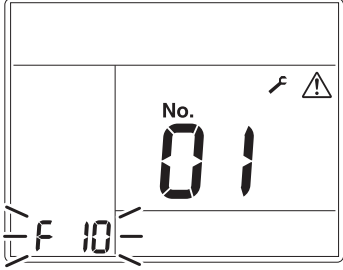
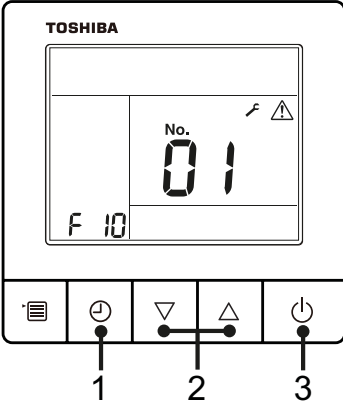
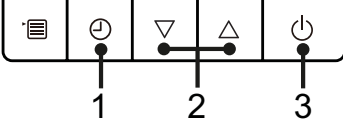
| Procedure | Description of operation | |
|-----------|--|--|
| 1 | <p>Push the OFF timer button for over 10 seconds and the indicators appear as an image indicating the troubleshooting history mode has been entered. If [ Service check] is displayed, the mode enters in the troubleshooting history mode.</p> <ul style="list-style-type: none"> • [01: Order of troubleshooting history] appears in the temperature indicator. • The OFF timer indicator alternately shows the [check code] and the [indoor Unit No.] in which the problem occurred. |  |
| 2 | <p>Each time the setting button is pushed, the recorded troubleshooting history is displayed in sequence. The troubleshooting history appears in order from [01] (newest) to [04] (oldest).</p> <p>CAUTION</p> <p>In the troubleshooting history mode, DO NOT push the Menu button for over 10 seconds, doing so deletes the entire troubleshooting history of the indoor unit.</p> |  |
| 3 | <p>After you have finished checking, push the ON/OFF button to return to the regular mode.</p> <ul style="list-style-type: none"> • If the air conditioner is operating, it remains operated even after the ON/OFF button has been pushed. To stop its operation, push the ON/OFF button again. |  |

<RBC-AMTU3*>

1 Push **SET** + **TEST** buttons simultaneously for 4 seconds or more to call the service check mode.

Service Check goes on, the **CODE No. 01** is displayed, and then the content of the latest alarm is displayed.
The number and trouble contents of the indoor unit in which a trouble occurred are displayed.

2 In order to monitor another trouble history, push the set temperature **▼** / **▲** buttons to change the trouble history No. (**CODE No.**)

CODE No. 01 (Latest) → **CODE No. 04** (Old)
NOTE : 4 trouble histories are stored in memory.

3 Pushing **TEST** button returns the display to usual display.

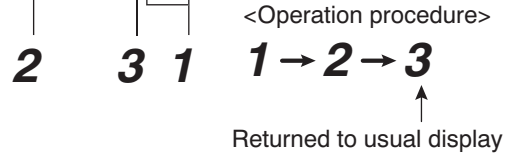
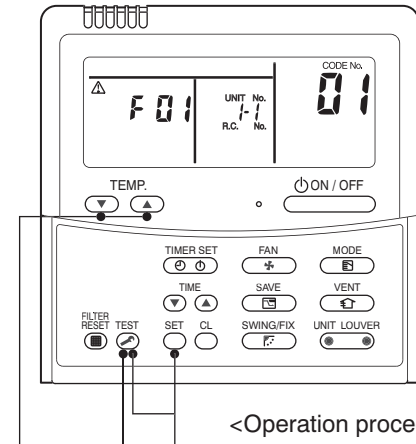

REQUIREMENT

Do not push **CL** button, otherwise all the trouble histories of the indoor unit are deleted. If the trouble histories are deleted by pushing **CL** button, turn off the power supply once and then turn on the power supply again. When the trouble which is same as one occurred at the last before deletion continuously occurs again, it may not be stored in memory.

(Group control operation)

In a group control, operation of up to 16 units (TU2C-Link) / 8 units (TCC-Link) can be controlled by a remote controller.
Twin of an outdoor unit is one of the group controls.
The indoor unit connected with outdoor unit (Individual/Header of twin) controls room temperature according to setting on the remote controller.

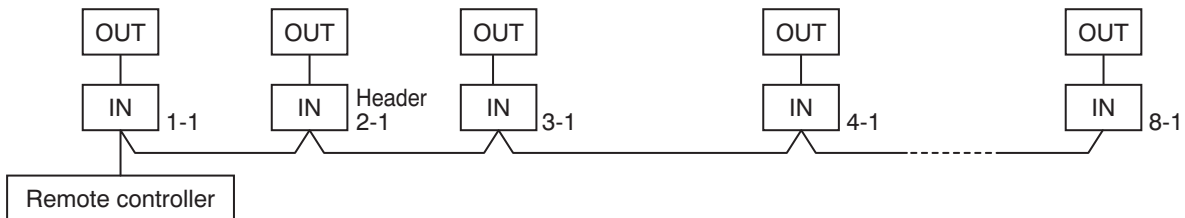

<System example>

1. Display range on remote controller
The setup range (Operation mode / Fan speed / Set temperature) of the indoor unit which was set to the header unit is reflected on the remote controller.
2. Address setup
If there is no serial communication between indoor and outdoor when the power is turned on, it is judged as follower unit of the twin. (Every time when the power is turned on)
 - The judgment of header (wired) / follower (simple) of twin is carried out every time. It is not stored in nonvolatile memory.

Turn on power of the indoor unit to be controlled in a group within 3 minutes after setting of automatic address. If power of the indoor unit is not turned on within 3 minutes (completion of automatic address setting), the system is rebooted and the automatic address setting will be judged again.

 - 1) Connect indoor/outdoor connecting wire surely.
 - 2) Check line address/indoor address/group address of the unit one by one.
Especially in case of twin check whether they are identical system address or not.
 - 3) The unit No. (line/indoor gout address) which have been set once keep the present status as a rule if the unit No. is not duplicated with one of another unit.

Indoor unit power-ON sequence

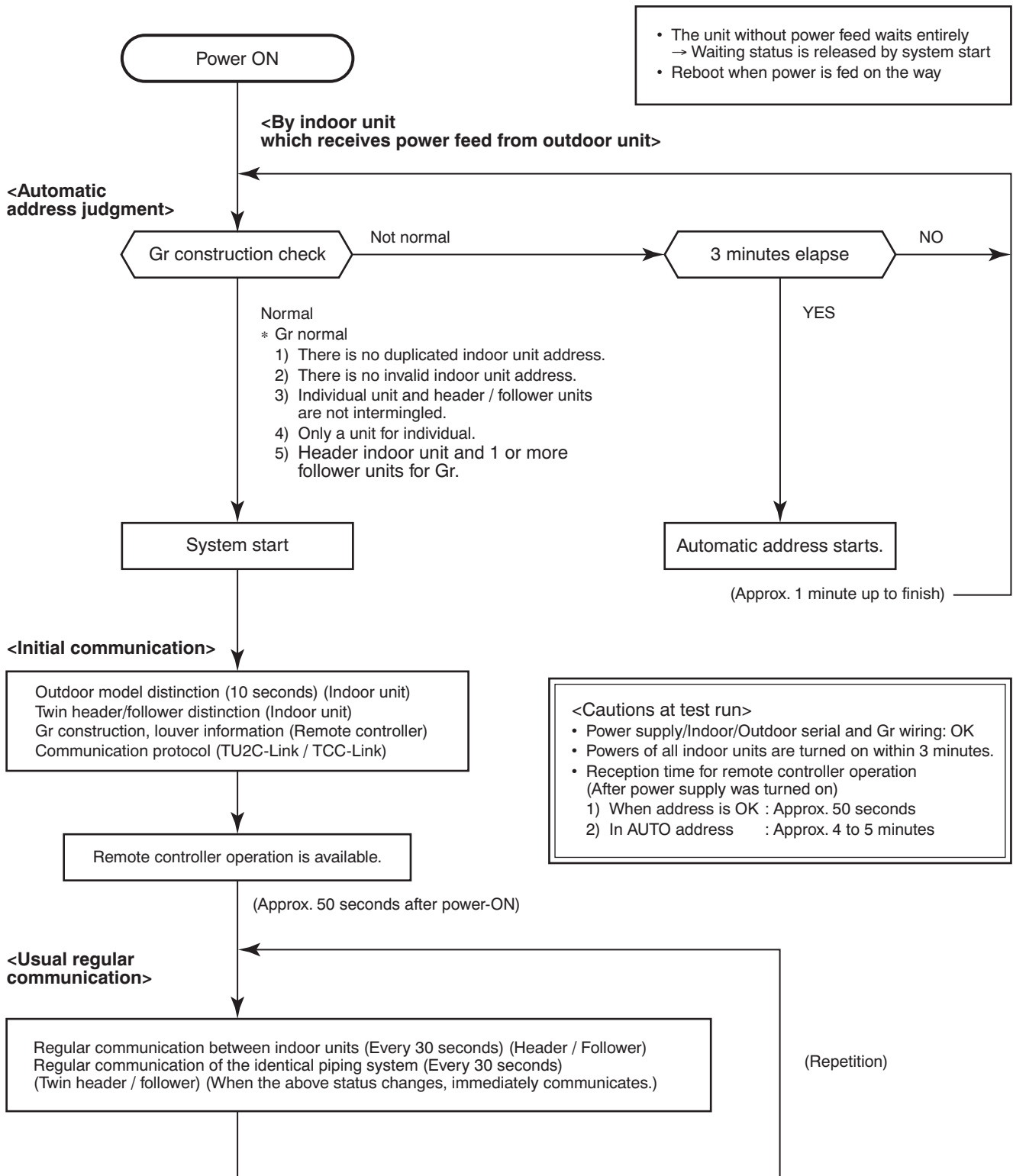

- In a group operation, if the indoor unit which was fed power after judgment of automatic address cannot receive regular communication from the header unit and regular communication on identical pipe within 120 seconds after power was turned on, it reboots (system reset).
 → The operation starts from judgment of automatic address (Gr construction check) again.
 (If the address of the header unit was determined in the previous time, the power fed to the header unit and reboot works, the header unit may change though the indoor unit line address is not changed.)

9-2. Setup at Local Site / Others

Model name: TCB-PCNT30TLE2

9-2-1. 1:1 Model Connection Interface (TCC-LINK adapter)

1. Function

This model is an optional P.C. board to connect the indoor unit to 1:1 model connection interface.
(Communication protocol: TU2C-Link or TCC-Link)

2. Microprocessor block diagram

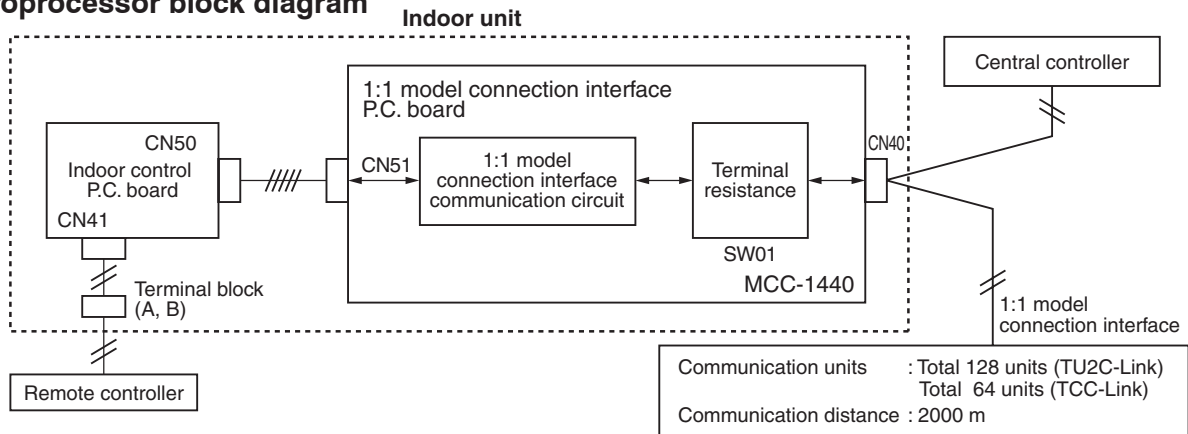

3. 1:1 model connection interface wiring connection

⚠ CAUTION

- 1) When controlling DI, SDI series collectively, 1:1 model connection interface (This option) is required.
- 2) In case of group operation, twin-triple operation, the 1:1 model connection interface is necessary to be connected to the header unit.
- 3) Connect the central control devices to the central control system wiring.
- 4) When controlling DI, SDI series only, turn on only Bit 1 of SW01 of the least line of the system address No. (OFF when shipped from the factory)
- 5) In the following cases, change the communication type to TCC-Link with the wired remote controller. Refer to 28 Communication type setting of 5-2. Control Specifications.
 - When performing group control in combination with the indoor unit dedicated to TCC-Link (other than RAV-HM*** series).
 - When connecting to the central control device dedicated to TCC-Link.

*** In case of DI, SDI series, the address is necessary to be set up again from the wired remote controller after automatic addressing.**

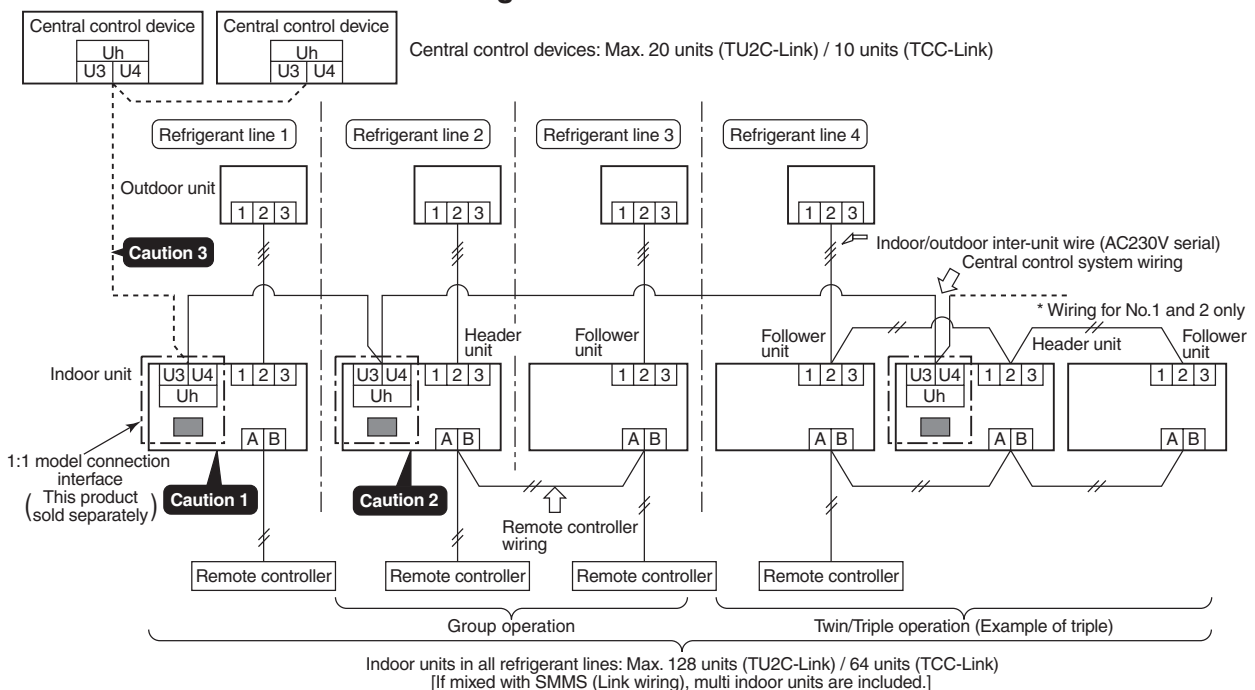

* However group follower units of SDI, DI series are not included in number of the units.

4. Wiring Specifications

- Use 2-core with no polar wire.
- Match the length of wire to wire length of the central control system. If mixed in the SMMS system, the wire length is lengthened with all indoor/outdoor inter-unit wire length at side.
- To prevent noise trouble, use 2-core shield wire.
- Connect the shield wire by closed-end connection and apply open process (insulating process) to the last terminal. Ground the earth wire to 1 point at indoor unit side. (In case of central controlling of digital inverter (DI, SDI) unit setup)

| No. of wires | Size |
|--------------|---|
| 2 | Up to 1000m: twisted wire 1.25mm ² Up to 2000m: twisted wire 2.0mm ² |

⚠ CAUTION

- 1) Closed-end connection of shield wire (Connect all the connecting parts of each indoor unit)
- 2) Apply open process to the last terminal (insulating process).
- 3) Ground earth wire to 1 point at indoor unit side.

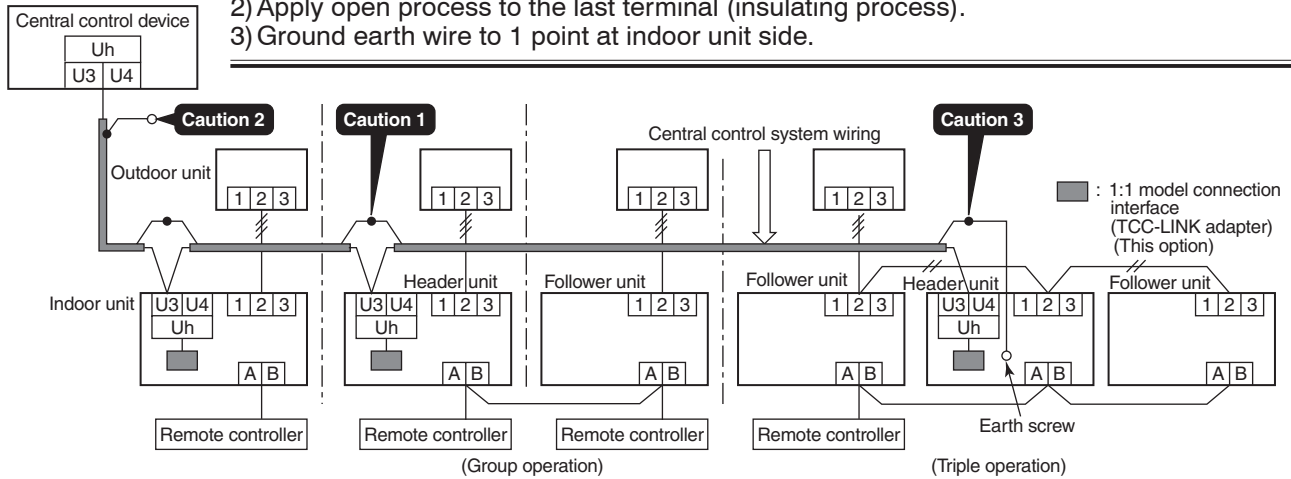

5. P.C. Board Switch (SW01) Setup

When performing collective control by customized setup only, the setup of terminator is necessary.

- Using SW01, set up the terminator.
- Set up the terminator to only the interface connected to the indoor unit of least line address No.

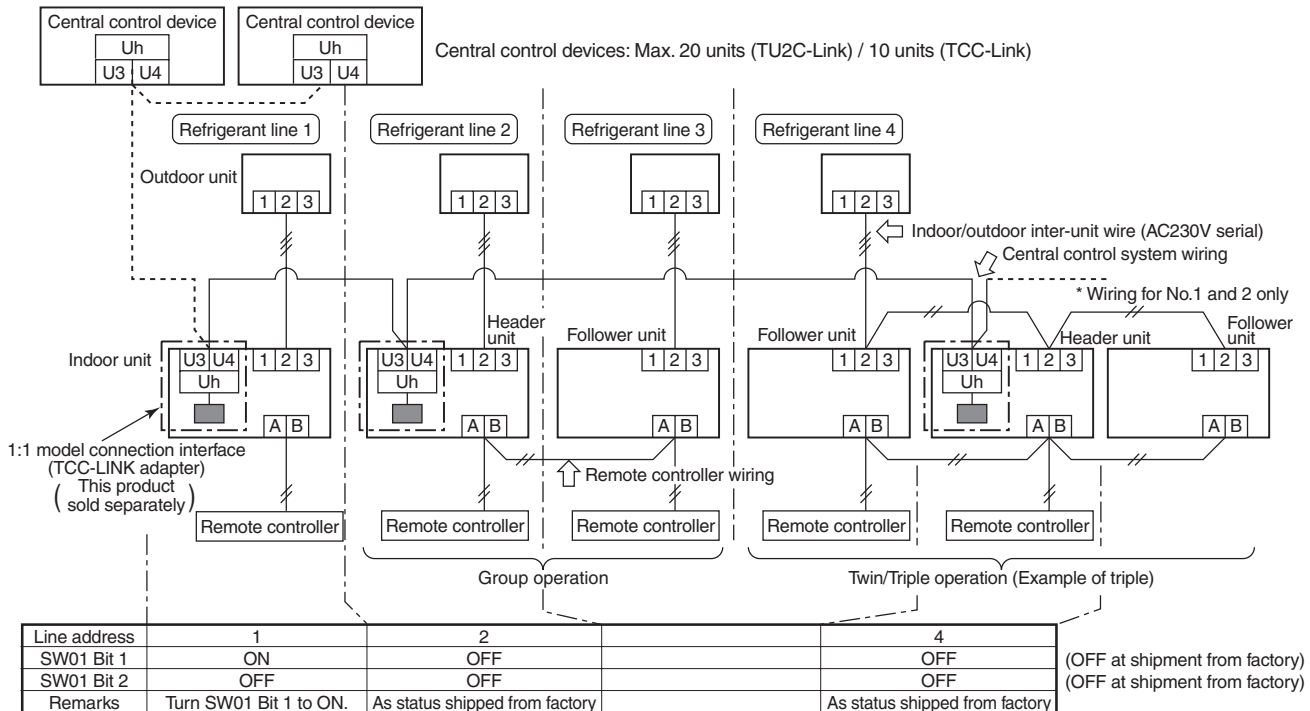

(Reference) Setup contents of switch

| SW01 | | Terminator | Remarks |
|-------|-------|------------|--|
| Bit 1 | Bit 1 | | |
| OFF | OFF | None | Mixed with SMMS (Link wiring) at shipment from factory |
| ON | OFF | 100Ω | Central control by digital inverter only |
| OFF | ON | 75Ω | Spare |
| ON | ON | 43Ω | Spare |

6. External view of P.C. board assembly

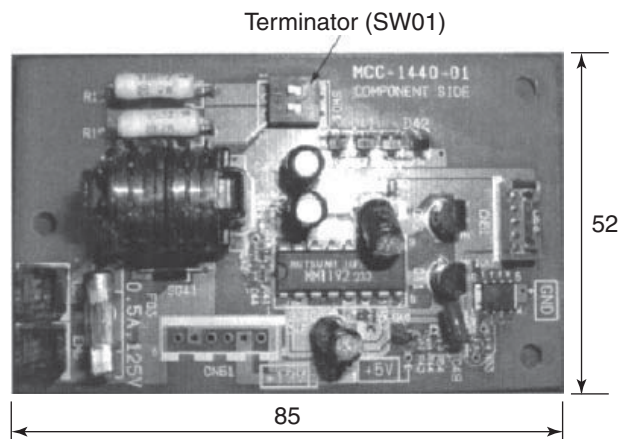

7. Address setup

In addition to set up the central control address, it is necessary to change the indoor unit number. (Line/Indoor/Group address). For details, refer to 1:1 model connection interface Installation Manual.

9-3. How to Set up Central Control Address Number

When connecting the indoor unit to the central control remote controller using 1:1 model connection interface, it is necessary to set up the central control address number.

- The central control address number is displayed as the line No. of the central control remote controller.

How to set up from indoor unit side by remote controller

<Procedure> Perform setup while the unit stops.

Set the following DN with the wired remote controller

| CODE No. (DN) | Irem | Description |
|------------------|----------------------------|---|
| 03 | Central contol address No. | 0001: No.1 to 0128: No.128 · · · TU2C-Link 0001: No.1 to 0164: No.64 · · · TCC-Link 00Un, 0099: Unset (Factory default) |

* Refer to 8-1-4. Function Selection Setup for how to operate the remote controller.

10. ADDRESS SETUP

10-1. Address Setup

<Address setup procedure>

When an outdoor unit and an indoor unit are connected and they are twin or when an outdoor unit is connected to each indoor unit respectively in the group operation even if multiple refrigerant lines are provided, the automatic address setup completes with power-ON of the outdoor unit. The operation of the remote controller is not accepted while automatic address works. (Approx. 4 to 5 minutes)

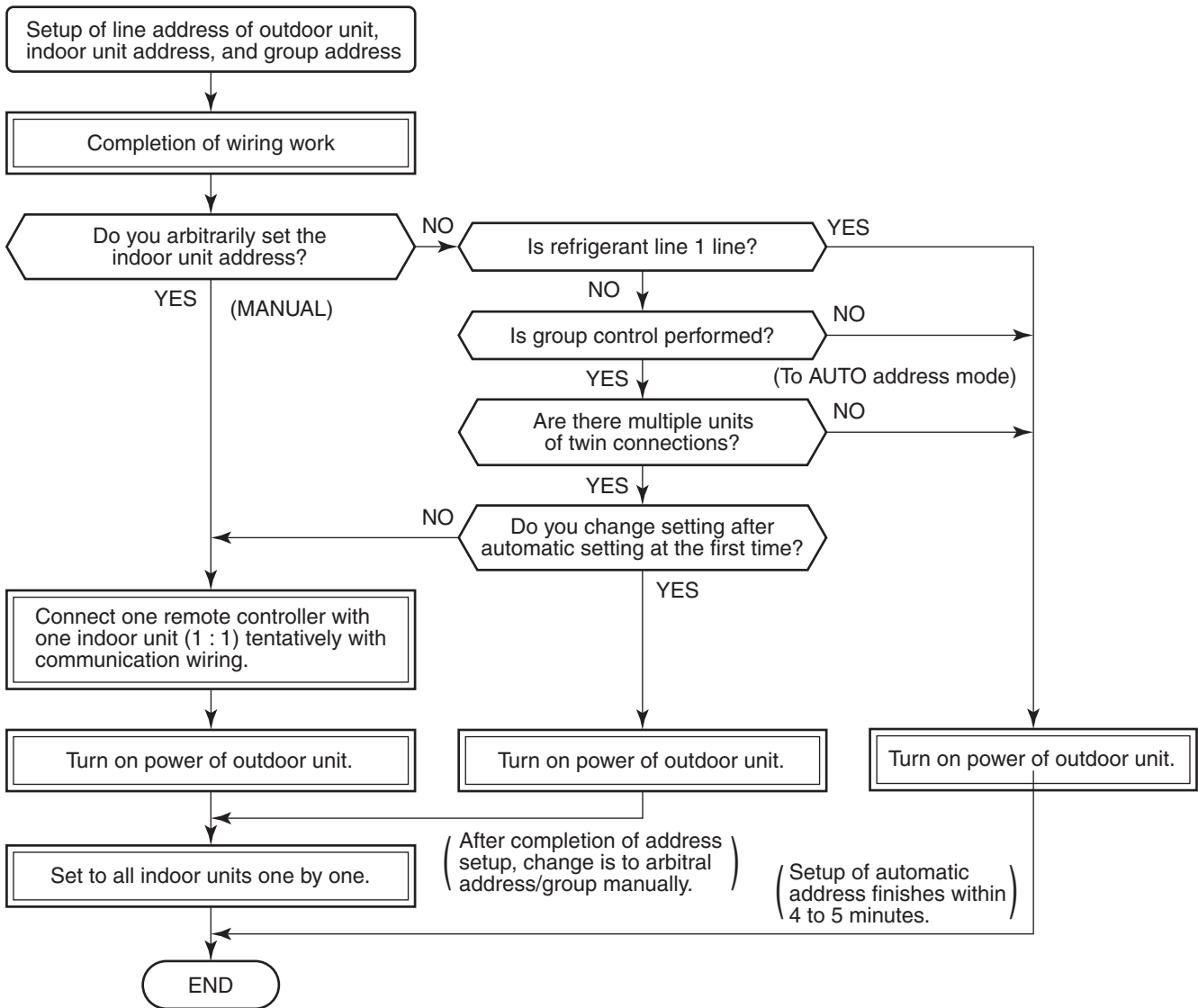

- When the following addresses are not stored in the neutral memory (IC10) on the indoor P.C. board, a test run operation cannot be performed. (Unfixed data at shipment from factory)

| | CODE No. | Data at shipment | SET DATA range |
|---------------------|----------|------------------|--|
| Line address | 12 | 00Un or 0099 | 0001 (No.1 unit) to 0128 (No.128 unit) ... TU2C-Link 0001 (No.1 unit) to 0030 (No.30 unit) ... TCC-Link |
| Indoor unit address | 13 | 00Un or 0099 | 0001 (No.1 unit) to 0128 (No.128 unit) ... TU2C-Link 0001 (No.1 unit) to 0064 (No.64 unit) ... TCC-Link |
| Group address | 14 | 00Un or 0099 | 0000 : Individual (Indoor units which are not controlled in a group) 0001 : Header unit (1 indoor unit in group control) 0002 : Follower unit (Indoor units other than header unit in group control) |

10-2. Address Setup & Group Control

<Terminology>

- Indoor unit No. : N – n = Outdoor unit line address N – Indoor unit address n
- Group address : 0 = Single (Not group control)
1 = Header unit in group control
2 = Follower unit in group control
- Header unit (= 1) : The representative of multiple indoor units in group operation sends/receives signals to/from the remote controllers and follower indoor units.
(*It has no relation with an indoor unit which communicates serially with the outdoor units.)
The operation mode and setup temperature range are displayed on the remote controller LCD. (Except air direction adjustment of louver)
- Follower unit (= 2) : Indoor units other than header unit in group operation
Basically, follower units do not send/receive signals to/from the remote controllers.
(Except trouble and response to demand of service data)
- Master unit (Representative unit) (Header Twin) : This unit communicates with the indoor unit (sub) which serial-communicates with the outdoor units and sends/receives signal (Command from compressor) to/from the outdoor units as the representative of the cycle control in the indoor units of the identical line address within the minimum unit which configures one of the refrigerating cycles of Twin.
- Sub unit (Subordinate unit) (Follower Twin) : Indoor units excluding the header unit in Twin
This unit communicates with (Header) indoor unit in the identical line address and performs control synchronized with (Header) indoor unit.
This unit does not perform the signal send/receive operation with the outdoor units.:
N judgment for serial signal trouble.

10-2-1. System configuration

1. Single

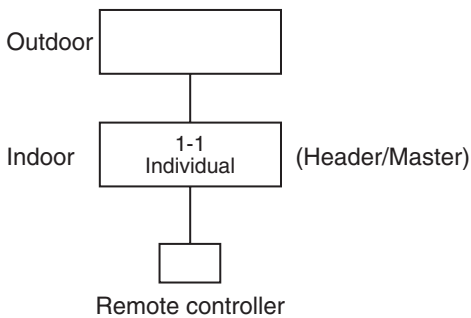

2. Twin

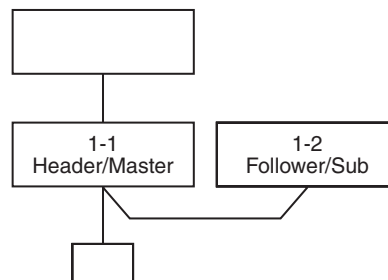

3. Single group operation

- Each indoor unit controls the outdoor unit individually.

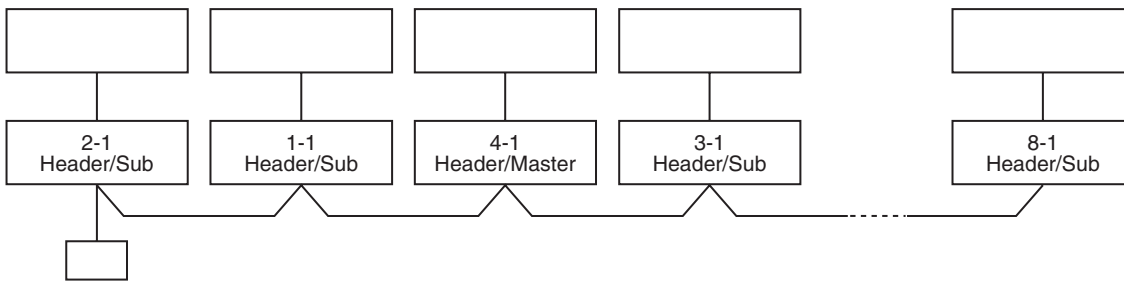

4. Multiple groups operation (Manual address setting)

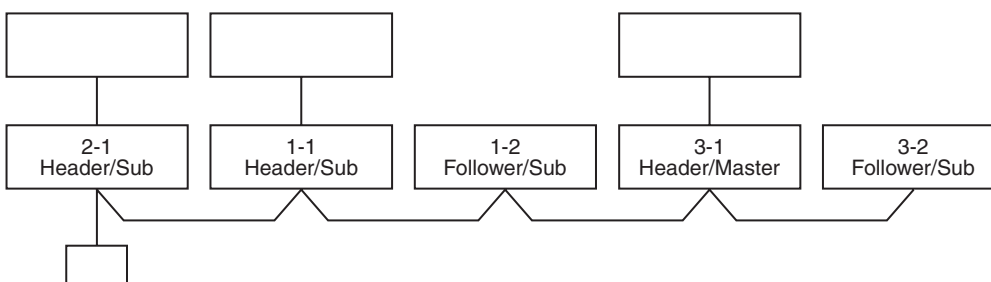

- Master unit: The master unit receives the indoor unit data (thermostat status) of the sub (Without identical line address & indoor/outdoor serial) and then finally controls the outdoor compressor matching with its own thermostat status. The master unit sends this command information to the sub unit.
- Sub unit: The sub unit receives the indoor unit data from the master (With identical line address & indoor/outdoor serial) and then performs the thermostat operation synchronized with the master unit. The sub unit sends own thermostat ON/OFF demand to the master unit.

(Example)

No. 1-1 master unit sends/receives signal to/from No. 1-2 and No. 1-3 sub units.
(It is not influenced by the line 2 or 3 address indoor unit.)

10-2-2. Automatic Address Example from Unset Address (No miswiring)

1. Standard (One outdoor unit)

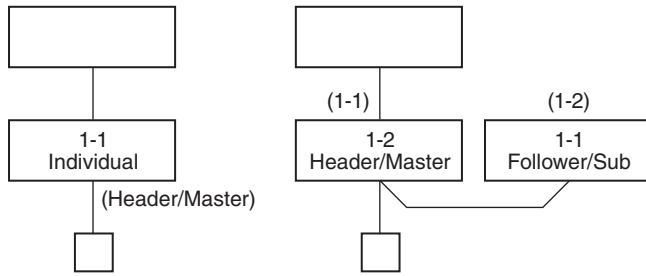

Only turning on source power supply (Automatic completion)

2. Group operation

(Multiple outdoor units = Multiple indoor units with serial communication only, without twin)

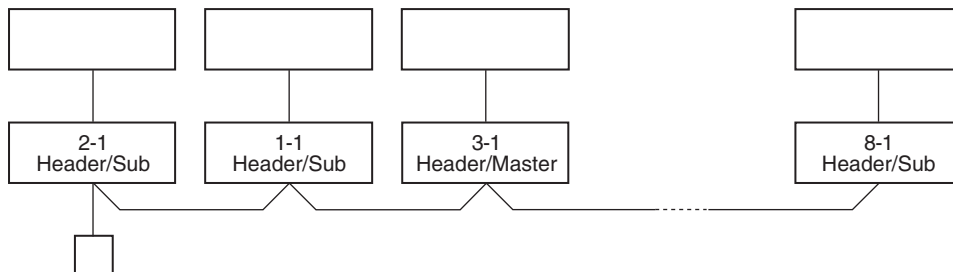

Only turning on source power supply (Automatic completion)

3. Multiple groups operation

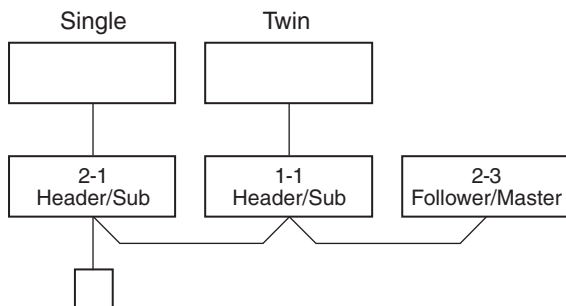

**Change is necessary
Manually change addresses of the multiple sub units
simultaneously from the remote controller.**

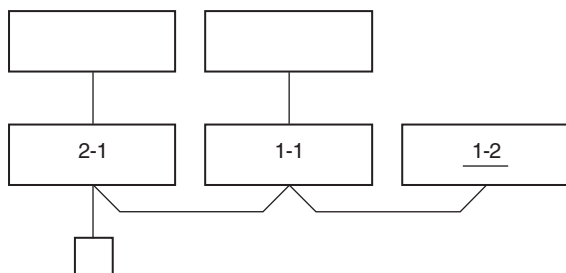

10-3. Address Setup (Manual Setting from Remote Controller)

In case that addresses of the indoor units will be determined prior to piping work after wiring work

- Set an indoor unit per a remote controller.
- Turn on power supply.

| CODE No. (DN) | Item | Description |
|---------------|---------------------|--|
| 12 | Line address | 0001: No.1 to 0128: No.128 ... TU2C-Link 0001: No.1 to 0030: No.30 ... TCC-Link |
| 13 | Indoor unit address | 0001: No.1 to 0128: No.128 ... TU2C-Link 0001: No.1 to 0030: No.30 ... TCC-Link |
| 14 | Group address | 0000: Individual 0001: Header unit 0002: Follower unit |

(Example of 2-lines wiring)
(Solid line: Wiring, Broken line: Refrigerant pipe)

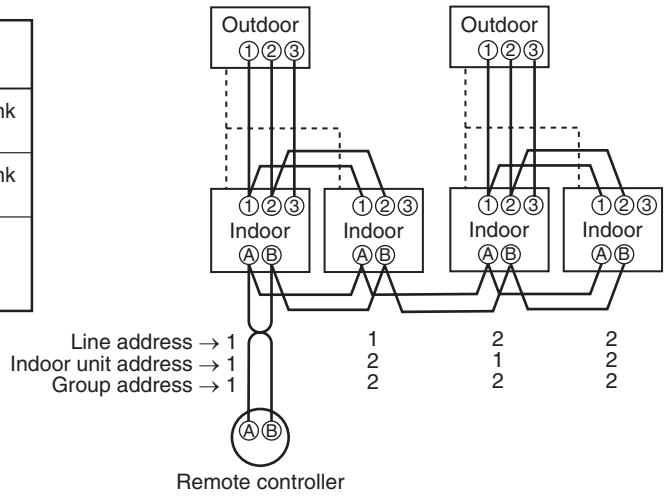

For the above example, perform setting by connecting singly the wired remote controller without remote controller inter-unit wire.

<RBC-ASCU1*>

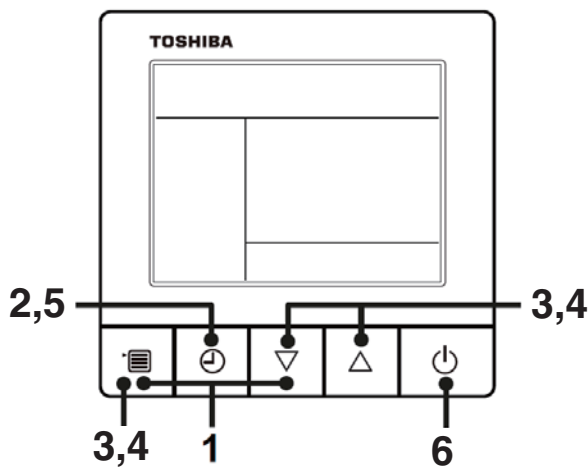

2

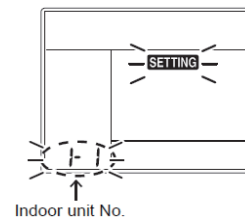

3,4

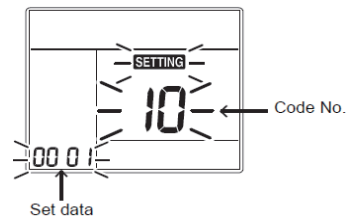

- 1 Push and hold the [menu + ▽] buttons at same time for more than 10 seconds.
- 2 Push the [OFF timer] button to confirm the selected indoor unit.

<Line address>

- 3 Push the [menu] button until the CODE No. flashes. And using the [▽ or △] buttons, specify the CODE No.12.
- 4 Push the [menu] button until the SET DATA flashes. And using the [▽ or △] buttons, set a system address.
- 5 Push the [OFF timer] button to confirm the SET DATA.

<Indoor unit address>

- 6** Push the [menu] button until the CODE No. flashes. And using the [▽ or △] buttons, specify the CODE No.13.
- 7** Push the [menu] button until the SET DATA flashes. And using the [▽ or △] buttons, set an indoor unit address.
- 8** Push the [OFF timer] button to confirm the SET DATA.

<Group address>

- 9** Push the [menu] button until the CODE No. flashes. And using the [▽ or △] buttons, specify the CODE No.14.
- 10** Push the [menu] button until the SET DATA flashes. And using the [▽ or △] buttons, set a group address.
If the indoor unit is individual, set the address to 0000. (header unit : 0001, follower unit : 0002)
Individual :0000
Header unit :0001 } In case of group control
Follower unit :0002 }

- 11** Push the [OFF timer] button to confirm the SET DATA.
- 12** When all the settings have been completed, push the [ON/OFF] button to return to normal mode.

MAINTENANCE / CHECK LIST

Aiming in environmental preservation, it is strictly recommended to clean and maintain the indoor/outdoor units of the operating air conditioning system regularly to secure effective operation of the air conditioner.

It is also recommended to maintain the units once a year regularly when operating the air conditioner for a long time.

Check periodically signs of rust or scratches, etc. on coating of the outdoor units.

Repair the trouble position or apply the rust resisting paint if necessary.

If an indoor unit operates for approx. 8 hours or more per day, usually it is necessary to clean the indoor/outdoor units once three months at least.

These cleaning and maintenance should be carried out by a qualified dealer.

Although the customer has to pay the charge for the maintenance, the life of the unit can be prolonged.

Failure to clean the indoor/outdoor units regularly will cause shortage of capacity, freezing, water leakage or trouble on the compressor.

| Part name | Object | | Contents of check | Contents of maintenance |
|------------------------------|--------|---------|---|--|
| | Indoor | Outdoor | | |
| Heat exchanger | ✓ | ✓ | • Blocking with dust, damage check | • Clean it when blocking is found. |
| Fan motor | ✓ | ✓ | • Audibility for sound | • When abnormal sound is heard |
| Filter | ✓ | — | • Visual check for dirt and breakage | • Clean with water if dirty • Replace if any breakage |
| Fan | ✓ | ✓ | • Visual check for swing and balance • Check adhesion of dust and external appearance. | • Replace fan when swinging or balance is remarkably poor. • If a large dust adheres, clean it with brush or water. |
| Suction/ Discharge grille | ✓ | — | • Visual check for dirt and scratch | • Repair or replace it if deformation or damage is found. |
| Drain pan | ✓ | — | • Check blocking by dust and dirt of drain water. | • Clean drain pan, Inclination check |
| Face panel, Louver | ✓ | — | • Check dirt and scratch. | • Cleaning/Coating with repair painting |
| External appearance | — | ✓ | • Check rust and peeling of insulator • Check peeling and floating of coating film | • Coating with repair painting |

11. DETACHMENTS

⚠ WARNING

Be sure to stop operation of the air conditioner before work and then turn off switch of the breaker.

⚠ CAUTION

Be sure to put on gloves during working time; otherwise an injury will be caused by a part, etc.

NOTE

In a section 10, Detachments, the models are expressed as follows for convenience.

56 Types: RAV-HM561BTP-E, -TR

80 Types: RAV-HM801BTP-E, -TR

90 Types: RAV-HM901BTP-E

110 Types: RAV-HM1101BTP-E, -TR

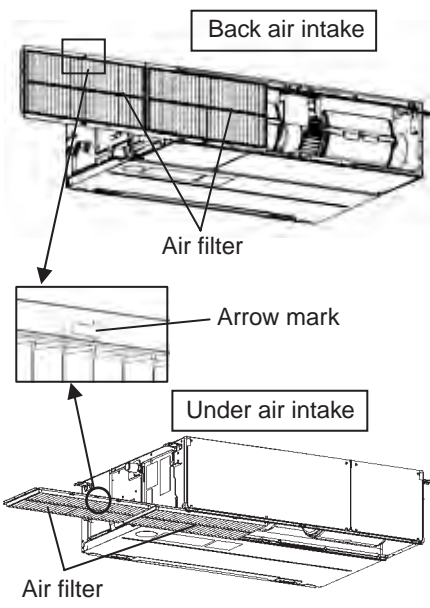

140 Types: RAV-HM1401BTP-E, -TR

160 Types: RAV-HM1601BTP-E, -TR

| No. | Part name | Procedure | Remarks |
|-----|------------|---|--|
| ① | Air filter | <p>1. Detachment</p> <p>1) Slide the filter toward the opposite side of the arrow mark and then pull out the filter. (In the case that two filters are provided, pull out the first filter, then the second filter will be pulled out connected with the first filter.)</p> <p>2. Attachment</p> <p>1) Insert the filter in the filter rail toward the arrow mark, slide it until the filter stops and then fix it. (In the case that two filters are provided, insert the second filter in the same direction after inserting the first filter.)</p> |  <p>The diagram illustrates the process of removing and installing air filters. The top portion shows the 'Back air intake' section of the unit with an 'Air filter' being pulled out. The bottom portion shows the 'Under air intake' section with an 'Air filter' being inserted into the 'Air filter' rail. An 'Arrow mark' is shown on the rail to indicate the correct insertion direction.</p> |

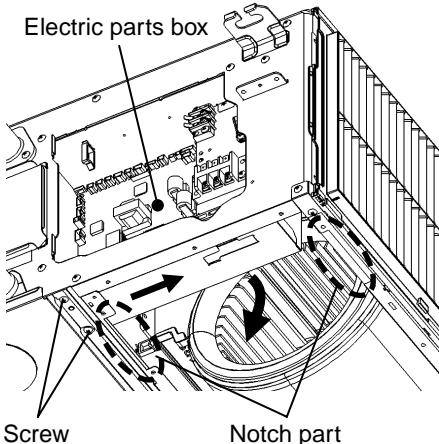
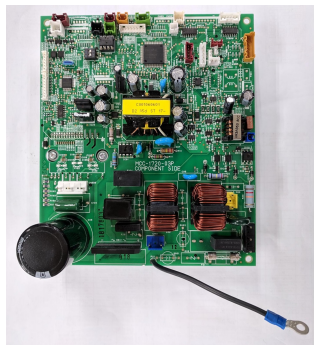
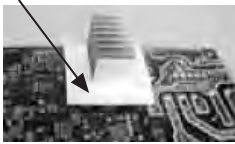
| No. | Part name | Procedure | Remarks |
|---|--------------------------|--|--|
| ② | Suction panel | <p>1. Detachment</p> <ol style="list-style-type: none"> 1) Remove the fixing screws A which fix the suction panel. Loosen the fixing screws B. 2) Slide the suction panel to the arrow side and then remove the panel. <p>2. Attachment</p> <ol style="list-style-type: none"> 1) Hook the suction panel to the fixing screws B and tighten screws. 2) Attach the removed screws A to the original positions. | |
| <p>The diagrams illustrate the process for three models: 56 Type, 80 Type, and 90~160 Type. For 'Under air intake', the suction panel is shown being lifted away from the unit by removing screws A and loosening screws B. For 'Back air intake', the suction panel is shown being pushed back into the unit and secured by screws B, with screws A being re-attached to their original positions.</p> | | | |
| ③ | Electric parts box cover | <p>1. Detachment</p> <ol style="list-style-type: none"> 1) Remove the screw A of the electric parts box cover to loosen screw B. 2) As shown in the right figure, when sliding it toward arrow direction and pulling to this side, the electric parts cover opens using the hinge part as a shaft. 3) Take off the slit of the electric parts box cover from the projection of the side plate and then remove the cover. <p>2. Attachment</p> <ol style="list-style-type: none"> 1) Hook the slit of the electric parts box cover to the projection of the side plate, close the cover, enter screw B in the Key hole and then slide it. 2) Fix the electric parts box cover by tightening with screws A and B. | <p>The diagram shows a side view of the electric parts box cover. For detachment, the cover is slid towards the right and pulled down, separating the slit from the projection on the side plate. For attachment, the cover is pushed back up and to the left, hooking the slit onto the projection. The cover is then secured by tightening screw A and screw B, which passes through a key hole.</p> |

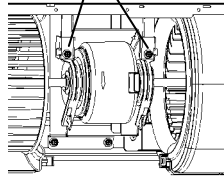
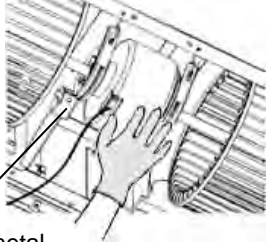
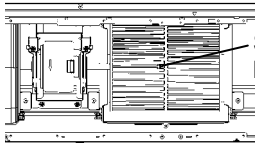
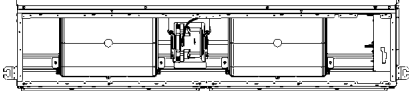
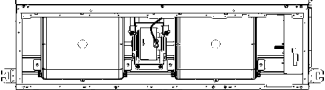
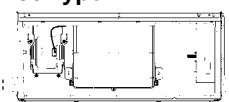
| No. | Part name | Procedure | Remarks |
|-----|--------------------|---|---|
| ④ | Electric parts box | <p>1. Detachment</p> <ol style="list-style-type: none"> 1) Perform works of 1 of ①. (In case of under air intake) Perform works of 1 of ②. (In case of back air intake) Perform works of 1 of ③. 2) Remove the indoor/outdoor connecting wire and remote controller wire from each terminal block. 3) Remove the connectors which connected from the control P.C. board to other parts. <p>NOTE</p> <hr/> <p>First unlock the housing and then remove the connectors.</p> <hr/> <p>CN34 : Float switch (3P, Red) CN41 : Remote controller terminal block (3P, Blue) (Screw part of terminal block, 2P.) CN504 : Drain pump (2P, White) CN67 : Power supply terminal block (5P: Black) (Screw part of terminal block, 3P.) CN101 : TC sensor (2P: Black) CN102 : TCJ sensor (2P, Red) CN104 : Room temperature (2P, Yellow)</p> <ol style="list-style-type: none"> 4) Remove screws. (Ø4 x 10, 2 pcs.) 5) Slide the electric parts box toward the arrow mark and then remove the box from the bottom side of the main unit. <p>2. Attachment</p> <ol style="list-style-type: none"> 1) Attach the electric parts box and then perform wiring as original. <p>Notes 1</p> <hr/> <p>Check there is no missing or contact failure on the connectors.</p> <hr/> <p>Notes 2</p> <hr/> <p>Be sure to perform wiring as original.</p> <hr/> <ol style="list-style-type: none"> 2) Attach air filter, suction panel, and electric parts box as original. |   |
| ⑤ | Control P.C. board | <p>1. Detachment</p> <ol style="list-style-type: none"> 1) Perform work of 1 of ④. (In the works of 1 of ④, removal of the control P.C. board is available even if you do not perform works after 4)). 2) Unlock the card edge spacers (5 positions) in the electric parts box to remove the control P.C. board. <p>2. Attachment</p> <ol style="list-style-type: none"> 1) Mount control P.C. board in the electric parts box as original. 2) Attach the electric parts box as original. 3) Be sure to perform wiring as original in the electric parts box. <p>NOTE</p> <hr/> <p>Check there is no missing or contact failure on the connectors.</p> <hr/> <ol style="list-style-type: none"> 4) Attach each air filter, suction panel or electric parts box cover as original. |  <p>⚠ CAUTION When replacing PC. board, check no-mex paper is attached.</p>  |

| No. | Part name | Procedure | Remarks |
|-----|--------------------------------|---|--|
| ⑥ | Fan motor, Fan, Fan case | <p>1. Detachment</p> <ol style="list-style-type: none"> 1) Perform works until opening of the electric parts box cover in works of 1 of ④. 2) Remove connectors for fan motor wiring from control P.C. board. CN333 : Motor power supply (5P: White) 3) Open the fan case (under) and remove it while pressing claws of the fan case (under). (There are both sides of the case) 4) Remove the fixing screws (Ø5 x 10, 2 pcs.) of the fixing plate (2 pcs.) at the side of the fan motor. (The fan motor becomes temporal hanging status by fixing plate.) 5) While supporting the fan motor by hands, remove the fixing plate from the motor base to remove the fan motor. 6) Loosen the hexagonal screw hole of the fan and then pull out the fan from the shaft. (Hexagon wrench : 3mm) <p>2. Attachment</p> <ol style="list-style-type: none"> 1) Insert the fan in the shaft while adjusting to match the hexagonal screw hole to the groove of the shaft. 2) Perform screwing the fan motor with the fixing plate (Ø5 x 10, 2 pcs.) <p>NOTE</p> <hr/> <p>Match the fan motor with turning direction of the fan and fix so that the 56 type and 80 type fan motor wirings are at refrigerant piping side and 90~160 type is at opposite side of refrigerant piping.</p> <hr/> <ol style="list-style-type: none"> 3) While positioning so that the fan is at the center of the fan case (upper), fix the fan with hexagonal screw. <p>NOTE</p> <hr/> <p>Be sure to use a torque wrench for fixing and tighten with 4.9N•m or more.</p> <hr/> <ol style="list-style-type: none"> 4) Attach the fan case (under) as original and check the fan turns smoothly without coming to contact with the fan case. 5) Connect the fan motor wirings as before, close and fix the electric parts box cover. Be sure to perform wirings as original in the electric parts box. 6) Attach air filter and suction panel as original position. | <p>Fan motor wiring CN333</p>  <p>Fixing screw</p>   <p>Fixing sheet metal</p>  <p>Screw with hexagonal hole</p> <p>90~160 Type</p>  <p>80 Type</p>  <p>56 Type</p>  <div style="border: 1px solid black; padding: 2px; display: inline-block;">Refrigerant piping side</div>  <p>⚠ CAUTION When replacing the fan motor, be sure to exchange the clamp filter with the fan motor lead wire.</p> |

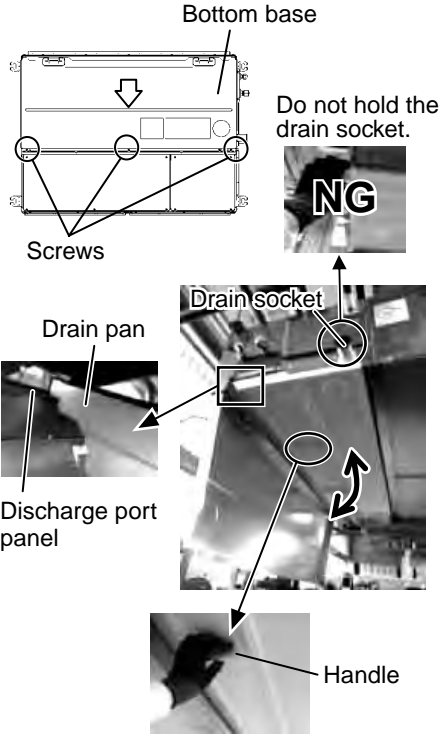
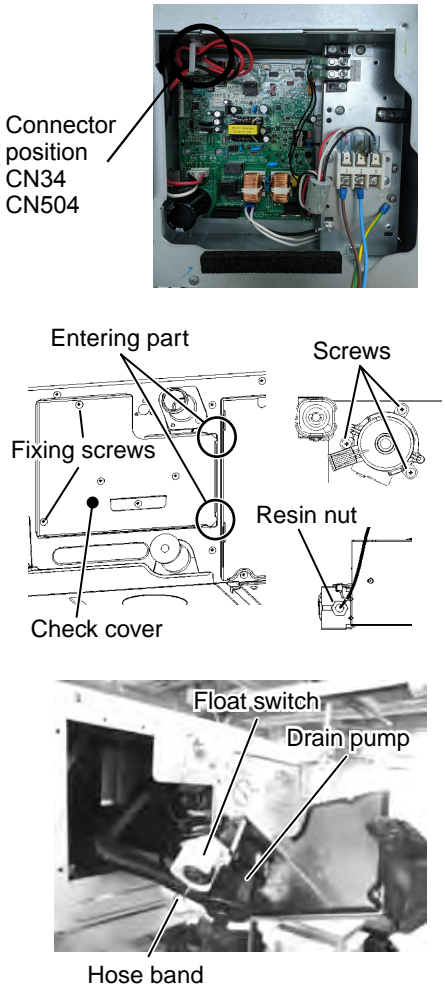
| No. | Part name | Procedure | Remarks |
|-----|----------------------------|--|--|
| ⑦ | Drain pan | <p>1. Detachment</p> <p>1) Remove the drain cap and then extract the drain water accumulated in the drain pan.</p> <p>NOTE</p> <p>When removing the drain cap, be sure to receive drain water using a bucket, etc.</p> <p>2) Loosen screws which fix the bottom base. (3 positions) (For 140 type models, remove 2 screws at the center.)</p> <p>3) As shown in the right figure, when sliding it toward arrow direction, the electric parts cover the bottom base opens using the hinge part as a shaft.</p> <p>4) Hold handle of the drain pan and then pull off slowly.</p> <p>CAUTION</p> <p>When removing the drain pan, do not hold the drain socket. (Water leakage may be caused.)</p> <p>2. Attachment</p> <p>1) First hook the thin side of the drain pan to the discharge panel and then push in the thick side.</p> <p>2) Close the bottom base and fix it with screws.</p> |  <p>Bottom base</p> <p>Do not hold the drain socket.</p> <p>NG</p> <p>Screws</p> <p>Drain pan</p> <p>Discharge port panel</p> <p>Drain socket</p> <p>Handle</p> |
| ⑧ | Drain pump Float switch | <p>1. Detachment</p> <p>1) Perform works until opening of the electric parts box cover in works of 1 of ④.</p> <p>2) Remove the connectors which connect to float switch of the drain pump from the control P.C. board. CN34 : Float switch (3P, Red) CN504 : Drain pump (2P, White)</p> <p>3) Remove the fixing screws (2 positions) of the check cover and then take out the check cover. (To the check cover, the drain pump and float switch are attached.)</p> <p>4) Pick up the hose band, shift from the pump connecting part, remove the drain hose and then remove the check cover.</p> <p>5) Remove screws which fix the drain pump assembly and then remove the drain pump assembly. (Ø4 x 10, 3 pcs.)</p> <p>6) Remove the resin nut switch and then remove the float switch from the fixing plate.</p> <p>2. Attachment</p> <p>1) Using the removed screws, fix the drain pump assembly as original.</p> <p>2) Using the removed resin nut, fix the float switch as original.</p> <p>3) Connect the drain hose as original and then attach the hose band.</p> <p>4) Connect the drain pump and the float switch wiring as original and close the electric parts box cover for fixing. Be sure to perform wiring in the electric parts box as original.</p> <p>5) Enter the corners (2 positions) of the check cover in the entering part and then fix it using fixing screws (2 positions).</p> |  <p>Connector position CN34 CN504</p> <p>Entering part</p> <p>Screws</p> <p>Fixing screws</p> <p>Resin nut</p> <p>Check cover</p> <p>Float switch</p> <p>Drain pump</p> <p>Hose band</p> |

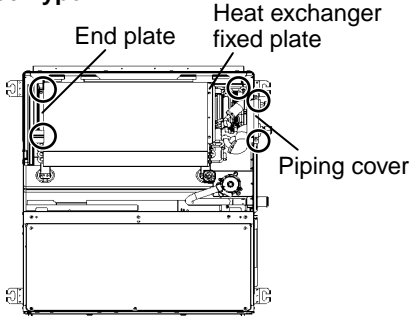
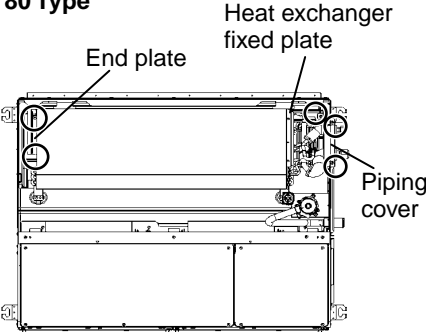
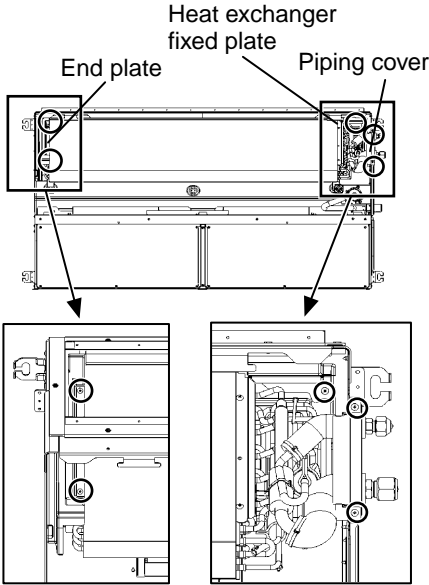
| No. | Part name | Procedure | Remarks |
|-----|----------------|--|--|
| ⑨ | Heat exchanger | <p>1. Detachment</p> <ol style="list-style-type: none"> 1) Recover the refrigerant gas and then remove the refrigerant pipe of the indoor unit. 2) Perform works of 1 of ⑦. 3) Pull out TC sensor and TCJ sensor wirings from the holder. 4) Remove the screws (Ø4 x 8, 2 pcs.) and then remove the piping cover. 5) Remove screws (Ø4 x 8, 1pc.) of the heat exchanger fixed plate. 6) While holding the heat exchanger, remove the fixed screws (Ø4 x 8, 2 pcs.) of the end plate and then take out the heat exchanger slowly. <p>2. Attachment</p> <ol style="list-style-type: none"> 1) Set the heat exchanger at the original position and fix it as before, using screws which removed the end plate, heat exchanger fixed plate and piping cover. 2) Enter TC sensor and TCJ sensor wirings in the holder and then perform wirings as original. 3) Attach the drain pan and the bottom base as original. | <p>○ : Screw position</p> <p>56 Type</p>  <p>80 Type</p>  <p>90~160 Type</p>  |

12. EXPLODED VIEWS AND PARTS LIST

12-1. Indoor Unit

RAV-HM561BTP-E(TR)

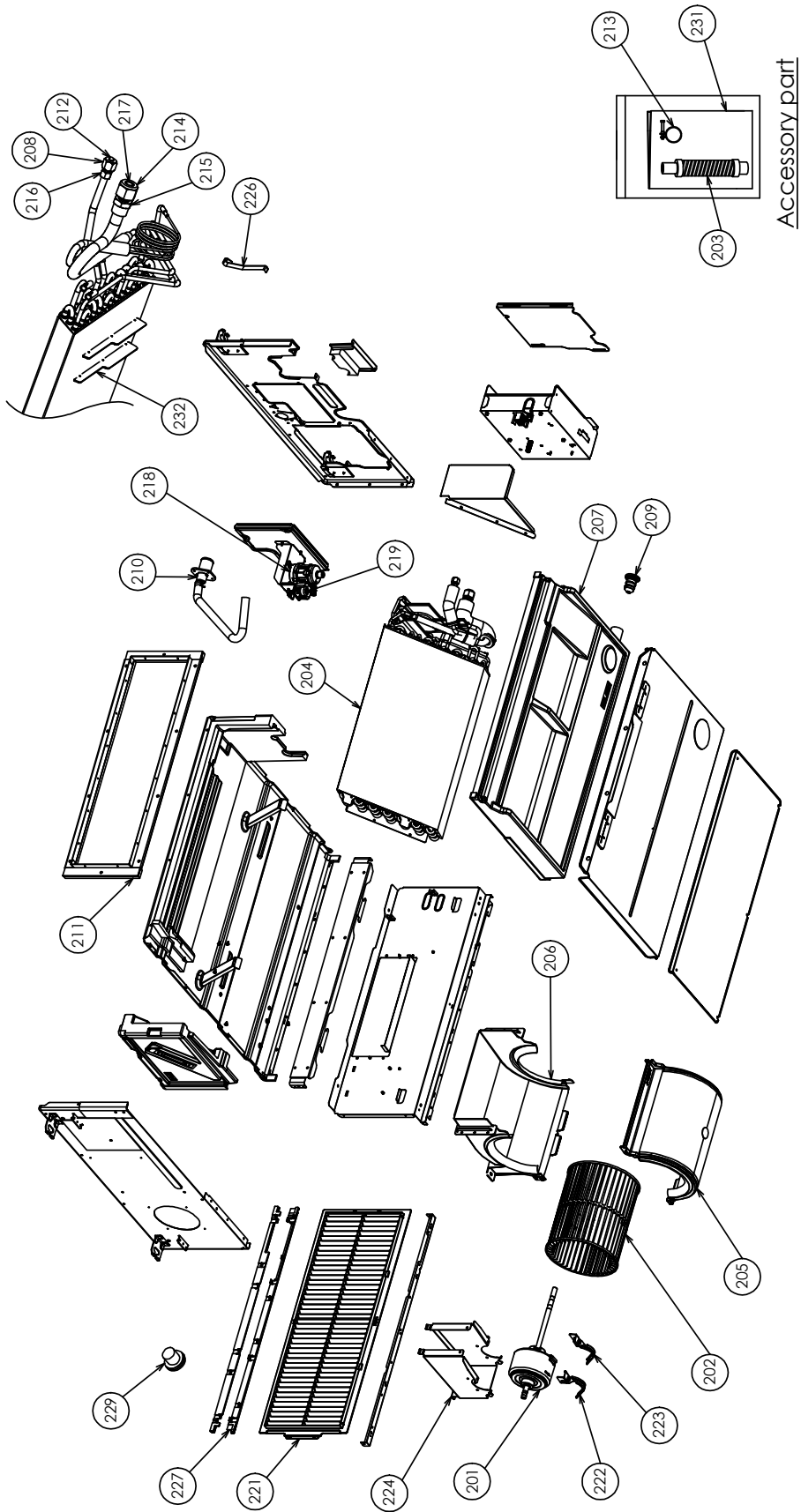

| Location No. | Part No. | Description | Model name | |
|--------------|----------|----------------------------|----------------|-----------------|
| | | | RAV-HM561BTP-E | RAV-HM561BTP-TR |
| 201 | 43T21448 | MOTOR, FAN | 1 | 1 |
| 202 | 43T20340 | FAN, MULTI BLADE | 1 | 1 |
| 203 | 43T70315 | HOSE, DRAIN | 1 | 1 |
| 204 | 43T44615 | REFRIGERANT CYCLE ASSEMBLY | 1 | 1 |
| 205 | 43T22335 | CASE, FAN, LOWER | 1 | 1 |
| 206 | 43T22337 | CASE, FAN, UPPER | 1 | 1 |
| 207 | 43T72317 | PAN ASSY, DRAIN | 1 | 1 |
| 208 | 43T82336 | SOCKET | 1 | 1 |
| 209 | 43T79321 | CAP, DRAIN | 1 | 1 |
| 210 | 43T70319 | ASM-HOSE-DRAIN | 1 | 1 |
| 211 | 43T39356 | FLANGE | 1 | 1 |
| 212 | 43T47331 | BONNET, 6.35 DIA | 1 | 1 |
| 213 | 43T83311 | BAND, HOSE | 1 | 1 |
| 214 | 43T82338 | SOCKET | 1 | 1 |
| 215 | 43T97322 | NUT, FLARE, 1/2 IN | 1 | 1 |
| 216 | 43T97320 | NUT, FLARE, 1/4 IN | 1 | 1 |
| 217 | 43T47333 | BONNET, 12.70 DIA | 1 | 1 |
| 218 | 43T77301 | PUMP ASSY | 1 | 1 |
| 219 | 43T51312 | SWITCH, FLOAT | 1 | 1 |
| 221 | 43T80340 | AIR FILTER | 1 | 1 |
| 222 | 43T39415 | BAND-MOTOR-R | 1 | 1 |
| 223 | 43T39416 | BAND-MOTOR-L | 1 | 1 |
| 224 | 43T39417 | BASE-MOTOR | 1 | 1 |
| 226 | 43T19333 | HOLDER, SENSOR | 2 | 2 |
| 227 | 43T82329 | RAIL, FILTER ASSY | 1 | 1 |
| 229 | 43T82323 | FILTER, STOPPER | 1 | 1 |
| 231 | 43T85879 | OWNER'S MANUAL | 1 | - |
| 231 | 43T85880 | OWNER'S MANUAL | - | 1 |
| 232 | 43T39352 | PLATE,WIND | 2 | 2 |

RAV-HM801BTP-E(TR)

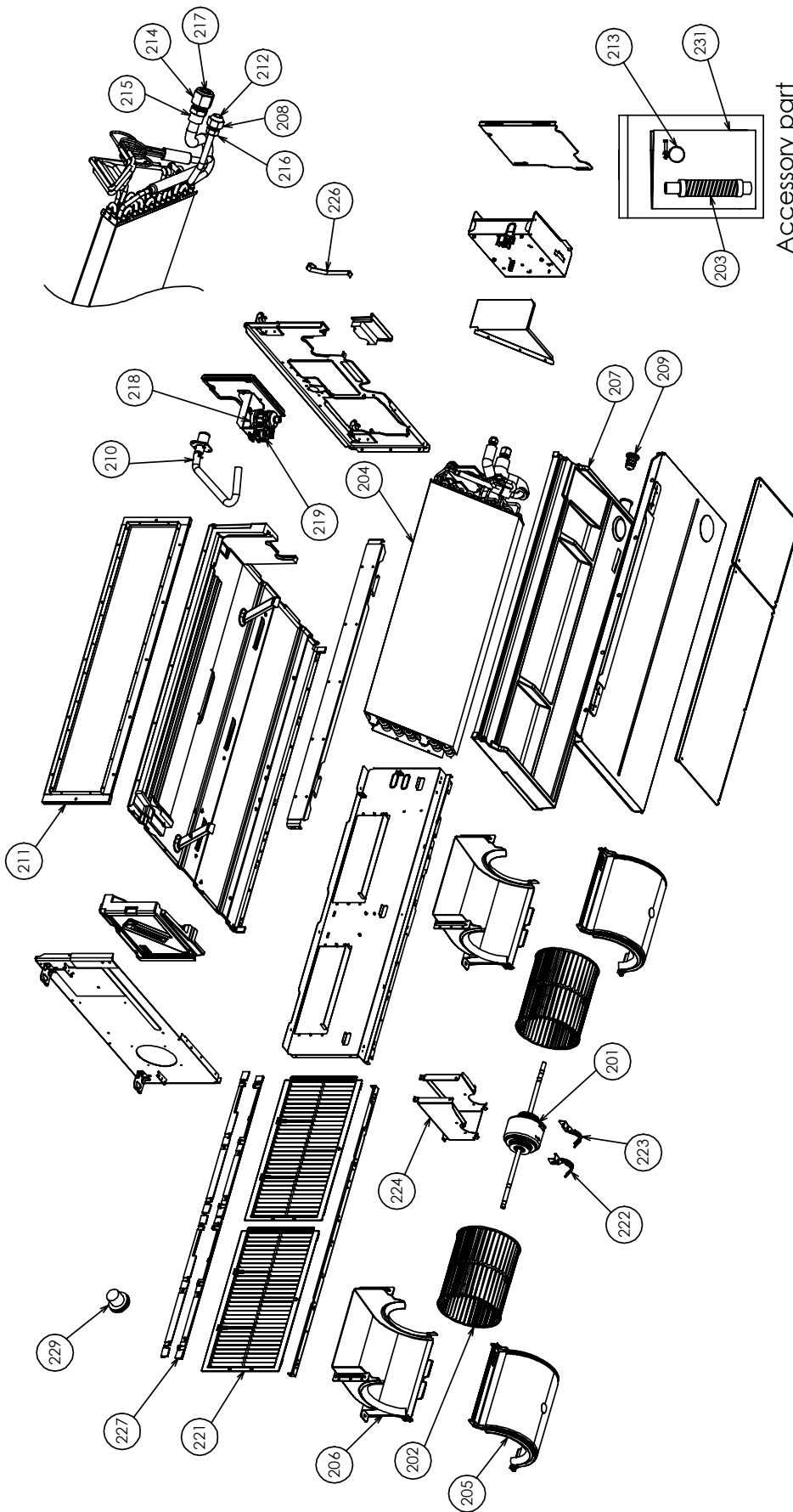

| Location No. | Part No. | Description | Model name | |
|--------------|----------|----------------------------|----------------|-----------------|
| | | | RAV-HM801BTP-E | RAV-HM801BTP-TR |
| 201 | 43T21447 | MOTOR, FAN | 1 | 1 |
| 202 | 43T20340 | FAN, MULTI BLADE | 2 | 2 |
| 203 | 43T70315 | HOSE, DRAIN | 1 | 1 |
| 204 | 43T44616 | REFRIGERANT CYCLE ASSEMBLY | 1 | 1 |
| 205 | 43T22335 | CASE, FAN, LOWER | 2 | 2 |
| 206 | 43T22337 | CASE, FAN, UPPER | 2 | 2 |
| 207 | 43T72318 | PAN ASSY, DRAIN | 1 | 1 |
| 208 | 43T82337 | SOCKET | 1 | 1 |
| 209 | 43T79321 | CAP, DRAIN | 1 | 1 |
| 210 | 43T70319 | ASM-HOSE-DRAIN | 1 | 1 |
| 211 | 43T39357 | FLANGE | 1 | 1 |
| 212 | 43T47332 | BONNET, 9.52 DIA | 1 | 1 |
| 213 | 43T83311 | BAND, HOSE | 1 | 1 |
| 214 | 43T82339 | SOCKET | 1 | 1 |
| 215 | 43T97323 | NUT, FLARE, 5/8 IN | 1 | 1 |
| 216 | 43T97321 | NUT, FLARE, 3/8 IN | 1 | 1 |
| 217 | 43T47334 | BONNET; 15.88 DIA | 1 | 1 |
| 218 | 43T77301 | PUMP ASSY | 1 | 1 |
| 219 | 43T51312 | SWITCH, FLOAT | 1 | 1 |
| 221 | 43T80341 | AIR FILTER | 2 | 2 |
| 222 | 43T39415 | BAND-MOTOR-R | 1 | 1 |
| 223 | 43T39416 | BAND-MOTOR-L | 1 | 1 |
| 224 | 43T39417 | BASE-MOTOR | 1 | 1 |
| 226 | 43T19333 | HOLDER, SENSOR | 2 | 2 |
| 227 | 43T82330 | RAIL, FILTER ASSY | 1 | 1 |
| 229 | 43T82323 | FILTER, STOPPER | 1 | 1 |
| 231 | 43T85879 | OWNER'S MANUAL | 1 | - |
| 231 | 43T85880 | OWNER'S MANUAL | - | 1 |

RAV-HM901BTP-E, RAV-HM1101BTP-E(TR), RAV-HM1401BTP-E(TR), RAV-HM1601BTP-E(TR)

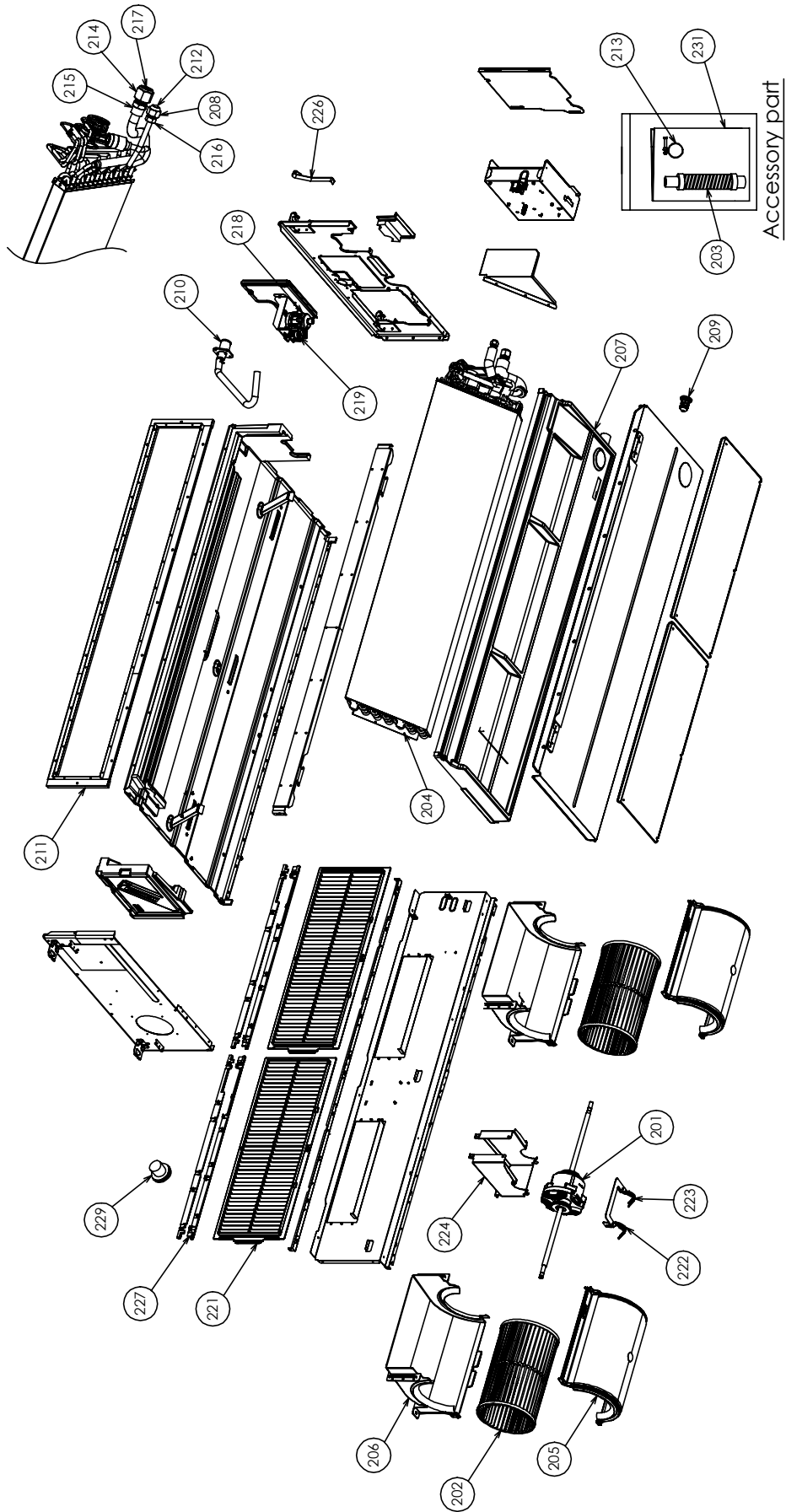

| Location No. | Part No. | Description | Model name RAV-HM | | | | | | |
|--------------|----------|----------------------------|----------------------|---------------|----------------|---------------|----------------|---------------|----------------|
| | | | 901 BTP-E | 1101 BTP-E | 1101 BTP-TR | 1401 BTP-E | 1401 BTP-TR | 1601 BTP-E | 1101 BTP-TR |
| 201 | 43T21446 | MOTOR, FAN | 1 | 1 | 1 | 1 | 1 | 1 | 1 |
| 202 | 43T20339 | FAN, MULTI BLADE | 2 | 2 | 2 | 2 | 2 | 2 | 2 |
| 203 | 43T70315 | HOSE, DRAIN | 1 | 1 | 1 | 1 | 1 | 1 | 1 |
| 204 | 43T44617 | REFRIGERANT CYCLE ASSEMBLY | 1 | 1 | 1 | 1 | 1 | 1 | 1 |
| 205 | 43T22336 | CASE, FAN, LOWER | 2 | 2 | 2 | 2 | 2 | 2 | 2 |
| 206 | 43T22338 | CASE, FAN, UPPER | 2 | 2 | 2 | 2 | 2 | 2 | 2 |
| 207 | 43T72319 | PAN ASSY, DRAIN | 1 | 1 | 1 | 1 | 1 | 1 | 1 |
| 208 | 43T82337 | SOCKET | 1 | 1 | 1 | 1 | 1 | 1 | 1 |
| 209 | 43T79321 | CAP, DRAIN | 1 | 1 | 1 | 1 | 1 | 1 | 1 |
| 210 | 43T70319 | ASM-HOSE-DRAIN | 1 | 1 | 1 | 1 | 1 | 1 | 1 |
| 211 | 43T39358 | FLANGE | 1 | 1 | 1 | 1 | 1 | 1 | 1 |
| 212 | 43T47332 | BONNET, 9.52 DIA | 1 | 1 | 1 | 1 | 1 | 1 | 1 |
| 213 | 43T83311 | BAND, HOSE | 1 | 1 | 1 | 1 | 1 | 1 | 1 |
| 214 | 43T82339 | SOCKET | 1 | 1 | 1 | 1 | 1 | 1 | 1 |
| 215 | 43T97323 | NUT, FLARE, 5/8 IN | 1 | 1 | 1 | 1 | 1 | 1 | 1 |
| 216 | 43T97321 | NUT, FLARE, 3/8 IN | 1 | 1 | 1 | 1 | 1 | 1 | 1 |
| 217 | 43T47334 | BONNET; 15.88 DIA | 1 | 1 | 1 | 1 | 1 | 1 | 1 |
| 218 | 43T77301 | PUMP ASSY | 1 | 1 | 1 | 1 | 1 | 1 | 1 |
| 219 | 43T51312 | SWITCH, FLOAT | 1 | 1 | 1 | 1 | 1 | 1 | 1 |
| 221 | 43T80340 | AIR FILTER | 2 | 2 | 2 | 2 | 2 | 2 | 2 |
| 222 | 43T39415 | BAND-MOTOR-R | 1 | 1 | 1 | 1 | 1 | 1 | 1 |
| 223 | 43T39416 | BAND-MOTOR-L | 1 | 1 | 1 | 1 | 1 | 1 | 1 |
| 224 | 43T39418 | BASE-MOTOR | 1 | 1 | 1 | 1 | 1 | 1 | 1 |
| 226 | 43T19333 | HOLDER, SENSOR | 2 | 2 | 2 | 2 | 2 | 2 | 2 |
| 227 | 43T82331 | RAIL, FILTER ASSY | 1 | 1 | 1 | 1 | 1 | 1 | 1 |
| 229 | 43T82323 | FILTER, STOPPER | 1 | 1 | 1 | 1 | 1 | 1 | 1 |
| 231 | 43T85879 | OWNER'S MANUAL | 1 | 1 | - | 1 | - | 1 | - |
| 231 | 43T85880 | OWNER'S MANUAL | - | - | 1 | - | 1 | - | 1 |

12-2. Electric parts

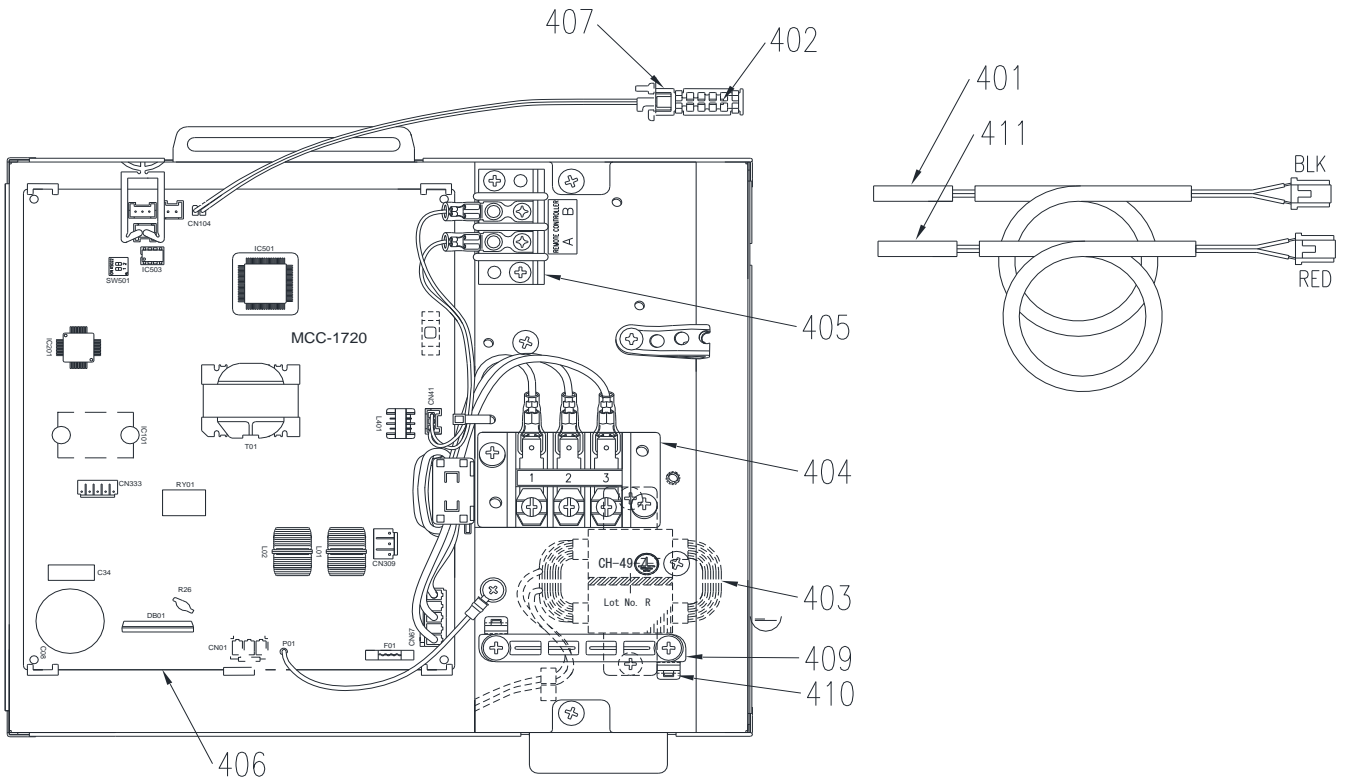

| Location No. | Part No. | Description | Model name RAV-HM | | | | | | |
|--------------|----------|--------------------------|----------------------|------------------|------------------|----------|-------------------|-------------------|-------------------|
| | | | 561 BTP-E(TR) | 801 BTP-E(TR) | 561 BTP-E(TR) | 901BTP-E | 1101 BTP-E(TR) | 1401 BTP-E(TR) | 1601 BTP-E(TR) |
| 401 | 43T50420 | TC-SENSOR (BLK) | 1 | 1 | 1 | 1 | 1 | 1 | 1 |
| 402 | 43T50389 | TA-SENSOR | 2 | 2 | 2 | 2 | 2 | 2 | 2 |
| 403 | 43T58320 | REACTOR | 1 | 1 | 1 | 1 | 1 | 1 | 1 |
| 404 | 43T60427 | TERMINAL BLOCK | 1 | 1 | 1 | 1 | 1 | 1 | 1 |
| 405 | 43T60434 | TERMINAL BLOCK, 2P | 2 | 2 | 2 | 2 | 2 | 2 | 2 |
| 406 | 43TN9668 | PC BOARD ASSY (MCC-1720) | 2 | 2 | 2 | 2 | 2 | 2 | 2 |
| 407 | 43T50351 | HOLDER-TA | 1 | 1 | 1 | 1 | 1 | 1 | 1 |
| 409 | 43T63348 | CLAMP, DOWN | 1 | 1 | 1 | 1 | 1 | 1 | 1 |
| 410 | 43T63349 | CLAMP, UP | 1 | 1 | 1 | 1 | 1 | 1 | 1 |
| 411 | 43T50386 | TCJ SENSOR (RED) | 1 | 1 | 1 | 1 | 1 | 1 | 1 |

WARNINGS ON REFRIGERANT LEAKAGE

Check of Concentration Limit

The room in which the air conditioner is to be installed requires a design that in the event of refrigerant gas leaking out, its concentration will not exceed a set limit.

The refrigerant R32 which is used in the air conditioner is safe, without the toxicity or combustibility of ammonia, and is not restricted by laws to be imposed which protect the ozone layer.

However, since it contains more than air, it poses the risk of suffocation if its concentration should rise excessively. Suffocation from leakage of R32 is almost non-existent.

With the recent increase in the number of high concentration buildings, however, the installation of multi air conditioner systems is on the increase because of the need for effective use of floor space, individual control, energy conservation by curtailing heat and carrying power etc.

Most importantly, the multi air conditioner system is able to replenish a large amount of refrigerant compared with conventional individual air conditioners.

If a single unit of the multi conditioner system is to be installed in a small room, select a suitable model and installation procedure so that if the refrigerant accidentally leaks out, its concentration does not reach the limit (and in the event of an emergency, measures can be made before injury can occur).

In a room where the concentration may exceed the limit, create an opening with adjacent rooms, or install mechanical ventilation combined with a gas leak detection device.

The concentration is as given below.

$$\frac{\text{Total amount of refrigerant (kg)}}{\text{Min. volume of the indoor unit installed room (m}^3\text{)}} \leq \text{Concentration limit (kg/m}^3\text{)}$$

The concentration limit of R32 which is used in multi air conditioners is 0.3kg/m³.

NOTE 1 :

If there are 2 or more refrigerating systems in a single refrigerating device, the amounts of refrigerant should be as charged in each independent device.

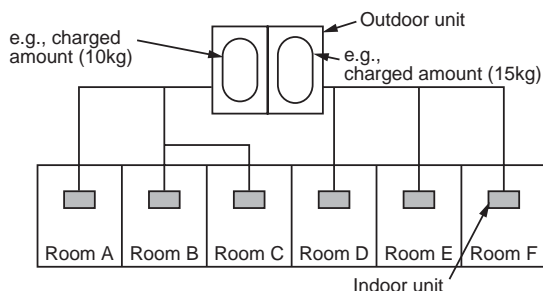

For the amount of charge in this example:

The possible amount of leaked refrigerant gas in rooms A, B and C is 10kg.

The possible amount of leaked refrigerant gas in rooms D, E and F is 15kg.

Important

NOTE 2 :

The standards for minimum room volume are as follows.

- (1) No partition (shaded portion)

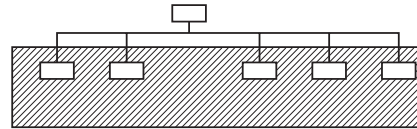

- (2) When there is an effective opening with the adjacent room for ventilation of leaking refrigerant gas (opening without a door, or an opening 0.15% or larger than the respective floor spaces at the top or bottom of the door).

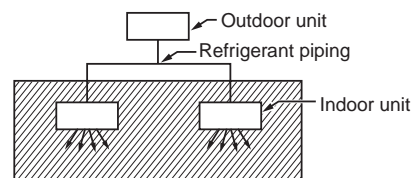

- (3) If an indoor unit is installed in each partitioned room and the refrigerant piping is interconnected, the smallest room of course becomes the object. But when a mechanical ventilation is installed interlocked with a gas leakage detector in the smallest room where the density limit is exceeded, the volume of the next smallest room becomes the object.

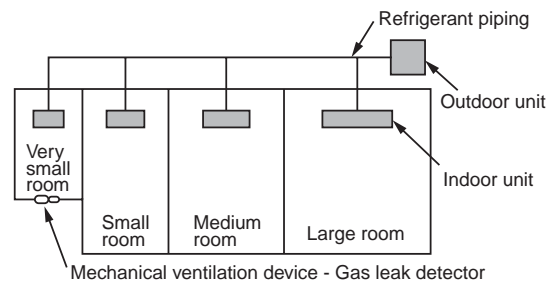

NOTE 3 :

The minimum indoor floor area compared with the amount of refrigerant is roughly as follows: (When the ceiling is 2.7m high)

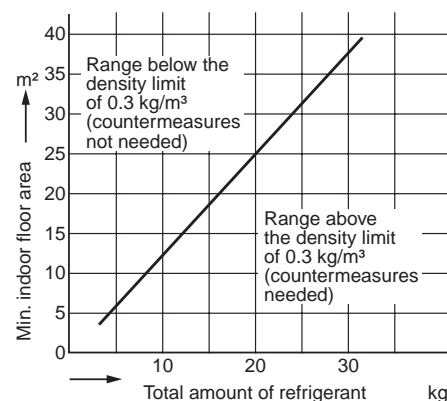

Toshiba Carrier (Thailand) Co., Ltd.

**144/9 MOO 5, BANGKADI INDUSTRIAL PARK, TIVANON ROAD, TAMBOL BANGKADI,
AMPHUR MUANG, PATHUMTHANI 12000, THAILAND.**