

TOSHIBA

SERVICE MANUAL

AIR-CONDITIONER (SPLIT TYPE)

OUTDOOR UNIT
<DIGITAL INVERTER>

RAV-GM301ATP-E (TR)

RAV-GM401ATP-E (TR)

RAV-GM301ATJP-E

RAV-GM401ATJP-E

RAV-GM301ATP-NZ

RAV-GM401ATP-NZ

R32

INVERTER



Original instruction

Adoption of Refrigerant

To prevent the ozone layer destruction, this air conditioner adopted refrigerant R32 instead the conventional refrigerant R22.

CONTENTS

SAFETY CAUTION	3
1. SPECIFICATIONS	17
1-1. Outdoor Unit	17
1-2. Operation Characteristic Curve	18
2. CONSTRUCTION VIEWS (EXTERNAL VIEWS)	20
2-1. RAV-GM301AT*P*, RAV-GM401AT*P*	20
3. SYSTEMATIC REFRIGERATING CYCLE DIAGRAM	21
3-1. Outdoor Unit	21
3-2. Operation Data	23
4. WIRING DIAGRAM	24
4-1. RAV-GM301AT*P*	24
4-2. RAV-GM401AT*P*	24
5. SPECIFICATIONS OF ELECTRICAL PARTS	25
6. REFRIGERANT R32	26
6-1. Safety During Installation/Serviceing	26
6-2. Refrigerant Piping Installation	26
6-3. Tools	30
6-4. Recharging of Refrigerant	30
6-5. Brazing of Pipes	31
6-6. Instructions for Re-use Piping of R22 or R407C	33
6-7. Replenishing refrigerant	36
7. OUTDOOR CONTROL CIRCUIT	37
7-1. Outline of Main Controls	37
7-2. Outdoor Print Circuit Board	43
8. TROUBLESHOOTING	44
8-1. Summary of Troubleshooting	44
8-2. Troubleshooting	46
8-3. Table Inspection of outdoor unit main parts	63
9. SETUP AT LOCAL SITE AND OTHERS	64
9-1. Calling of Error History	64
9-2. Group Control Operation	64
10. ADDRESS SETUP	66
10-1. Address Setup Procedure	66
10-2. Address Setup & Group Control	67
10-3. Remote Controller Wiring	70
10-4. Address Setup (Manual setting from remote controller)	70
10-5. Confirmation of Indoor Unit No. Position	71
11. HOW TO EXCHANGE COMPRESSOR	73
11-1. Exchanging Procedure of Compressor (Outline)	73
11-2. Exchange of Compressor	73
12. DETACHMENTS	74
12-1. RAV-GM301AT*P*, RAV-GM401AT*P*	74
13. EXPLODED VIEWS AND PARTS LIST	83
13-1. RAV-GM301ATP-E, RAV-GM301ATP-TR, RAV-GM301ATP-NZ	83
13-2. RAV-GM301ATJP-E	87
13-3. RAV-GM401ATP-E, RAV-GM401ATP-TR, RAV-GM401ATP-NZ	91
13-4. RAV-GM401ATJP-E	95

SAFETY CAUTION

Please read carefully through these instructions that contain important information which complies with the Machinery Directive (Directive 2006/42/EC), and ensure that you understand them. Some of the details provided in these instructions differ from the service manual, and the instruction provided here take precedence.

Generic Denomination: Air Conditioner

Definition of Qualified Installer or Qualified Service Person

The air conditioner must be installed, maintained, repaired and removed by a qualified installer or qualified service person.

When any of these jobs is to be done, ask a qualified installer or qualified service person to do them for you.

A qualified installer or qualified service person is an agent who has the qualifications and knowledge described in the table below.

Agent	Qualifications and knowledge which the agent must have
Qualified installer (*1)	<ul style="list-style-type: none"> • The qualified installer is a person who installs, maintains, relocates and removes the air conditioners made by Toshiba Carrier Corporation. He or she has been trained to install, maintain, relocate and remove the air conditioners made by Toshiba Carrier Corporation or, alternatively, he or she has been instructed in such operations by an individual or individuals who have been trained and is thus thoroughly acquainted with the knowledge related to these operations. • The qualified installer who is allowed to do the electrical work involved in installation, relocation and removal has the qualifications pertaining to this electrical work as stipulated by the local laws and regulations, and he or she is a person who has been trained in matters relating to electrical work on the air conditioners made by Toshiba Carrier Corporation or, alternatively, he or she has been instructed in such matters by an individual or individuals who have been trained and is thus thoroughly acquainted with the knowledge related to this work. • The qualified installer who is allowed to do the refrigerant handling and piping work involved in installation, relocation and removal has the qualifications pertaining to this refrigerant handling and piping work as stipulated by the local laws and regulations, and he or she is a person who has been trained in matters relating to refrigerant handling and piping work on the air conditioners made by Toshiba Carrier Corporation or, alternatively, he or she has been instructed in such matters by an individual or individuals who have been trained and is thus thoroughly acquainted with the knowledge related to this work. • The qualified installer who is allowed to work at heights has been trained in matters relating to working at heights with the air conditioners made by Toshiba Carrier Corporation or, alternatively, he or she has been instructed in such matters by an individual or individuals who have been trained and is thus thoroughly acquainted with the knowledge related to this work.
Qualified service person (*1)	<ul style="list-style-type: none"> • The qualified service person is a person who installs, repairs, maintains, relocates and removes the air conditioners made by Toshiba Carrier Corporation. He or she has been trained to install, repair, maintain, relocate and remove the air conditioners made by Toshiba Carrier Corporation or, alternatively, he or she has been instructed in such operations by an individual or individuals who have been trained and is thus thoroughly acquainted with the knowledge related to these operations. • The qualified service person who is allowed to do the electrical work involved in installation, repair, relocation and removal has the qualifications pertaining to this electrical work as stipulated by the local laws and regulations, and he or she is a person who has been trained in matters relating to electrical work on the air conditioners made by Toshiba Carrier Corporation or, alternatively, he or she has been instructed in such matters by an individual or individuals who have been trained and is thus thoroughly acquainted with the knowledge related to this work. • The qualified service person who is allowed to do the refrigerant handling and piping work involved in installation, repair, relocation and removal has the qualifications pertaining to this refrigerant handling and piping work as stipulated by the local laws and regulations, and he or she is a person who has been trained in matters relating to refrigerant handling and piping work on the air conditioners made by Toshiba Carrier Corporation or, alternatively, he or she has been instructed in such matters by an individual or individuals who have been trained and is thus thoroughly acquainted with the knowledge related to this work. • The qualified service person who is allowed to work at heights has been trained in matters relating to working at heights with the air conditioners made by Toshiba Carrier Corporation or, alternatively, he or she has been instructed in such matters by an individual or individuals who have been trained and is thus thoroughly acquainted with the knowledge related to this work.

Definition of Protective Gear

When the air conditioner is to be transported, installed, maintained, repaired or removed, wear protective gloves and “safety” work clothing.



In addition to such normal protective gear, wear the protective gear described below when undertaking the special work detailed in the table below.

Failure to wear the proper protective gear is dangerous because you will be more susceptible to injury, burns, electric shocks and other injuries.

Work undertaken	Protective gear worn
All types of work	Protective gloves “Safety” working clothing
Electrical-related work	Gloves to provide protection for electricians Insulating shoes Clothing to provide protection from electric shock
Work done at heights (50 cm or more)	Helmets for use in industry
Transportation of heavy objects	Shoes with additional protective toe cap
Repair of outdoor unit	Gloves to provide protection for electricians



The important contents concerned to the safety are described on the product itself and on this Service Manual. Please read this Service Manual after understanding the described items thoroughly in the following contents (Indications/Illustrated marks), and keep them.

[Explanation of indications]

Indication	Explanation
 DANGER	Indicates contents assumed that an imminent danger causing a death or serious injury of the repair engineers and the third parties when an incorrect work has been executed.
 WARNING	Indicates possibilities assumed that a danger causing a death or serious injury of the repair engineers, the third parties, and the users due to troubles of the product after work when an incorrect work has been executed.
 CAUTION	Indicates contents assumed that an injury or property damage (*) may be caused on the repair engineers, the third parties, and the users due to troubles of the product after work when an incorrect work has been executed.

* Property damage : Enlarged damage concerned to property, furniture, and domestic animal/pet

[Explanation of illustrated marks]





Mark	Explanation
	Indicates prohibited items (Forbidden items to do) The sentences near an illustrated mark describe the concrete prohibited contents.
	Indicates mandatory items (Compulsory items to do) The sentences near an illustrated mark describe the concrete mandatory contents.
	Indicates cautions (Including danger/warning) The sentences or illustration near or in an illustrated mark describe the concrete cautious contents.









■ Warning Indications on the Air Conditioner Unit



[Confirmation of warning label on the main unit]

Confirm that labels are indicated on the specified positions

If removing the label during parts replace, stick it as the original.

	<p>WARNING (Risk of fire)</p>	<p>This mark is for R32 refrigerant only. Refrigerant type is written on nameplate of outdoor unit. In case that refrigerant type is R32, this unit uses a flammable refrigerant. If refrigerant leaks and comes in contact with fire or heating part, it will create harmful gas and there is risk of fire.</p>
	<p>Read the OWNER'S MANUAL carefully before operation.</p>	
	<p>Service personnel are required to carefully read the OWNER'S MANUAL and INSTALLATION MANUAL before operation.</p>	
	<p>Further information is available in the OWNER'S MANUAL, INSTALLATION MANUAL, and the like.</p>	



Warning indication	Description			
<table border="1" style="width: 100%;"> <tr> <td data-bbox="188 1024 337 1276" rowspan="2">  </td> <td data-bbox="337 1024 729 1104"> <p>WARNING</p> </td> </tr> <tr> <td data-bbox="337 1104 729 1276"> <p>ELECTRICAL SHOCK HAZARD Disconnect all remote electric power supplies before servicing.</p> </td> </tr> </table>		<p>WARNING</p>	<p>ELECTRICAL SHOCK HAZARD Disconnect all remote electric power supplies before servicing.</p>	<p>WARNING</p> <p>ELECTRICAL SHOCK HAZARD Disconnect all remote electric power supplies before servicing.</p>
		<p>WARNING</p>		
	<p>ELECTRICAL SHOCK HAZARD Disconnect all remote electric power supplies before servicing.</p>			
<table border="1" style="width: 100%;"> <tr> <td data-bbox="188 1340 337 1593" rowspan="2">  </td> <td data-bbox="337 1340 729 1421"> <p>WARNING</p> </td> </tr> <tr> <td data-bbox="337 1421 729 1593"> <p>Moving parts. Do not operate unit with grille removed. Stop the unit before the servicing.</p> </td> </tr> </table>		<p>WARNING</p>	<p>Moving parts. Do not operate unit with grille removed. Stop the unit before the servicing.</p>	<p>WARNING</p> <p>Moving parts. Do not operate unit with grille removed. Stop the unit before the servicing.</p>
		<p>WARNING</p>		
	<p>Moving parts. Do not operate unit with grille removed. Stop the unit before the servicing.</p>			
<table border="1" style="width: 100%;"> <tr> <td data-bbox="188 1657 337 1910" rowspan="2">  </td> <td data-bbox="337 1657 729 1738"> <p>CAUTION</p> </td> </tr> <tr> <td data-bbox="337 1738 729 1910"> <p>High temperature parts. You might get burned when removing this panel.</p> </td> </tr> </table>		<p>CAUTION</p>	<p>High temperature parts. You might get burned when removing this panel.</p>	<p>CAUTION</p> <p>High temperature parts. You might get burned when removing this panel.</p>
		<p>CAUTION</p>		
	<p>High temperature parts. You might get burned when removing this panel.</p>			

	<p style="text-align: center;">CAUTION</p> <hr/> <p>Do not touch the aluminum fins of the unit. Doing so may result in injury.</p>	<p>CAUTION</p> <p>Do not touch the aluminum fins of the unit. Doing so may result in injury.</p>
	<p style="text-align: center;">CAUTION</p> <hr/> <p style="text-align: center;">BURST HAZARD</p> <p>Open the service valves before the operation, otherwise there might be the burst.</p>	<p>CAUTION</p> <p>BURST HAZARD</p> <p>Open the service valves before the operation, otherwise there might be the burst.</p>
	<p style="text-align: center;">WARNING</p> <hr/> <p>Capacitor connected within this disconnect or downstream upon shutdown wait 5 minutes to allow capacitors to discharge.</p>	<p>WARNING</p> <p>Open the service valves before the operation, otherwise there might be the burst.</p>

Precaution for Safety









The appliance shall be installed in accordance with national wiring regulations. Capacity shortages of the power circuit or an incomplete installation may cause an electric shock or fire.





DANGER





 Turn off breaker.	<p>Before carrying out the installation, maintenance, repair or removal work, be sure to set the circuit breaker to the OFF position. Otherwise, electric shocks may result.</p>
	<p>Before opening the intake grille of the indoor unit or service panel or valve cover of the outdoor unit, set the circuit breaker to the OFF position. Failure to set the circuit breaker to the OFF position may result in electric shocks through contact with the interior parts. Only a qualified installer (*1) or qualified service person (*1) is allowed to remove the intake grille of the indoor unit or service panel of the outdoor unit and do the work required.</p>
	<p>Before starting to repair the outdoor unit fan or fan guard, be absolutely sure to set the circuit breaker to the OFF position, and place a "Work in progress" sign on the circuit breaker before proceeding with the work.</p>
	<p>When cleaning the filter or other parts of the indoor unit, set the circuit breaker to OFF without fail, and place a "Work in progress" sign near the circuit breaker before proceeding with the work.</p>
 Prohibition	<p>Do not turn ON the circuit breaker under the condition of removing a cabinet, a panel, etc. Otherwise, it leads to an electric shock with a high voltage, resulting in loss of life.</p>



WARNING

 General	<p>Before starting to repair the air conditioner, read carefully through the Service Manual, and repair the air conditioner by following its instructions.</p>
	<p>Only qualified service person (*1) is allowed to repair the air conditioner. Repair of the air conditioner by unqualified person may give rise to a fire, electric shocks, injury, water leaks and/or other problems.</p>
	<p>Only a qualified installer (*1) or qualified service person (*1) is allowed to carry out the electrical work of the air conditioner. Under no circumstances must this work be done by an unqualified individual since failure to carry out the work properly may result in electric shocks and/or electrical leaks.</p>
	<p>Wear protective gloves and safety work clothing during installation, servicing and removal.</p>
	<p>When connecting the electrical wires, repairing the electrical parts or undertaking other electrical jobs, wear gloves to provide protection for electricians, insulating shoes and clothing to provide protection from electric shocks. Failure to wear this protective gear may result in electric shocks.</p>
	<p>Use wiring that meets the specifications in the Installation Manual and the stipulations in the local regulations and laws. Use of wiring which does not meet the specifications may give rise to electric shocks, electrical leakage, smoking and/or a fire.</p>
	<p>Only a qualified installer (*1) or qualified service person (*1) is allowed to undertake work at heights using a stand of 50 cm or more.</p>
	<p>When working at heights, use a ladder which complies with the ISO 14122 standard, and follow the procedure in the ladder's instructions. Also wear a helmet for use in industry as protective gear to undertake the work.</p>
	<p>When working at heights, put a sign in place so that no-one will approach the work location, before proceeding with the work. Parts and other objects may fall from above, possibly injuring a person below.</p>
	<p>Do not touch the aluminum fin of the outdoor unit. You may injure yourself if you do so. If the fin must be touched for some reason, first put on protective gloves and safety work clothing, and then proceed.</p>
	<p>Do not climb onto or place objects on top of the outdoor unit. You may fall or the objects may fall off of the outdoor unit and result in injury.</p>
	<p>When transporting the air conditioner, wear shoes with additional protective toe caps.</p>
	<p>When transporting the air conditioner, do not take hold of the bands around the packing carton. You may injure yourself if the bands should break.</p>
	<p>This air conditioner has passed the pressure test as specified in IEC 60335-2-40 Annex EE.</p>



 Electric shock hazard	<p>When you access inside of the electric cover to repair electric parts, wait for about five minutes after turning off the breaker. Do not start repairing immediately. Otherwise you may get electric shock by touching terminals of high-voltage capacitors. Natural discharge of the capacitor takes about five minutes.</p>
 Prohibition	<p>Place a "Work in progress" sign near the circuit breaker while the installation, maintenance, repair or removal work is being carried out. There is a danger of electric shocks if the circuit breaker is set to ON by mistake.</p> <p>When checking the electric parts, removing the cover of the electric parts box of Indoor Unit and/or front panel of Outdoor Unit inevitably to determine the failure, put a sign "Do not enter" around the site before the work. Failure to do this may result in third person getting electric shock.</p> <p>Before operating the air conditioner after having completed the work, check that the electrical parts box cover of the indoor unit and service panel of the outdoor unit are closed, and set the circuit breaker to the ON position. You may receive an electric shock if the power is turned on without first conducting these checks.</p>
 Stay on protection	<p>If, in the course of carrying out repairs, it becomes absolutely necessary to check out the electrical parts with the electrical parts box cover of one or more of the indoor units and the service panel of the outdoor unit removed in order to find out exactly where the trouble lies, wear insulated heat-resistant gloves, insulated boots and insulated work overalls, and take care to avoid touching any live parts. You may receive an electric shock if you fail to heed this warning. Only qualified service person (*1) is allowed to do this kind of work.</p>
 Check earth wires.	<p>Before troubleshooting or repair work, check the earth wire is connected to the earth terminals of the main unit, otherwise an electric shock is caused when a leak occurs. If the earth wire is not correctly connected, contact an electric engineer for rework.</p> <p>After completing the repair or relocation work, check that the ground wires are connected properly. Be sure to connect earth wire. (Grounding work) Incomplete grounding causes an electric shock. Do not connect ground wires to gas pipes, water pipes, and lightning rods or ground wires for telephone wires.</p>
 Prohibition of modification.	<p>Do not modify the products. Do not also disassemble or modify the parts. It may cause a fire, electric shock or injury.</p>
 Use specified parts.	<p>When any of the electrical parts are to be replaced, ensure that the replacement parts satisfy the specifications given in the Service Manual (or use the parts contained on the parts list in the Service Manual). Use of any parts which do not satisfy the required specifications may give rise to electric shocks, smoking and/or a fire.</p> <p>Replace components only with parts specified by the manufacturer. Other parts may result in the ignition of refrigerant in the atmosphere from a leak.</p>
 Do not bring a child close to the equipment.	<p>If, in the course of carrying out repairs, it becomes absolutely necessary to check out the electrical parts with the electrical parts box cover of one or more of the indoor units and the service panel of the outdoor unit removed in order to find out exactly where the trouble lies, place Keep out signs around the work site before proceeding. Third-party individuals may enter the work site and receive electric shocks if this warning is not heeded.</p>
 Insulating measures	<p>Connect the cut-off lead wires with crimp contact, etc., put the closed end side upward and then apply a water-cut method, otherwise a leak or production of fire is caused at the users' side.</p>

 No fire	<p>When performing repairs using a gas burner, replace the refrigerant with nitrogen gas because the oil that coats the pipes may otherwise burn.</p> <p>When repairing the refrigerating cycle, take the following measures.</p> <ol style="list-style-type: none"> 1) Be attentive to fire around the cycle. When using a gas stove, etc., be sure to put out fire before work; otherwise the oil mixed with refrigerant gas may catch fire. 2) Do not use a welder in the closed room. When using it without ventilation, carbon monoxide poisoning may be caused. 3) Do not bring inflammables close to the refrigerant cycle, otherwise fire of the welder may catch the inflammables.
 Refrigerant	<p>The refrigerant used by this air conditioner is the R32.</p> <p>Check the used refrigerant name and use tools and materials of the parts which match with it. For the products which use R32 refrigerant, the refrigerant name is indicated at a position on the outdoor unit where is easy to see. To prevent miss-charging, the route of the service port is changed from one of the former R22. Be careful for miss-charging since a charging port of R32 is the same diameter as that of R410A.</p> <p>Do not use any refrigerant different from the one specified for complement or replacement. Otherwise, abnormally high pressure may be generated in the refrigeration cycle, which may result in a failure or explosion of the product or an injury to your body.</p> <p>For an air conditioner which uses R32, never use other refrigerant than R32. For an air conditioner which uses other refrigerant (R22, R410A etc.), never use R32. If different types of refrigerant are mixed, abnormal high pressure generates in the refrigerating cycle and an injury due to breakage may be caused. If the different type of refrigerants are mixed in, be sure to recharge the refrigerant</p> <p>Do not charge refrigerant additionally. If charging refrigerant additionally when refrigerant gas leaks, the refrigerant composition in the refrigerating cycle changes resulted in change of air conditioner characteristics or refrigerant over the specified standard amount is charged and an abnormal high pressure is applied to the inside of the refrigerating cycle resulted in cause of breakage or injury. Therefore if the refrigerant gas leaks, recover the refrigerant in the air conditioner, execute vacuuming, and then newly recharge the specified amount of liquid refrigerant. In this time, never charge the refrigerant over the specified amount.</p> <p>When recharging the refrigerant in the refrigerating cycle, do not mix the refrigerant or air other than R32 into the specified refrigerant. If air or others is mixed with the refrigerant, abnormal high pressure generates in the refrigerating cycle resulted in cause of injury due to breakage.</p> <p>After the installation work, confirm that refrigerant gas does not leak. If refrigerant gas leaks into the room and flows near a fire source, such as a cooking range, it may generate noxious gases, causing a fire.</p> <p>Never recover the refrigerant into the outdoor unit. When the equipment is moved or repaired, be sure to recover the refrigerant with recovering device. The refrigerant cannot be recovered in the outdoor unit; otherwise a serious accident such as breakage or injury is caused.</p>
 Assembly/ Wiring	<p>After repair work, surely assemble the disassembled parts, and connect and lead the removed wires as before. Perform the work so that the cabinet or panel does not catch the inner wires. If incorrect assembly or incorrect wire connection was done, a disaster such as a leak or fire is caused at user's side.</p>
 Insulator check	<p>After the work has finished, be sure to use an insulation tester set (500V Megger) to check the resistance is 1MΩ or more between the charge section and the non-charge metal section (Earth position). If the resistance value is low, a disaster such as a leak or electric shock is caused at user's side.</p>
 Ventilation	<p>When the refrigerant gas leaks during work, execute ventilation. If the refrigerant gas touches to a fire, it may generate noxious gases, causing a fire. A case of leakage of the refrigerant and the closed room full with gas is dangerous because a shortage of oxygen occurs. Be sure to execute ventilation.</p> <p>If refrigerant gas has leaked during the installation work, ventilate the room immediately. If the leaked refrigerant gas comes in contact with fire, it may generate noxious gases, causing a fire.</p>

 Compulsion	<p>When the refrigerant gas leaks, find up the leaked position and repair it surely. If the leaked position cannot be found up and the repair work is interrupted, pump-down and tighten the service valve, otherwise the refrigerant gas may leak into the room. When gas touches to fire such as fan heater, stove or cooking stove, it may generate noxious gases, causing a fire though the refrigerant gas itself is innocuous. When installing equipment which includes a large amount of charged refrigerant such as a multi air conditioner in a sub-room, it is necessary that the density does not the limit even if the refrigerant leaks. If the refrigerant leaks and exceeds the limit density, an accident of shortage of oxygen is caused.</p> <p>Tighten the flare nut with a torque wrench in the specified manner. Excessive tighten of the flare nut may cause a crack in the flare nut after a long period, which may result in refrigerant leakage.</p> <p>Nitrogen gas must be used for the airtight test.</p> <p>The charge hose must be connected in such a way that it is not slack.</p> <p>For the installation/moving/reinstallation work, follow to the Installation Manual. If an incorrect installation is done, a trouble of the refrigerating cycle, water leak, electric shock or fire is caused.</p> <p>Install the outdoor unit properly in a location that is durable enough to support the weight of the outdoor unit. Insufficient durability may cause the outdoor unit to fall, which may result in injury.</p>
 Check after repair	<p>Once the repair work has been completed, check for refrigerant leaks, and check the insulation resistance and water drainage. Then perform a trial run to check that the air conditioner is running properly.</p> <p>After repair work has finished, check there is no trouble. If check is not executed, a fire, electric shock or injury may be caused. For a check, turn off the power breaker.</p> <p>After repair work (installation of front panel and cabinet) has finished, execute a test run to check there is no generation of smoke or abnormal sound. If check is not executed, a fire or an electric shock is caused. Before test run, install the front panel and cabinet.</p>
 Do not operate the unit with the valve closed.	<p>Check the following matters before a test run after repairing piping.</p> <ul style="list-style-type: none"> • Connect the pipes surely and there is no leak of refrigerant. • The valve is opened. <p>Running the compressor under condition that the valve closes causes an abnormal high pressure resulted in damage of the parts of the compressor and etc. and moreover if there is leak of refrigerant at connecting section of pipes, the air is suctioned and causes further abnormal high pressure resulted in burst or injury.</p>
 Check after reinstallation	<p>Only a qualified installer (*1) or qualified service person (*1) is allowed to relocate the air conditioner. It is dangerous for the air conditioner to be relocated by an unqualified individual since a fire, electric shocks, injury, water leakage, noise and/or vibration may result.</p> <p>Check the following items after reinstallation.</p> <ol style="list-style-type: none"> 1) The earth wire is correctly connected. 2) The power cord is not caught in the product. 3) There is no inclination or unsteadiness and the installation is stable. <p>If check is not executed, a fire, an electric shock or an injury is caused.</p>
 Cooling check	<p>When the service panel of the outdoor unit is to be opened in order for the compressor or the area around this part to be repaired immediately after the air conditioner has been shut down, set the circuit breaker to the OFF position, and then wait at least 10 minutes before opening the service panel. If you fail to heed this warning, you will run the risk of burning yourself because the compressor pipes and other parts will be very hot to the touch. In addition, before proceeding with the repair work, wear the kind of insulated heat-resistant gloves designed to protect electricians.</p> <p>When the service panel of the outdoor unit is to be opened in order for the fan motor, reactor, inverter or the areas around these parts to be repaired immediately after the air conditioner has been shut down, set the circuit breaker to the OFF position, and then wait at least 10 minutes before opening the service panel. If you fail to heed this warning, you will run the risk of burning yourself because the fan motor, reactor, inverter heat sink and other parts will be very hot to the touch. In addition, before proceeding with the repair work, wear the kind of insulated heat-resistant gloves designed to protect electricians.</p>

 Installation	Only a qualified installer (*1) or qualified service person (*1) is allowed to install the air conditioner. If the air conditioner is installed by an unqualified individual, a fire, electric shocks, injury, water leakage, noise and/or vibration may result.
	Before starting to install the air conditioner, read carefully through the Installation Manual, and follow its instructions to install the air conditioner.
	Do not install the air conditioner in a location that may be subject to a risk of exposure to a combustible gas. If a combustible gas leaks and becomes concentrated around the unit, a fire may occur.
	When transporting the air conditioner, use a forklift and when moving the air conditioner by hand, move the unit with 2 people.(GM56,80) or move the unit with 4 people(GM110,140)
	Install a circuit breaker that meets the specifications in the installation manual and the stipulations in the local regulations and laws.
	Install the circuit breaker where it can be easily accessed by the agent.
	Do not place any combustion appliance in a place where it is directly exposed to the wind of air conditioner, otherwise it may cause imperfect combustion.
 Compulsion	When carrying out the pump-down work shut down the compressor before disconnecting the refrigerant pipe. Disconnecting the refrigerant pipe with the service valve left open and the compressor still operating will cause air, etc. to be sucked in, raising the pressure inside the refrigeration cycle to an abnormally high level, and possibly resulting in reputing, injury, etc.
	When removing the welding parts of suction and discharge pipe for the compressor, remove them at the place ventilated well after recovering the refrigerant. Improper recovering may cause the spurt of the refrigerant and the refrigeration oil, causing a injury.
 Prohibition	Do not vent gases to the atmosphere. Venting gases to the atmosphere is prohibited by the law.

CAUTION

 Wearing of gloves	Ensure wearing of gloves when performing any work in order to avoid injury from parts, etc. Failure to wear the proper protective gloves cause a injury due to the parts, etc.
 Confirm	When performing the welding work, check whether refrigerant leaks or remains. If the leakage refrigerant gas touches a fire source, it may generate noxious gases, causing a fire.

Explanations given to user

- If you have discovered that the fan grille is damaged, do not approach the outdoor unit but set the circuit breaker to the OFF position, and contact a qualified service person to have the repairs done.
Do not set the circuit breaker to the ON position until the repairs are completed.

Relocation

- Only a qualified installer (*1) or qualified service person (*1) is allowed to relocate the air conditioner.
It is dangerous for the air conditioner to be relocated by an unqualified individual since a fire, electric shocks, injury, water leakage, noise and/or vibration may result.
- When carrying out the pump-down work shut down the compressor before disconnecting the refrigerant pipe.
Disconnecting the refrigerant pipe with the service valve left open and the compressor still operating will cause air, etc. to be sucked in, raising the pressure inside the refrigeration cycle to an abnormally high level, and possibly resulting in reputing, injury, etc.

(*1) Refer to the “Definition of Qualified Installer or Qualified Service Person.”

Declaration of Conformity

Manufacturer: **TOSHIBA CARRIER (THAILAND) CO., LTD.**
144 / 9 Moo 5, Bangkadi Industrial Park, Tivanon Road, Tambol Bangkadi,
Amphur Muang, Pathumthani 12000, Thailand

TCF holder: TOSHIBA CARRIER EUROPE S.A.S
Route de Thil 01120 Montluel FRANCE

Hereby declares that the machinery described below:

Generic Denomination: Air Conditioner
Model/type: RAV-GM301ATP-E, RAV-GM401ATP-E,
RAV-GM301ATJP-E, RAV-GM401ATJP-E,
RAV-GM301ATP-TR, RAV-GM401ATP-TR,
RAV-GM301ATP-NZ, RAV-GM401ATP-NZ

Commercial name: Digital Inverter Series Air Conditioner

Complies with the provision of the Machinery Directive (Directive 2006/42/EC) and the regulation transposing into national law.

Note: This declaration becomes invalid if technical or operational modifications are introduced without the manufacturer's consent.

Disposal

How to dispose of air conditioners with a rating of 12 kW and below in accordance with the 2002/96/EC Directive WEEE (Waste Electrical and Electronic Equipment) is provided in the Installation Manual supplied with your product. For disposal of the product above 12 kW in rating you should use a registered company in accordance with any national or EU legislation.

<Model names with a rating of 12 kW and below (outdoor units)>

DI series

RAV-GM301ATP-E, RAV-GM401ATP-E,
RAV-GM301ATJP-E, RAV-GM401ATJP-E,
RAV-GM301ATP-TR, RAV-GM401ATP-TR,
RAV-GM301ATP-NZ, RAV-GM301ATP-NZ

Specifications

Model	Sound power level (dBA)		Weight (kg)
	Cooling	Heating	
RAV-GM301ATP-E	*	*	29
RAV-GM301ATJP-E	*	*	29
RAV-GM401ATP-E	*	*	32
RAV-GM401ATJP-E	*	*	32
RAV-GM301ATP-TR	*	*	29
RAV-GM401ATP-TR	*	*	32
RAV-GM301ATP-NZ	*	*	29
RAV-GM401ATP-NZ	*	*	32

*: Under 70 dBA

Refrigerant R32

This air conditioner adopts a new HFC type refrigerant (R32) which does not deplete the ozone layer.

1. Safety Caution Concerned to Refrigerant R32

Be sure that water, dust, the former refrigerant or the former refrigerating oil is not mixed into the refrigerating cycle of the air conditioner with refrigerant R32 during installation work or service work. If an incorrect work or incorrect service is performed, there is a possibility to cause a serious accident. Use the tools and materials exclusive to R32 to purpose a safe work.

2. Safety and Cautions on Installation/Service

<Safety items>

When gas concentration and ignition energy are happened at the same time, R32 has a slight possibility of burning. Although it will not ignite under normal work environment conditions, be aware that the flame spreads if ignition should occur. It is necessary to carry out installation/servicing safely while taking the following precautions into consideration.

- 1) Never use refrigerant other than specified refrigerant (R32) in an air conditioner which is designed to operate with the specified refrigerant (R32).
If other refrigerant than R32 is used, it may cause personal injury, etc. by a malfunction, a fire, a rupture.
- 2) Since R32 is heavier than air, it tends to accumulate on the bottom (near the floor).
Ventilate properly for the working environment to prevent its combustion.
Especially in a basement or a closed room where is the high risk of the accumulation, ventilate the room with a local exhaust ventilation.
If refrigerant leakage is confirmed in the room or the place where the ventilation is insufficient, do not work until the proper ventilation is performed and the work environment is improved.
- 3) When performing brazing work, be sure to check for leakage refrigerant or residual refrigerant.
If the leakage refrigerant comes into contact with fire, a poisonous gas may occur or it may cause a fire. Keep adequate ventilation during the work.
- 4) When refrigerant gas leaks during work, execute ventilation. If the leakage refrigerant comes into contact with a fire, a poisonous gas may occur or it may cause a fire.
- 5) In places where installing / repairing air-conditioning equipment, etc., keep the source of ignition such as gas combustion equipment, petroleum combustion equipment, electric heater etc. away. Do not smoke in the place.
- 6) When installing or removing an air conditioner, do not mix air in the refrigerant cycle.
If air or others is mixed with the refrigerant, abnormal high pressure generates in the refrigerating cycle, causing injury due to the breakage.
- 7) After installation work complete, confirm that refrigerant gas is not leaking on the flare connection part or others. If leaked refrigerant comes to contact with a fire, toxic gas may occur, causing a fire.
- 8) Perform the installation work and re-installation according to the installation manual.
Pay attention especially to the area of application. Improper installation may cause refrigeration trouble or water leakage, electric shock and fire etc.
- 9) Unauthorized modifications to the air conditioner may be dangerous. If a breakdown occurs please call a qualified air conditioner technician or electrician.
Improper repair may result in water leakage, electric shock and fire, etc.
- 10) Carry out the airtight test with nitrogen at a specified pressure. Do not use oxygen or acetylene gas absolutely as it may cause an explosion.
- 11) Always carry a refrigerant leakage detection sensor during the work and work while checking that no refrigerant leaks around working environment.
- 12) If the leakage refrigerant comes into contact with fire, it may cause a fire.
Have a dry powder or CO₂ fire extinguisher adjacent to the charging area.

<Caution items>

- 1) The opposite side dimension of the air-conditioner's flared nut using R32 and the shape of the charge port are the same as those of R410A.
- 2) Be careful not to charge refrigerant by mistake. Should the different type of refrigerant mix in, be sure to recharge the refrigerant
- 3) Do not mix the other refrigerant or refrigerating oil with the refrigerant.
- 4) Since the pressure of R32 is high 1.6 times of that of the former refrigerant (R22), use tools and parts with high pressure withstand specification similar to R410A.
- 5) In the installation time, use clean pipe materials and work with great attention so that water and others do not mix in because pipes are affected by impurities such as water, oxide film, oil, etc. Use the clean pipes. Be sure to braze while flowing nitrogen gas in the pipe. (Never use gas other than nitrogen gas.)
- 6) For the earth protection, use a vacuum pump for air purge.
- 7) R32 refrigerant is Single-component refrigerant that does not change its composition. Although it is possible to charge the refrigerant with either liquid or gas, charge it with liquid. (If using gas for charging, composition of the refrigerant changes and then characteristics of the air conditioner change.)

3. Pipe Materials

For the refrigerant pipes, copper pipe and joints are mainly used.

It is necessary to select the most appropriate pipes to conform to the standard.

Use clean material in which impurities adhere inside of pipe or joint to a minimum.

1) Copper pipe

<Piping>

The pipe thickness, flare finishing size, flare nut and others differ according to a refrigerant type. When using a long copper pipe for R32, it is recommended to select "Copper or copper-base pipe without seam" and one with bonded oil amount 40mg/10m or less. Also do not use crushed, deformed, discolored (especially inside) pipes. (Impurities cause clogging of expansion valves and capillary tubes.)

<Flare nut>

Use the flare nuts which are attached to the air conditioner unit.

Be sure to select the pipes with copper thickness in the table below since the pressure of an air conditioner using R32 is higher than that of R22.

Nominal diameter	Outer diameter (mm)	Thickness (mm) R410A or R32
1/2	6.4	0.80
3/8	9.5	0.80
1/2	12.7	0.80
5/8	15.9	1.00

Make sure not to use a thin copper pipe such as 0.7 mm copper thickness in the market.

2) Joint

The flare joint and socket joint are used for joints of the copper pipe.

The joints are rarely used for installation of the air conditioner.

However clear impurities when using them.

4. Tools

Tools exclusive for R410A (The following tools for R410A are required.)

○: R410A tools available

△: Partly unavailable, ×: R410A tools unavailable

No	Installation/service tools		Use	Applicability to R32 air conditioner or not	Applicability to R22 air conditioner or not
	Tools / Equipment	specification			
1	Flare tool	Clutch type	Pipe flaring	○	○
2	Copper pipe gauge for adjusting projection margin	—	Flaring by conventional flare tool	○	—
3	Torque wrench	—	Tightening of flare nut	○	×
4	Gauge manifold	Port size 1/2"-20UNF (5/16" Flare)	Evacuating, refrigerant charge, run check, etc.	○ Note 2	×
5	Charge hose	High-voltage		○	×
6	Vacuum pump	—	Vacuum drying	○ Note 3 1/2"-20UNF(5/16" Flare)	△ Connection diameter 1/4"
7	Vacuum pump adapter	—	Vacuum drying	○ Note 4 1/2"-20UNF(5/16" Flare)	△ Connection diameter 1/4"
8	Electronic balance for refrigerant charging	For 10 kg or 20 kg cylinder	Refrigerant charge	○	○
9	Leakage detector	—	Gas leakage check	○ Note 5	○ Note 5
10	Refrigerant cylinder	—	Refrigerant charge	×	×
11	Refrigerant recovery cylinder	Exclusive for R32	Refrigerant recovery container	×	×
12	Refrigerant recovery device	—	Refrigerant recovery device	○ Note 8	△ Connection diameter 1/4"

Note 1 When flaring is carried out for R410A or R32 using the conventional flare tools, adjustment of projection margin is necessary. For this adjustment, a copper pipe gauge, etc. are necessary.

Note 2 When saturation temperature is described, the gauge manifold differs for R410A and R32. If saturation temperature reading is required, special tools exclusive for R32 are required.

Note 3 Since R32 has a slight possibility of burning, be sure to use the tools corresponding to R32.

Note 4 Like R410, a Vacuum pump adapter needs installing to prevent a Vacuum pump oil (mineral oil) from flowing backward into the Charge hose. Mixing of the Vacuum pump oil into R32 refrigerant may cause a trouble such as generation of sludge, clogging of capillary, etc.

Note 5 Be sure to use those tools after confirming they correspond to each refrigerant.

Note 6 For a refrigerant cylinder exclusive for R32, the paint color (or label color) of the cylinder is set to the specified color (light blue) together with the indication of the refrigerant name.

Note 7 Although the container specification is the same as R410A, use a recovering container exclusive for R32 to avoid mixing with other refrigerants.

Note 8 Be careful for miss-charging of the refrigerant during work. Miss-charging of the refrigerant type may cause not only damage of the equipments but also a fire etc.

General tools

In addition to the above exclusive tools, the following equipments are necessary as the general tools.

- | | |
|-----------------------|-----------------------------|
| 1) Pipe cutter | 6) Spanner or Monkey wrench |
| 2) Reamer | 7) Hole core drill |
| 3) Pipe bender | 8) Tape measure |
| 4) Level vial | 9) Metal saw |
| 5) Screwdriver (+, -) | |

Also prepare the following equipments for other installation method and run check.

- | | |
|----------------|------------------------------------------|
| 1) Clamp meter | 3) Insulation resistance tester (Megger) |
| 2) Thermometer | 4) Electrocope |

1. SPECIFICATIONS

1-1. Outdoor Unit

<Digital Inverter>

Model name	Outdoor unit	RAV-GM	301AT*P*	401AT*P*	
Power supply			1 phase 220-240V, 50Hz 1 phase 220V, 60Hz		
Compressor	Type		Rotary DC Inverter		
	Motor (kW)		0.75	1.1	
	Pole		4	4	
Refrigerant charged		(kg)	0.63	0.90	
Refrigerant control			Pulse motor valve		
Inter connecting pipe	Standard length (m)		7.5	7.5	
	Min. length (m)		2.0	2.0	
	Max. total length (m)		20	20	
	Additional refrigerant charge under long piping connector			20g/m (15m to 20m)	20g/m (15m to 20m)
	Height difference	Outdoor lower (m)		10	10
		Outdoor higher (m)		10	10
Outer dimension	Height (mm)		550	550	
	Width (mm)		780	780	
	Depth (mm)		290	290	
Appearance			Silky shade (Muncel 1Y8.5/0.5)		
Total weight		(kg)	29	34	
Heat exchanger			Finned tube		
Fan unit	Fan		Propeller fan		
	Standard air flow high (m ³ /min.)		30	37	
	Motor (W)		43	43	
Connecting pipe	Gas side (mm)		9.5	12.7	
	Liquid side (mm)		6.4	6.4	
Sound pressure level		Cooling/Heating (dB·A)	46/47	49/50	
Sound power level		Cooling/Heating (dB·A)	61/62	64/65	
Outside air temperature, Cooling		°C (Dry bulb temp.)	46 to -15		
Outside air temperature, Heating		°C (Wet bulb temp.)	24 to -15		

1-2. Operation Characteristic Curve

RAV-GM301AT*P*

<Cooling>

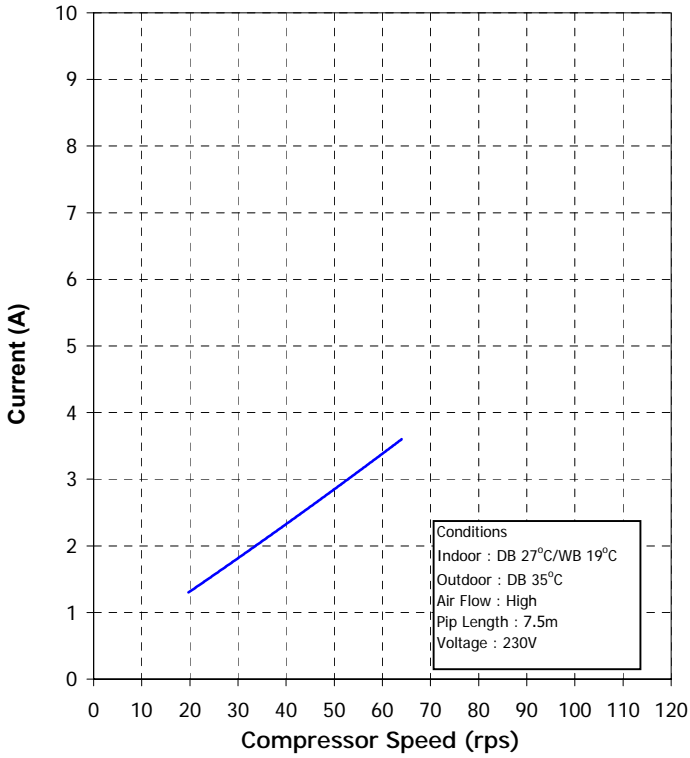

<Heating>

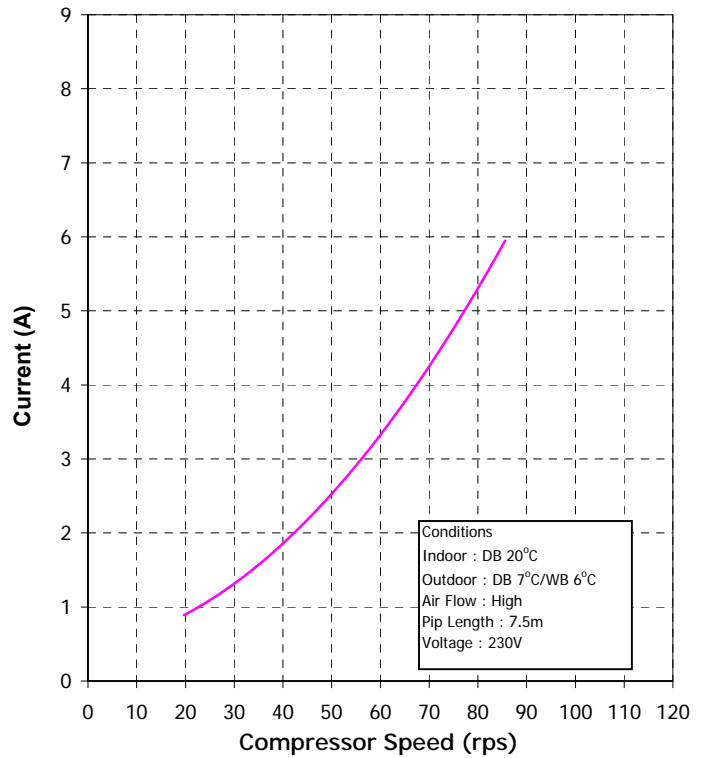

Capacity variation ratio according to temperature

<Cooling>

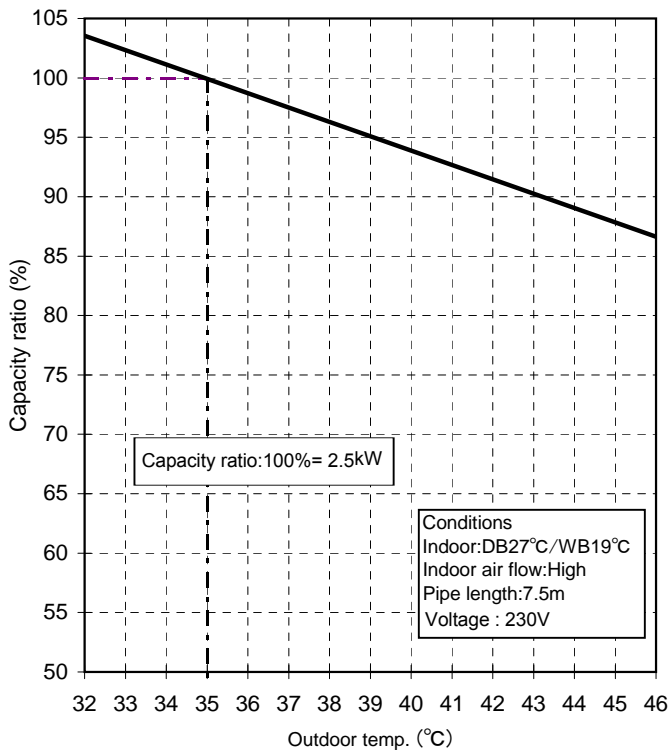

<Heating>

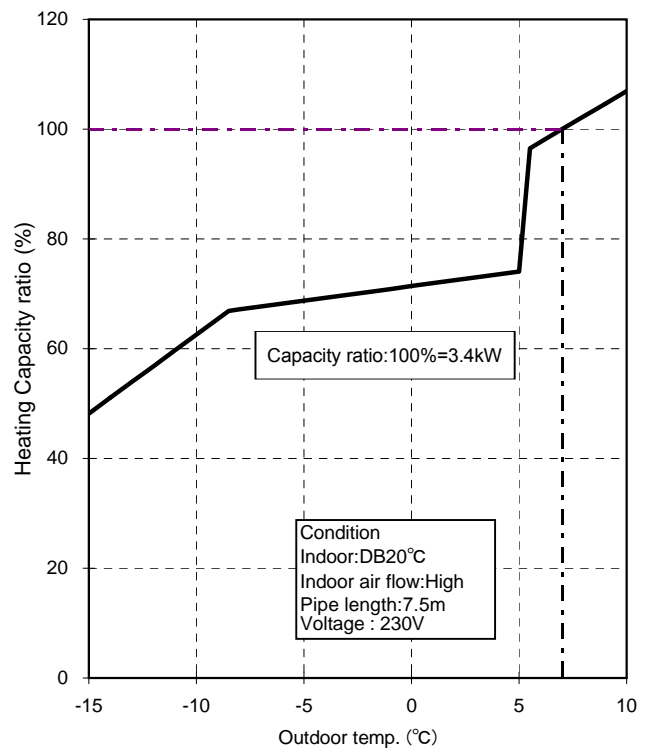

Operation Characteristic Curve

RAV-GM401AT*P*

<Cooling>

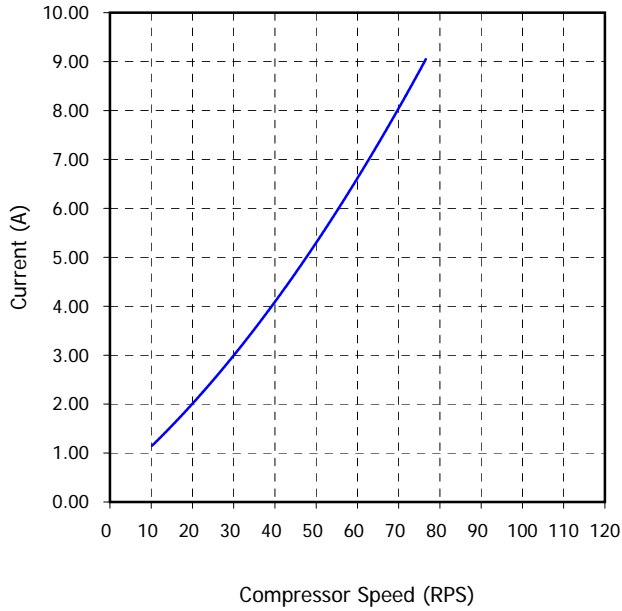

<Heating>

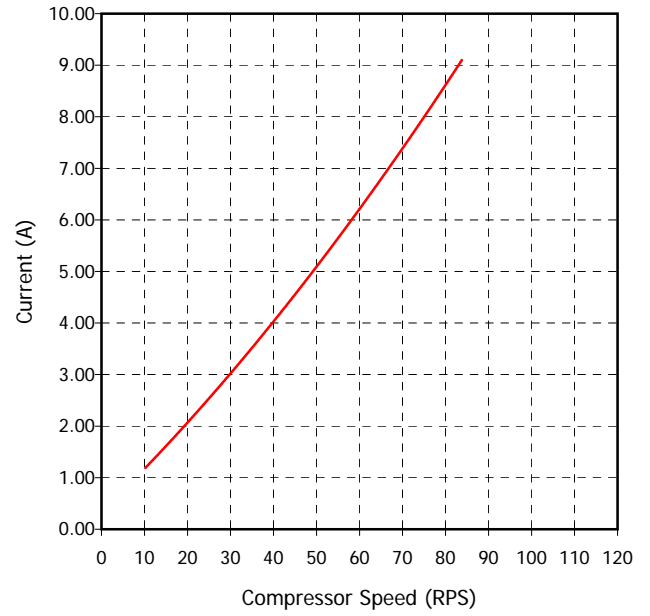

Capacity variation ratio according to temperature

<Cooling>

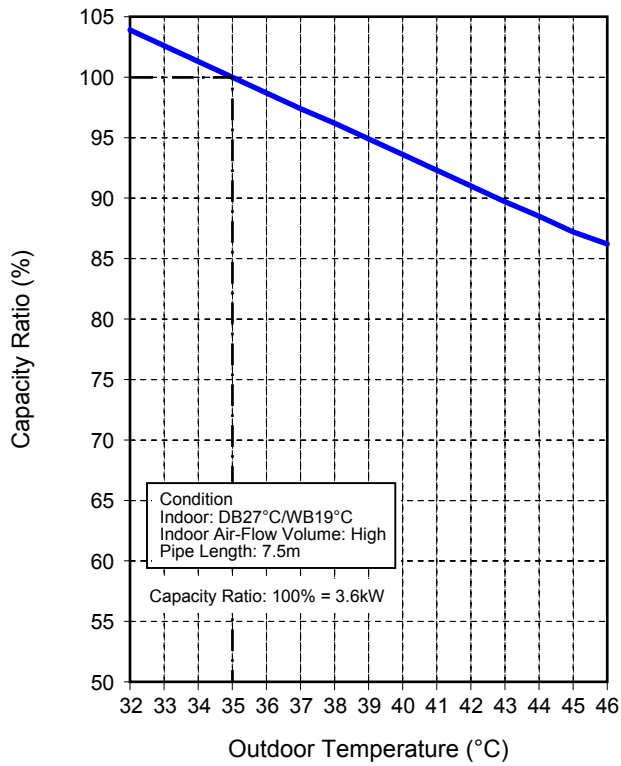

<Heating>

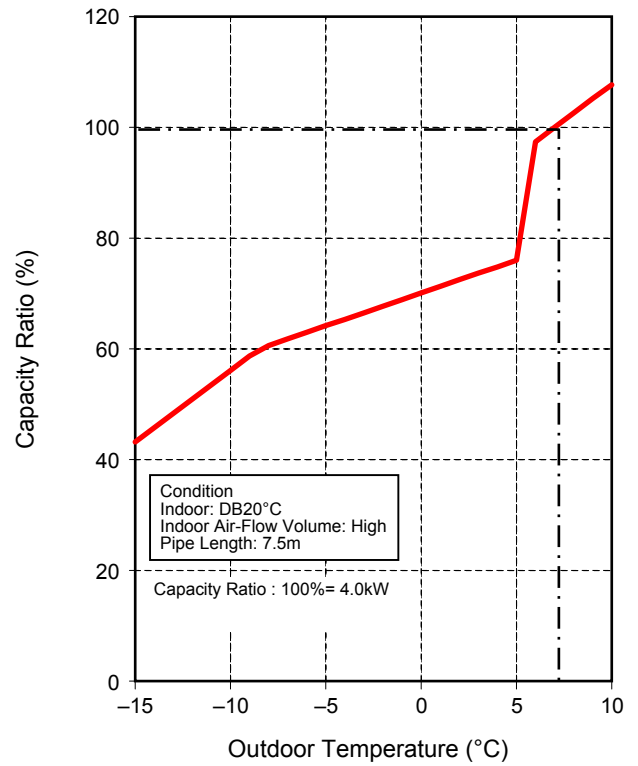

3. SYSTEMATIC REFRIGERATING CYCLE DIAGRAM

3-1. Outdoor Unit

RAV-GM301AT*P*

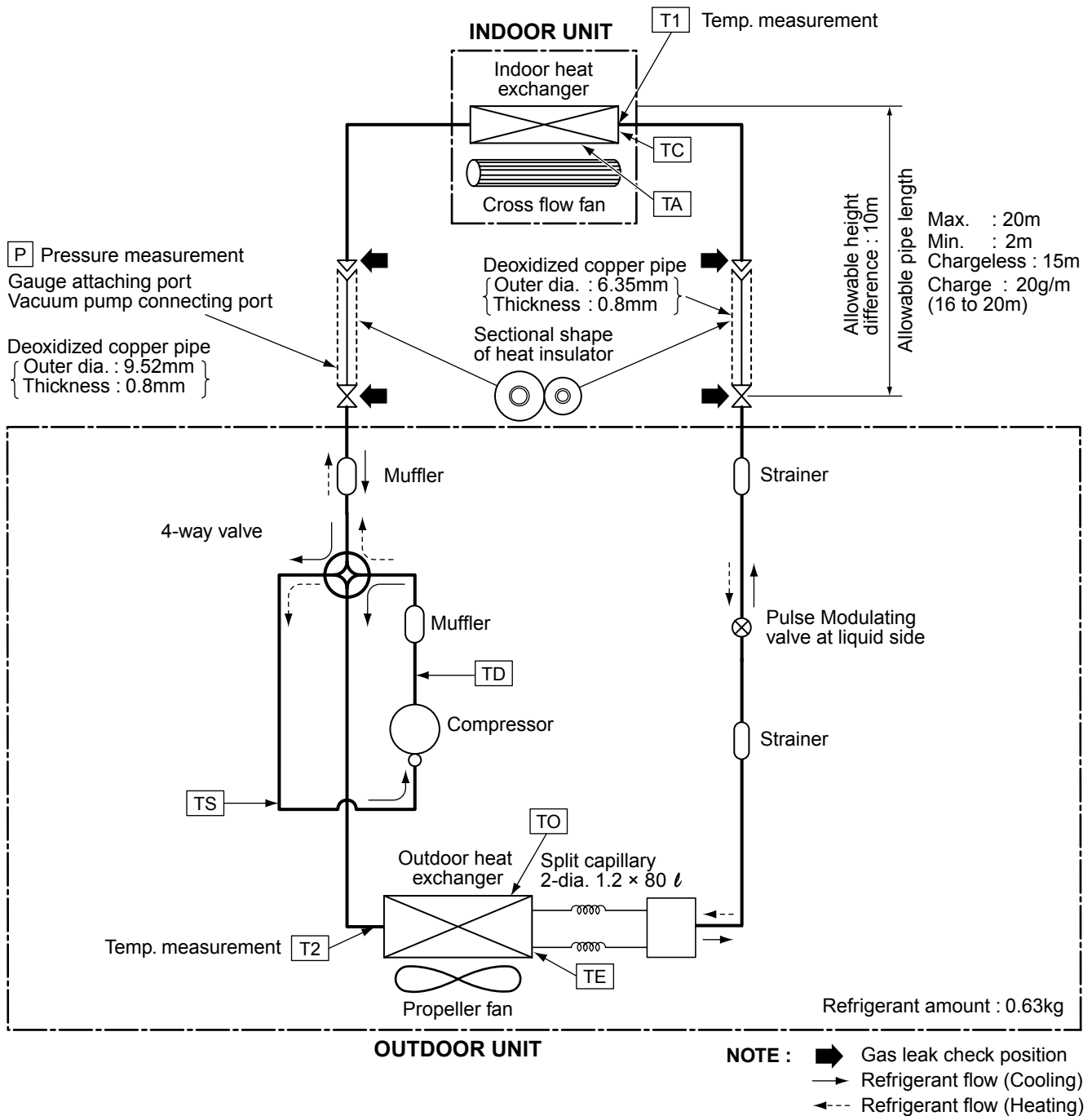

NOTE :

- The maximum pipe length of this air conditioner is 20 m. When the pipe length exceeds 15m, the additional charging of refrigerant, 20g per 1m for the part of pipe exceeded 15m is required. (Max. 100g)

RAV-GM401AT*P*

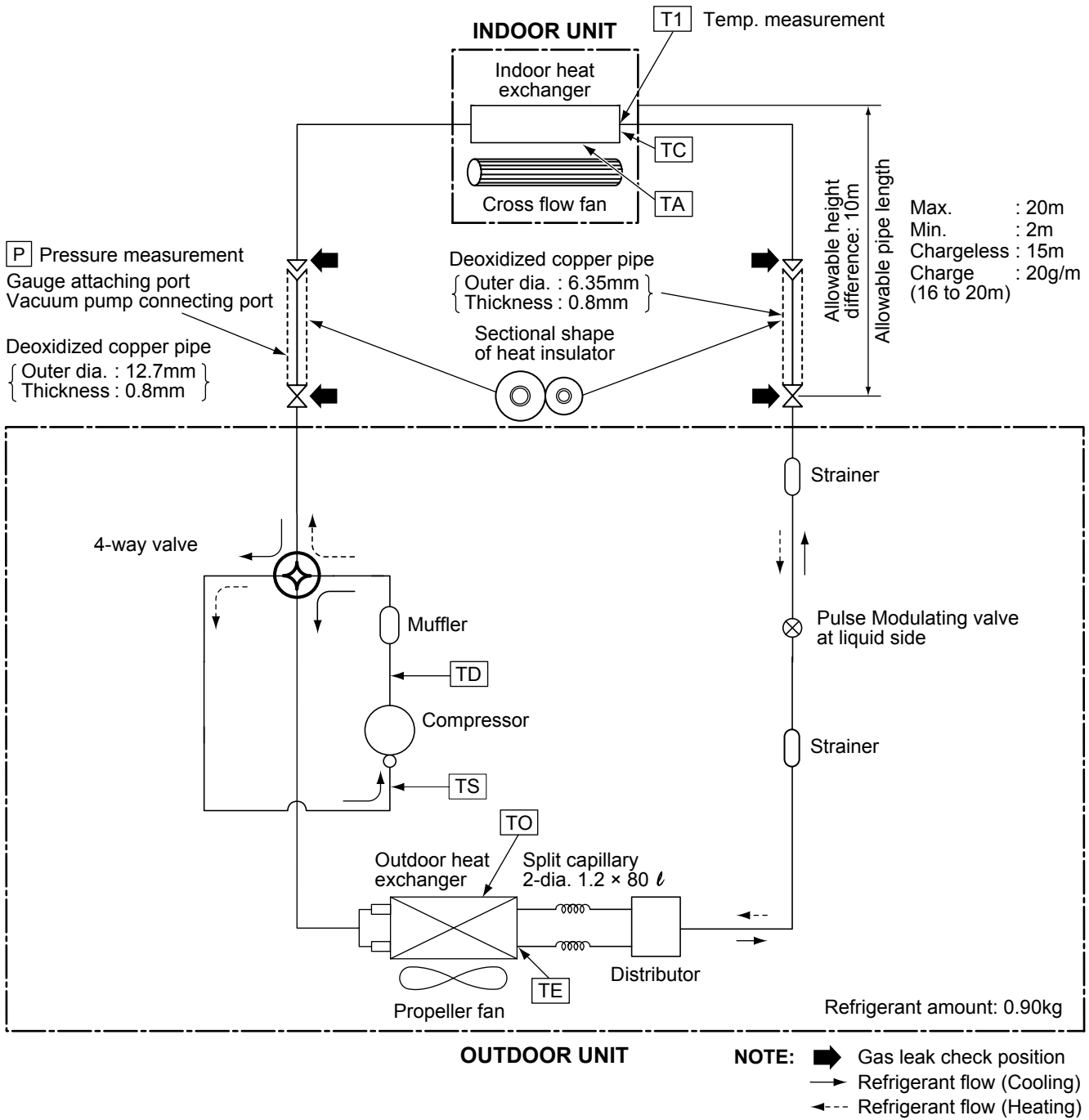

NOTE :

- The maximum pipe length of this air conditioner is 20m. When the pipe length exceeds 15m, the additional charging of refrigerant, 20g per 1m for the part of pipe exceeded 15m is required. (Max. 100g)

3-2. Operation Data

RAV-GM301AT*P*

<Cooling>

Temperature condition(°C)		Standard pressure P (MPa)	Heat exchanger pipe temp.			Indoor fan mode	Outdoor fan mode	Compressor revolution (rps)
Indoor	Outdoor		TC (°C)	TS (°C)	TE (°C)			
27/19	35/-	0.9 to 1.1	13 to 15	13 to 15	37 to 41	High	High	46

<Heating>

Temperature condition(°C)		Standard pressure P (MPa)	Heat exchanger pipe temp.			Indoor fan mode	Outdoor fan mode	Compressor revolution (rps)
Indoor	Outdoor		TC (°C)	TS (°C)	TE (°C)			
20/-	7/6	2.5 to 2.7	35 to 37	5 to 6	3 to 5	High	High	74

RAV-GM401AT*P*

<Cooling>

Temperature condition(°C)		Standard pressure P (MPa)	Heat exchanger pipe temp.			Indoor fan mode	Outdoor fan mode	Compressor revolution (rps)
Indoor	Outdoor		TC (°C)	TS (°C)	TE (°C)			
27/19	35/-	0.9 to 1.1	11 to 13	11 to 13	39 to 42	High	High	51

<Heating>

Temperature condition(°C)		Standard pressure P (MPa)	Heat exchanger pipe temp.			Indoor fan mode	Outdoor fan mode	Compressor revolution (rps)
Indoor	Outdoor		TC (°C)	TS (°C)	TE (°C)			
20/-	7/6	2.5 to 2.6	35 to 42	4 to 6	3 to 5	High	High	53

5. SPECIFICATIONS OF ELECTRICAL PARTS

RAV-GM301AT*P*

No.	Parts name	Type	Specifications
1	Compressor	KSK89D53UFZ	3 phase, 6P, 712W
2	Fan motor	WDF-340-A43-1	Output 43 W
3	4-way valve coil	SQ-A2522G-00352	-
4	PMV coil	PQ-M10012-000313	-
5	Reactor	CH-69-Z-T	19mH, 10A
6	P.C. board	WP-030	-
7	Fuse (Mounted on P.C. board)	-	AC250 V, 25 A
8	Fuse	-	AC250 V, 6.3 A
9	Fuse (Mounted on P.C. board)	-	AC250 V, 3.15 A
10	Outdoor temp. sensor (TO sensor)	-	10 kΩ at 25°C
11	Heat exchanger temp. sensor (TE sensor)	-	10 kΩ at 25°C
12	Suction temp. sensor (TS sensor)	-	10 kΩ at 25°C
13	Discharge temp. sensor (TD sensor)	-	3.3 kΩ at 100°C

RAV-GM401AT*P*

No.	Parts name	Type	Specifications
1	Compressor	KTN130D30UFZ	3 phase, 6P, 1075W
2	Fan motor	WDF-340-A43-1	Output 43 W
3	4-way valve coil	SQ-A2522G-000352	-
4	PMV coil	PQ-M10012-000313	-
5	Reactor	CH-69-Z-T	19mH, 10A
6	P.C. board	WP-030	-
7	Fuse (Mounted on P.C. board)	-	AC250 V, 25 A
8	Fuse	-	AC250 V, 6.3 A
9	Fuse (Mounted on P.C. board)	-	AC250 V, 3.15 A
10	Outdoor temp. sensor (TO sensor)	-	10 kΩ at 25°C
11	Heat exchanger temp. sensor (TE sensor)	-	10 kΩ at 25°C
12	Suction temp. sensor (TS sensor)	-	10 kΩ at 25°C
13	Discharge temp. sensor (TD sensor)	-	3.3 kΩ at 100°C

6. REFRIGERANT R32

This air conditioner adopted the R32 refrigerant which does not damage the ozone layer.

The working pressure of the refrigerant R32 is 1.6 times higher than conventional refrigerant (R22). The refrigerating oil is also changed in accordance with change of refrigerant, so be careful that water, dust, and existing refrigerant or refrigerating oil are not entered in the refrigerant cycle of the air conditioner using the new refrigerant during installation work or servicing time.

The next section describes the precautions for air conditioner using the refrigerant.

Conforming to contents of the next section together with the general cautions included in this manual, perform the correct and safe work.

6-1. Safety During Installation/Service

As R32's pressure is about 1.6 times higher than that of R22, improper installation/servicing may cause a serious trouble. By using tools and materials exclusive for R32, it is necessary to carry out installation/servicing safely while taking the following precautions into consideration.

1. Never use refrigerant other than R32 in an air conditioner which is designed to operate with R32.
If other refrigerant than R32 is mixed, pressure in the refrigeration cycle becomes abnormally high, and it may cause personal injury, etc. by a rupture.
2. Confirm the used refrigerant name, and use tools and materials exclusive for the refrigerant R32. The refrigerant name R32 is indicated on the visible place of the outdoor unit of the air conditioner using R32 as refrigerant. A diameter of charge port for R32 is the same as that of the R410's. Be careful not to charge the refrigerant by mistake.
3. If a refrigeration gas leakage occurs during installation/servicing, be sure to ventilate fully. If the refrigerant gas comes into contact with fire, a poisonous gas may occur.
4. When installing or removing an air conditioner, do not allow air or moisture to remain in the refrigeration cycle.
Otherwise, pressure in the refrigeration cycle may become abnormally high so that a rupture or personal injury may be caused.
5. After completion of installation work, check to make sure that there is no refrigeration gas leakage.
If the refrigerant gas leaks into the room, coming into contact with fire in the fan-driven heater, space heater, etc., a poisonous gas may occur.

6. When an air conditioning system charged with a large volume of refrigerant is installed in a small room, it is necessary to exercise care so that, even when refrigerant leaks, its concentration does not exceed the marginal level.

If the refrigerant gas leakage occurs and its concentration exceeds the marginal level, an oxygen starvation accident may result.

7. Be sure to carry out installation or removal according to the installation manual.
Improper installation may cause refrigeration trouble, water leakage, electric shock, fire, etc.
8. Unauthorized modifications to the air conditioner may be dangerous. If a breakdown occurs please call a qualified air conditioner technician or electrician.
Improper repair may result in water leakage, electric shock and fire, etc.

6-2. Refrigerant Piping Installation

6-2-1. Piping Materials and Joints Used

For the refrigerant piping installation, copper pipes and joints are mainly used.

Copper pipes and joints suitable for the refrigerant must be chosen and installed.

Furthermore, it is necessary to use clean copper pipes and joints whose interior surfaces are less affected by contaminants.

1. Copper Pipes

It is necessary to use seamless copper pipes which are made of either copper or copper alloy and it is desirable that the amount of residual oil is less than 40 mg/10 m.

Do not use copper pipes having a collapsed, deformed or discolored portion (especially on the interior surface).

Otherwise, the expansion valve or capillary tube may become blocked with contaminants.

As an air conditioner using R32 incurs pressure higher than when using R22, it is necessary to choose adequate materials.

Thicknesses of copper pipes used with R32 are as shown in Table 6-2-1. Never use copper pipes thinner than 0.8mm even when it is available on the market.

NOTE:

Refer to the "6-6. Instructions for Re-use Piping of R22 or R407C".

Table 6-2-1 Thicknesses of annealed copper pipes

		Thickness (mm)	
Nominal diameter	Outer diameter (mm)	R32	R22
1/4	6.4	0.80	0.80
3/8	9.5	0.80	0.80
1/2	12.7	0.80	0.80
5/8	15.9	1.00	1.00

1. Joints

For copper pipes, flare joints or socket joints are used. Prior to use, be sure to remove all contaminants.

a) Flare Joints

Flare joints used to connect the copper pipes cannot be used for pipings whose outer diameter exceeds 20 mm. In such a case, socket joints can be used.

Sizes of flare pipe ends, flare joint ends and flare nuts are as shown in Tables 6-2-3 to 6-2-5 below.

b) Socket Joints

Socket joints are such that they are brazed for connections, and used mainly for thick pipings whose diameter is larger than 20 mm. Thicknesses of socket joints are as shown in Table 6-2-2.

Table 6-2-2 Minimum thicknesses of socket joints

Nominal diameter	Reference outer diameter of copper pipe jointed (mm)	Minimum joint thickness (mm)
1/4	6.4	0.50
3/8	9.5	0.60
1/2	12.7	0.70
5/8	15.9	0.80

6-2-2. Processing of Piping Materials

When performing the refrigerant piping installation, care should be taken to ensure that water or dust does not enter the pipe interior, that no other oil other than lubricating oils used in the installed air conditioner is used, and that refrigerant does not leak.

When using lubricating oils in the piping processing, use such lubricating oils whose water content has been removed. When stored, be sure to seal the container with an airtight cap or any other cover.

1. Flare Processing Procedures and Precautions

a) Cutting the Pipe

By means of a pipe cutter, slowly cut the pipe so that it is not deformed.

b) Removing Burrs and Chips

If the flared section has chips or burrs, refrigerant leakage may occur. Carefully remove all burrs and clean the cut surface before installation.

c) Insertion of Flare Nut

d) Flare Processing

Make certain that a clamp bar and copper pipe have been cleaned.

By means of the clamp bar, perform the flare processing correctly.

Use either a flare tool for R410A/R32 or conventional flare tool.

Flare processing dimensions differ according to the type of flare tool.

When using a conventional flare tool, be sure to secure "dimension A" by using a gauge for size adjustment.

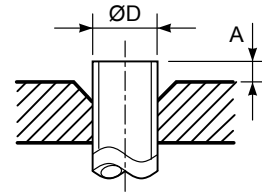

Fig. 6-2-1 Flare processing dimensions

Table 6-2-3 Dimensions related to flare processing for R410A/ R32 / R22

Nominal diameter	Outer diameter (mm)	Thickness (mm)	A (mm)				
			Flare tool for R410A, R22 clutch type	Conventional flare tool (R410A or R32)		Conventional flare tool (R22)	
				Clutch type	Wing nut type	Clutch type	Wing nut type
1/4	6.4	0.8	0 to 0.5	1.0 to 1.5	1.5 to 2.0	0.5 to 1.0	1.0 to 1.5
3/8	9.5	0.8	0 to 0.5	1.0 to 1.5	1.5 to 2.0	0.5 to 1.0	1.0 to 1.5
1/2	12.7	0.8	0 to 0.5	1.0 to 1.5	2.0 to 2.5	0.5 to 1.0	1.5 to 2.0
5/8	15.9	1.0	0 to 0.5	1.0 to 1.5	2.0 to 2.5	0.5 to 1.0	1.5 to 2.0

Table 6-2-4 Flare and flare nut dimensions for R410A/ R32

Nominal diameter	Outer diameter (mm)	Thickness (mm)	Dimension (mm)				Flare nut width (mm)
			A	B	C	D	
1/4	6.4	0.8	9.1	9.2	6.5	13	17
3/8	9.5	0.8	13.2	13.5	9.7	20	22
1/2	12.7	0.8	16.6	16.0	12.9	23	26
5/8	15.9	1.0	19.7	19.0	16.0	25	29

Table 6-2-5 Flare and flare nut dimensions for R22

Nominal diameter	Outer diameter (mm)	Thickness (mm)	Dimension (mm)				Flare nut width (mm)
			A	B	C	D	
1/4	6.4	0.8	9.1	9.2	6.5	13	17
3/8	9.5	0.8	13.0	13.5	9.7	20	22
1/2	12.7	0.8	16.2	16.0	12.9	20	24
5/8	15.9	1.0	19.4	19.0	16.0	23	27
3/4	19.0	1.0	23.3	24.0	19.2	34	36

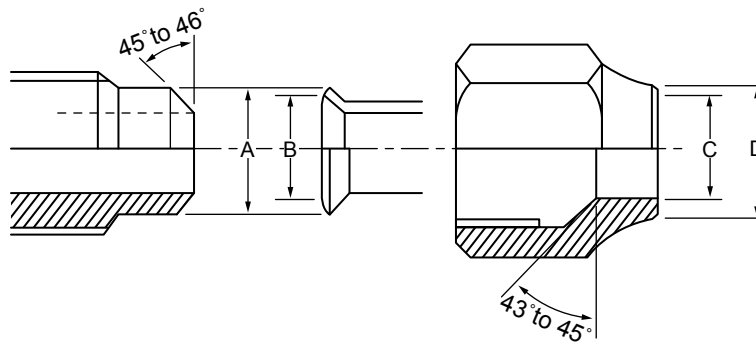

Fig. 6-2-2 Relations between flare nut and flare seal surface

2. Flare Connecting Procedures and Precautions

- a) Make sure that the flare and union portions do not have any scar or dust, etc.
- b) Correctly align the processed flare surface with the union axis.
- c) Tighten the flare with designated torque by means of a torque wrench.

The tightening torque for R410A or R32 is the same as that for conventional R22.

Incidentally, when the torque is weak, the gas leakage may occur.

When it is strong, the flare nut may crack and may be made non-removable.

When choosing the tightening torque, comply with values designated by manufacturers.

Table 6-2-6 shows reference values.

NOTE:

When applying oil to the flare surface, be sure to use oil designated by the manufacturer.

If any other oil is used, the lubricating oils may deteriorate and cause the compressor to burn out.

Table 6-2-6 Tightening torque of flare for R410A or R32 [Reference values]

Nominal diameter	Outer diameter (mm)	Tightening torque N•m (kgf•m)	Tightening torque of torque wrenches available on the market N•m (kgf•m)
1/4	6.4	14 to 18 (1.4 to 1.8)	16 (1.6), 18 (1.8)
3/8	9.5	33 to 42 (3.3 to 4.2)	42 (4.2)
1/2	12.7	50 to 62 (5.0 to 6.2)	55 (5.5)
5/8	15.9	63 to 77 (6.3 to 7.7)	65 (6.5)

6-3. Tools

6-3-1.Required Tools

Refer to the “4. Tools” (Page 13)

6-4. Recharging of Refrigerant

When it is necessary to recharge refrigerant, charge the specified amount of refrigerant according to the following steps.

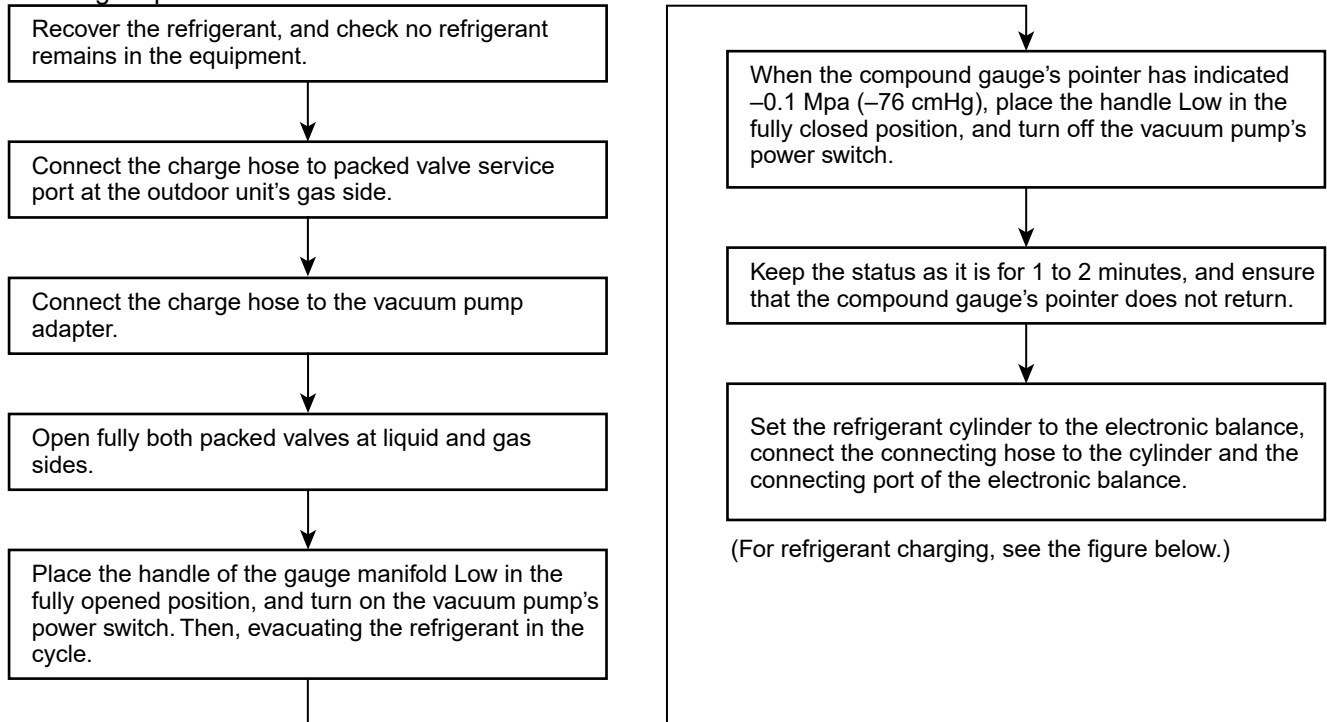

1. Never charge refrigerant exceeding the specified amount.
2. If the specified amount of refrigerant cannot be charged, charge refrigerant **bit by bit** in COOL mode.
3. Do not carry out additional charging.

When additional charging is carried out if refrigerant leaks, the refrigerant composition changes in the refrigeration cycle, that is characteristics of the air conditioner changes, refrigerant exceeding the specified amount is charged, and working pressure in the refrigeration cycle becomes abnormally high pressure, and may cause a rupture or personal injury.

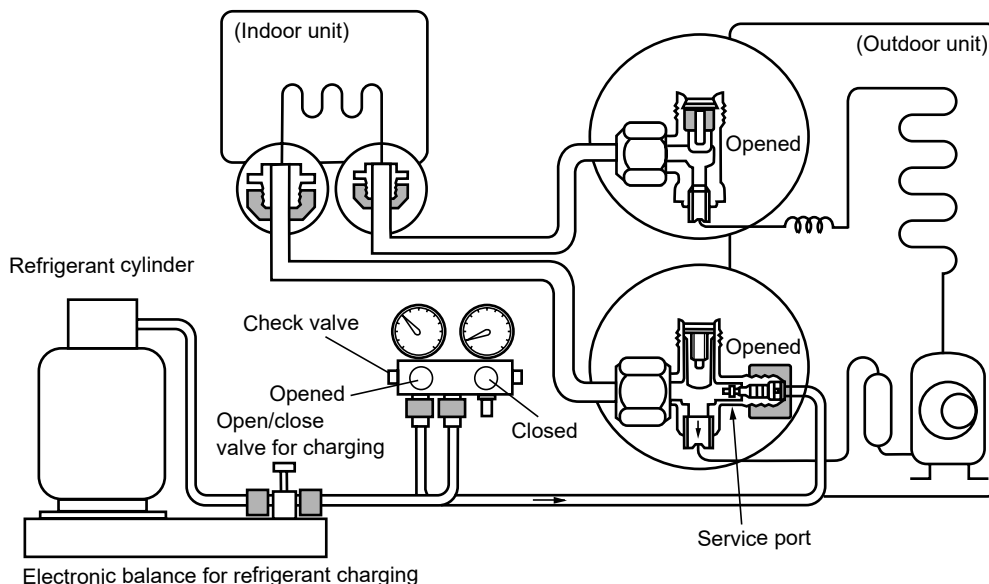

Fig. 6-4-1 Configuration of refrigerant charging

6-5. Brazing of Pipes

6-5-1. Materials for Brazing

1. Silver brazing filler

Silver brazing filler is an alloy mainly composed of silver and copper. It is used to join iron, copper or copper alloy, and is relatively expensive though it excels in solderability.

2. Phosphor bronze brazing filler

Phosphor bronze brazing filler is generally used to join copper or copper alloy.

3. Low temperature brazing filler

Low temperature brazing filler is generally called solder, and is an alloy of tin and lead. Since it is weak in adhesive strength, do not use it for refrigerant pipes.

1. Phosphor bronze brazing filler tends to react with sulfur and produce a fragile compound water solution, which may cause a gas leakage. Therefore, use any other type of brazing filler at a hot spring resort, etc., and coat the surface with a paint.
2. When performing brazing again at time of servicing, use the same type of brazing filler.

6-5-2. Flux

1. Reason why flux is necessary

- By removing the oxide film and any foreign matter on the metal surface, it assists the flow of brazing filler.
- In the brazing process, it prevents the metal surface from being oxidized.
- By reducing the brazing filler's surface tension, the brazing filler adheres better to the treated metal.

2. Characteristics required for flux

- Activated temperature of flux coincides with the brazing temperature.
- Due to a wide effective temperature range, flux is hard to carbonize.
- It is easy to remove slag after brazing.
- The corrosive action to the treated metal and brazing filler is minimum.
- It excels in coating performance and is harmless to the human body.

As the flux works in a complicated manner as described above, it is necessary to select an adequate type of flux according to the type and shape of treated metal, type of brazing filler and brazing method, etc.

3. Types of flux

• Noncorrosive flux

Generally, it is a compound of borax and boric acid.

It is effective in case where the brazing temperature is higher than 800°C.

• Activated flux

Most of fluxes generally used for silver brazing are this type.

It features an increased oxide film removing capability due to the addition of compounds such as potassium fluoride, potassium chloride and sodium fluoride to the borax-boric acid compound.

4. Piping materials for brazing and used brazing filler/flux

Piping material	Used brazing filler	Used flux
Copper - Copper	Phosphor copper	Do not use
Copper - Iron	Silver	Paste flux
Iron - Iron	Silver	Vapor flux

1. Do not enter flux into the refrigeration cycle.
2. When chlorine contained in the flux remains within the pipe, the lubricating oil deteriorates. Therefore, use a flux which does not contain chlorine.
3. When adding water to the flux, use water which does not contain chlorine (e.g. distilled water or ion-exchange water).
4. Remove the flux after brazing.

6-5-3. Brazing

As brazing work requires sophisticated techniques, experiences based upon a theoretical knowledge, it must be performed by a person qualified.

In order to prevent the oxide film from occurring in the pipe interior during brazing, it is effective to proceed with brazing while letting dry Nitrogen gas (N₂) flow.

Never use gas other than Nitrogen gas.

1. Brazing method to prevent oxidation

- 1) Attach a reducing valve and a flow-meter to the Nitrogen gas cylinder.
- 2) Use a copper pipe to direct the piping material, and attach a flow-meter to the cylinder.
- 3) Apply a seal onto the clearance between the piping material and inserted copper pipe for Nitrogen in order to prevent backflow of the Nitrogen gas.
- 4) When the Nitrogen gas is flowing, be sure to keep the piping end open.
- 5) Adjust the flow rate of Nitrogen gas so that it is lower than 0.05 m³/Hr or 0.02 MPa (0.2kgf/cm²) by means of the reducing valve.
- 6) After performing the steps above, keep the Nitrogen gas flowing until the pipe cools down to a certain extent (temperature at which pipes are touchable with hands).
- 7) Remove the flux completely after brazing.

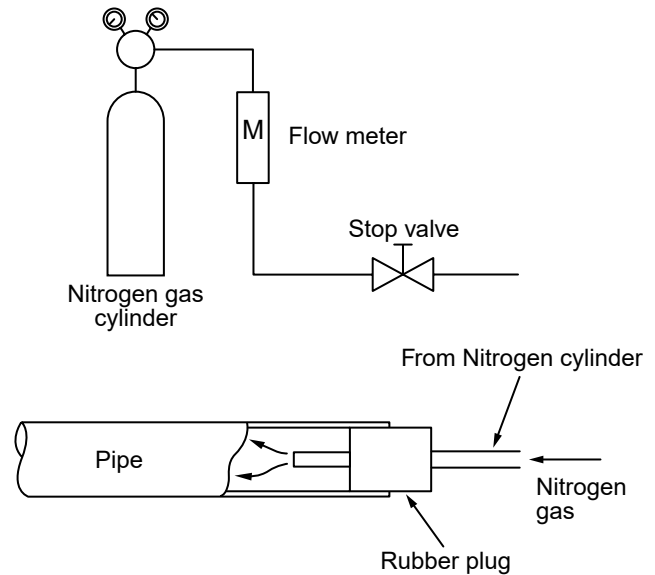
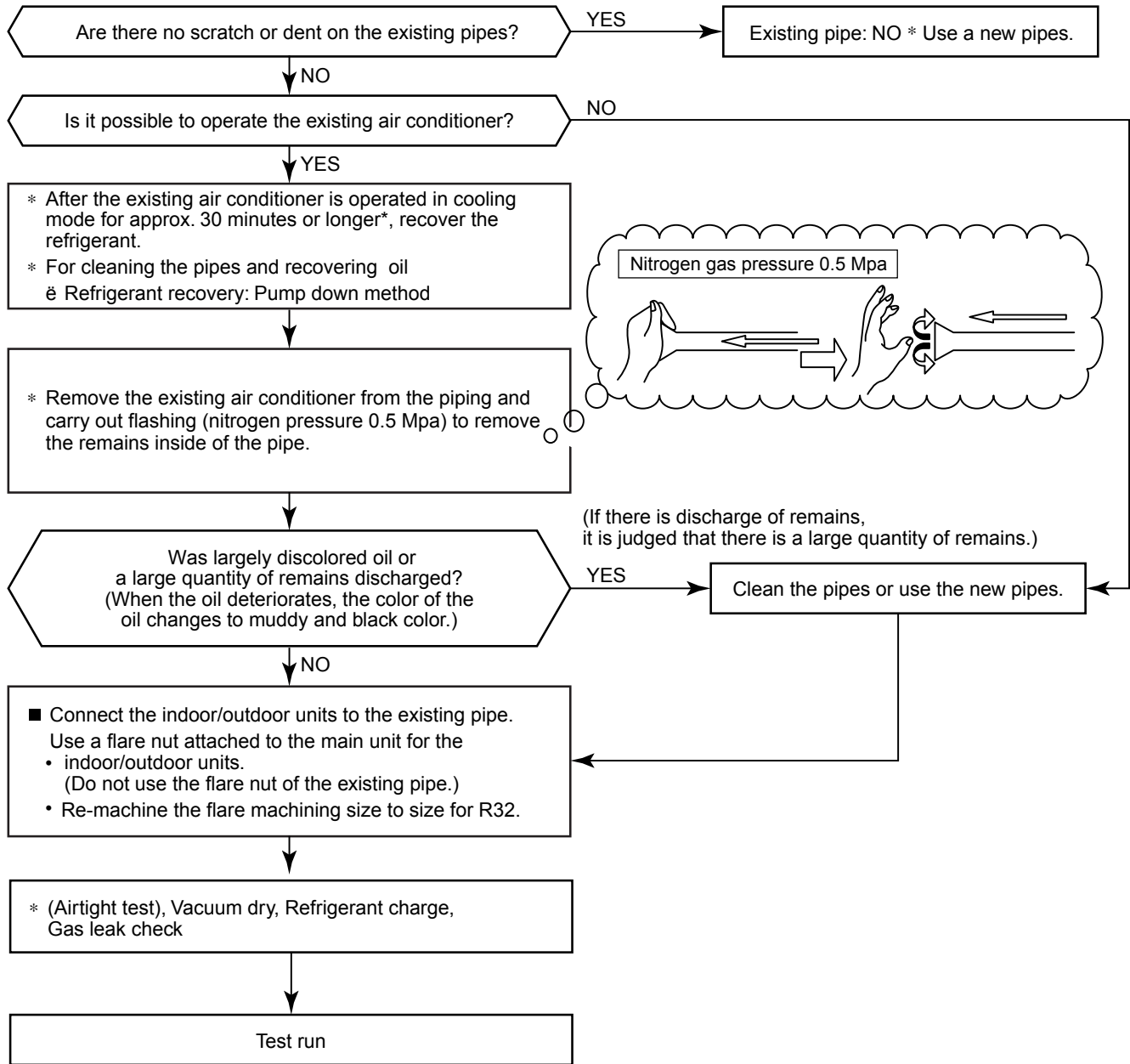

Fig. 6-5-1 Prevention of oxidation during brazing

6-6-4. Final Installation Checks



6-6-5. Handling of Existing Pipe



When using the existing pipe, carefully check it for the following:

- Wall thickness (within the specified range)
- Scratches and dents
- Water, oil, dirt, or dust in the pipe
- Flare looseness and leakage from welds
- Deterioration of copper pipe and heat insulator

Cautions for using existing pipe

- Do not reuse the flare to prevent gas leak.
Replace it with the supplied flare nut and then process it to a flare.
- Blow nitrogen gas or use an appropriate means to keep the inside of the pipe clean.
If discolored oil or much residue is discharged, wash the pipe.
- Check welds, if any, on the pipe for gas leak.
When the pipe corresponds to any of the following, do not use it. Install a new pipe instead.
- The pipe has been open (disconnected from indoor unit or outdoor unit) for a long period.
- The pipe has been connected to an outdoor unit that does not use refrigerant R22, R32 or R407C.
- The existing pipe must have a wall thickness equal to or larger than the following thickness.

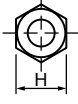
Reference outside diameter (mm)	Wall thickness (mm)
Ø6.4	0.8
Ø9.5	0.8
Ø12.7	0.8

Piping necessary to change the flare nut/ machining size due to pipe compression.						
1) Flare nut width: H (mm)						
	Copper pipe outer dia.	Ø6.4	Ø9.5	Ø12.7	Ø15.9	Ø19.0
	For R410A, R32	17	22	26	29	36
	For R22	Same as above		24	27	Same as above
2) Flare machining size: A (mm)						
	Copper pipe outer dia.	Ø6.4	Ø9.5	Ø12.7	Ø15.9	Ø19.0
	For R410A, R32	9.1	13.2	16.6	19.7	24.0
	For R22	9.0	13.0	16.2	19.4	23.3
Becomes large a little for R410A R32						
Do not apply the refrigerator oil to the flare surface.						

- Never use any pipe with a wall thickness less than these thicknesses due to insufficient pressure capacity.

6-7. Replenishing refrigerant

In order to assure the reliability of the appliance, the amount of refrigerant to be replenished shall be subject to the following restrictions. Follow the margin of excess replenished refrigerant, which is equivalent to the current R22. Otherwise, abnormally high pressure may be generated in the refrigeration cycle, which may result in failure, explosion of the product, or personal injury.

[Possible gas leakage]

Recharging refrigerant is allowed only if it is confirmed that the amount of leakage (e.g. slow leakage upon installation) is within the additional margin specified below.

The amount of leakage is not certain if the product does not function properly (e.g. insufficient cooling / heating performance). In such case, recover the refrigerant and replenish the refrigerant.

[Restrictions for the amount of additional charging]

- a. The amount of refrigerant additionally charged shall not exceed 10% of that specified. If the situation is not solved with such amount, recover the refrigerant completely and charge the specified amount.
- b. In case of slow leakage upon installation and the pipe connection length of not over 15m, further tighten the flare nut or take other effective measures. Do not recharge the refrigerant.

[Cautions for recharging with refrigerant]

- a. Use a scale with an accuracy of at least 10g to recharge the refrigerant. Do not use a bathroom scale.
- b. If the refrigerant leaks, identify the source and make sure to repair it. The refrigerant gas is not hazardous, but if it touches a heat source (e.g. fan heater, stove), a poisonous gas may be generated.
- c. Use liquid refrigerant for replenishment. Replenish the refrigerant carefully and slowly.

6-8 General safety precautions for using R32 refrigerant

6-8-1 Recovery

- When removing refrigerant from a system, either for servicing or decommissioning, it is recommended good practice that all refrigerants are removed safely.
- When transferring refrigerant into cylinders, ensure that only appropriate refrigerant recovery cylinders are employed.
- Ensure that the correct number of cylinders for holding the total system charge are available.
- All cylinders to be used are designated for the recovered refrigerant and labelled for that refrigerant (i.e. special cylinders for the recovery of refrigerant).
- Cylinders shall be complete with pressure relief valve and associated shut-off valves in good working order.
- Empty recovery cylinders are evacuated and, if possible, cooled before recovery occurs.
- The recovery equipment shall be in good working order with a set of instructions concerning the equipment that is at hand and shall be suitable for the recovery of flammable refrigerants.
- in addition, a set of calibrated weighing scales shall be available and in good working order.
- Hoses shall be complete with leak-free disconnect couplings and in good condition.
- Before using recovery machine check that it is satisfactory working order, has been properly maintained and that any associated electrical components are sealed to prevent ignition in the event of a refrigerant release.
- Consult manufacturer if in doubt.
- The recovered refrigerant shall be returned to the refrigerant supplier in the correct recovery cylinder, and the relevant Waste Transfer Note arranged.
- Do not mix refrigerants in recovery units and especially not in cylinders.
- If compressors or compressor oils are to be removed, ensure that they have been evacuated to an acceptable level to make certain that flammable refrigerant does not remain within the lubricant.
- The evacuation process shall be carried out prior to returning the compressor to the suppliers.
- Only electric heating to the compressor body shall be employed to accelerate this process.
- When oil is drained from a system, it shall be carried out safely.

6-8-3 Labelling

- Equipment shall be labelled stating that it has been de-commissioned and emptied of refrigerant.
- The label shall be dated and signed.
- Ensure that are labels on the equipment stating the equipment contains flammable refrigerant.

6-8-2 Decommissioning

- Before carrying out this procedure, it is essential that the technician is completely familiar with the equipment and all its details. Only a qualified installer (* 1) or qualified service person (* 1) is allowed to do this work.
- It is recommended good practice that all refrigerants are recovered safely.
- Prior to the task being carried out, an oil and refrigerant sample shall be taken in case analysis is required prior to re-use of reclaimed refrigerant.
- It is essential that electrical power is available before the task is commenced.

-
- a) Become familiar with the equipment and its operation.
 - b) Isolate system electrically.
 - c) Before attempting the procedure ensure that :
 - mechanical handling equipment is available, if required, for handling refrigerant cylinders;
 - all personal protective equipment is available and being used correctly;
 - the recovery process is supervised at all times by a competent person;
 - recovery equipment and cylinders conform to the appropriate standards.
 - d) Pump down refrigerant system, if possible.
 - e) If a vacuum is not possible, make a manifold so that refrigerant can be removed from the various parts of the system.
 - f) Make sure that cylinder is situated on the scales before recovery takes place.
 - g) Start the recovery machine and operate in accordance with manufacturers instructions.
 - h) Do not overfill cylinders (No more than 80% volume liquid charge).
 - i) Do not exceed the maximum working pressure of the cylinder, even temporarily.
 - j) When the cylinders have been filled correctly and the process complete, make sure that the the cylinders and the equipment are removed from site promptly and all isolation valves on the equipment are closed off.
 - k) Recovered refrigerant shall not be changed into another refrigerant system unless it has been cleaned and checked.
-

7. OUTDOOR CONTROL CIRCUIT

7-1. Outline of Main Controls

1. Pulse Modulating Valve (PMV) control

- 1) For PMV 50 to 500 pulses during operation.
- 2) In cooling operation, PMV is controlled with the temperature difference between TS sensor and TC sensor.
- 3) In heating operation, PMV is controlled with the temperature difference between TS sensor and TE sensor.
- 4) For the temperature difference in items 2) and 3), -1 to 5K is aimed as the target in both cooling and heating operations.

REQUIREMENT

A sensor trouble may cause a liquid back-flow or abnormal overheat resulting in excessive shortening of the compressor life. In a case of trouble on the compressor, be sure to check there is no error in the resistance value and the refrigerating cycle of each sensor after repair and then start the operation.

2. Discharge temperature release control

- 1) When the discharge temperature did not fall or the discharge temperature rapidly went up by PMV control, this control lowers the compressor frequency. It subdivides the frequency control up to 0.6Hz to stabilize the cycle.
- 2) When the discharge temperature detected an abnormal stop zone, the compressor stops and then restarts after 2 minutes 30 seconds.
The error counting is cleared when the operation continued for 10 minutes. If the error is detected by 4 times without clearing, the error is determined and restarting is not performed.
* The cause is considered as excessively little amount of refrigerant, PMV error or clogging of the cycle.
- 3) For displayed contents of error, confirm on the check code list.

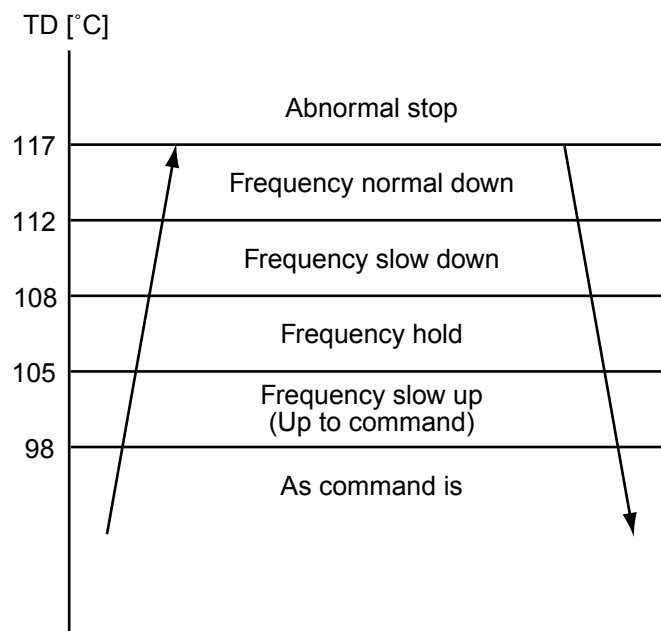

Item	Operation flow and applicable data, etc.	Description																																																																																								
3. Outdoor fan motor control (for GM30)	<p>The blowing air volume at the outdoor unit side is controlled. Receiving the operation command from the controller of indoor unit, the controller of outdoor unit controls fan speed.</p> <p>* For the fan motor, a DC motor with non-stage variable speed system is used. However, it is limited to 8 stages for reasons of controlling.</p>	<ol style="list-style-type: none"> 1) The operation command sent from the remote controller is processed by the indoor unit controller and transferred to the controller of the outdoor unit. 2) When strong wind blows at outdoor side, the operation of air conditioner continues with the fan motor stopped. 3) Whether the fan is locked or not is detected, and the operation of air conditioner stops and an alarm is displayed if the fan is locked. 4) According to each operation mode, by the conditions of outdoor temperature (To) and compressor revolution, the speed of the outdoor fan shown in the table is selected. 																																																																																								
<table border="1"> <thead> <tr> <th colspan="8">In cooling operation</th> </tr> <tr> <th colspan="2" rowspan="2">Compressor speed (rps)</th> <th colspan="2">~ 13.8</th> <th colspan="2">~ 31.7</th> <th colspan="2">32.3 ~ MAX</th> </tr> <tr> <th>MIN</th> <th>MAX</th> <th>MIN</th> <th>MAX</th> <th>MIN</th> <th>MAX</th> </tr> </thead> <tbody> <tr> <td rowspan="6">To</td> <td>To ≥ 38°C</td> <td>f 2</td> <td>f 3</td> <td>f C</td> <td>f D</td> <td>f E</td> <td>f F</td> </tr> <tr> <td>To ≥ 28°C</td> <td>f 2</td> <td>f 3</td> <td>f A</td> <td>f C</td> <td>f D</td> <td>f F</td> </tr> <tr> <td>To ≥ 15°C</td> <td>f 2</td> <td>f 3</td> <td>f 7</td> <td>f A</td> <td>f 9</td> <td>f C</td> </tr> <tr> <td>To ≥ 5.5°C</td> <td>f 1</td> <td>f 3</td> <td>f 2</td> <td>f 5</td> <td>f 4</td> <td>f 7</td> </tr> <tr> <td>To ≥ 0°C</td> <td>f 1</td> <td>f 1</td> <td>f 1</td> <td>f 2</td> <td>f 2</td> <td>f 4</td> </tr> <tr> <td>To < 0°C</td> <td>f 0</td> <td>f 0</td> <td>f 0</td> <td>f 1</td> <td>f 1</td> <td>f 2</td> </tr> <tr> <td rowspan="2">During ECO mode</td> <td>To ≥ 38°C</td> <td>f 2</td> <td>f 3</td> <td>f B</td> <td>f C</td> <td>f C</td> <td>f D</td> </tr> <tr> <td>To < 38°C</td> <td>f 2</td> <td>f 3</td> <td>f 2</td> <td>f 3</td> <td>f B</td> <td>f C</td> </tr> <tr> <td colspan="2">When To is abnormal</td> <td>f D</td> <td>f F</td> <td>f D</td> <td>f F</td> <td>f D</td> <td>f F</td> </tr> </tbody> </table>			In cooling operation								Compressor speed (rps)		~ 13.8		~ 31.7		32.3 ~ MAX		MIN	MAX	MIN	MAX	MIN	MAX	To	To ≥ 38°C	f 2	f 3	f C	f D	f E	f F	To ≥ 28°C	f 2	f 3	f A	f C	f D	f F	To ≥ 15°C	f 2	f 3	f 7	f A	f 9	f C	To ≥ 5.5°C	f 1	f 3	f 2	f 5	f 4	f 7	To ≥ 0°C	f 1	f 1	f 1	f 2	f 2	f 4	To < 0°C	f 0	f 0	f 0	f 1	f 1	f 2	During ECO mode	To ≥ 38°C	f 2	f 3	f B	f C	f C	f D	To < 38°C	f 2	f 3	f 2	f 3	f B	f C	When To is abnormal		f D	f F	f D	f F	f D	f F
In cooling operation																																																																																										
Compressor speed (rps)		~ 13.8		~ 31.7		32.3 ~ MAX																																																																																				
		MIN	MAX	MIN	MAX	MIN	MAX																																																																																			
To	To ≥ 38°C	f 2	f 3	f C	f D	f E	f F																																																																																			
	To ≥ 28°C	f 2	f 3	f A	f C	f D	f F																																																																																			
	To ≥ 15°C	f 2	f 3	f 7	f A	f 9	f C																																																																																			
	To ≥ 5.5°C	f 1	f 3	f 2	f 5	f 4	f 7																																																																																			
	To ≥ 0°C	f 1	f 1	f 1	f 2	f 2	f 4																																																																																			
	To < 0°C	f 0	f 0	f 0	f 1	f 1	f 2																																																																																			
During ECO mode	To ≥ 38°C	f 2	f 3	f B	f C	f C	f D																																																																																			
	To < 38°C	f 2	f 3	f 2	f 3	f B	f C																																																																																			
When To is abnormal		f D	f F	f D	f F	f D	f F																																																																																			
<table border="1"> <thead> <tr> <th colspan="5">In Heating operation</th> </tr> <tr> <th colspan="2">Compressor speed (rps)</th> <th>~16.8</th> <th>~47.9</th> <th>48.5 ~ MAX</th> </tr> </thead> <tbody> <tr> <td rowspan="4">To</td> <td>To ≥ 15°C</td> <td>f 3</td> <td>f 8</td> <td>f 9</td> </tr> <tr> <td>To < 15°C</td> <td>f 3</td> <td>f 9</td> <td>f A</td> </tr> <tr> <td>To < 5.5°C</td> <td>f 8</td> <td>f A</td> <td>f D</td> </tr> <tr> <td>To < -5.0°C</td> <td>f B</td> <td>f C</td> <td>f D</td> </tr> <tr> <td rowspan="3">During ECO mode</td> <td>To ≥ 15°C</td> <td>f 3</td> <td>f 3</td> <td>f 6</td> </tr> <tr> <td>To < 15°C</td> <td>f 3</td> <td>f 3</td> <td>f 8</td> </tr> <tr> <td>To < 5.5°C</td> <td>f 5</td> <td>f 9</td> <td>f 9</td> </tr> <tr> <td colspan="2">When To is abnormal</td> <td>f A</td> <td>f B</td> <td>f D</td> </tr> </tbody> </table>			In Heating operation					Compressor speed (rps)		~16.8	~47.9	48.5 ~ MAX	To	To ≥ 15°C	f 3	f 8	f 9	To < 15°C	f 3	f 9	f A	To < 5.5°C	f 8	f A	f D	To < -5.0°C	f B	f C	f D	During ECO mode	To ≥ 15°C	f 3	f 3	f 6	To < 15°C	f 3	f 3	f 8	To < 5.5°C	f 5	f 9	f 9	When To is abnormal		f A	f B	f D																																											
In Heating operation																																																																																										
Compressor speed (rps)		~16.8	~47.9	48.5 ~ MAX																																																																																						
To	To ≥ 15°C	f 3	f 8	f 9																																																																																						
	To < 15°C	f 3	f 9	f A																																																																																						
	To < 5.5°C	f 8	f A	f D																																																																																						
	To < -5.0°C	f B	f C	f D																																																																																						
During ECO mode	To ≥ 15°C	f 3	f 3	f 6																																																																																						
	To < 15°C	f 3	f 3	f 8																																																																																						
	To < 5.5°C	f 5	f 9	f 9																																																																																						
When To is abnormal		f A	f B	f D																																																																																						
<p>Outdoor fan speed (rpm)</p> <table border="1"> <thead> <tr> <th>Tap</th> <th>GM30</th> </tr> </thead> <tbody> <tr><td>f 0</td><td>0</td></tr> <tr><td>f 1</td><td>200</td></tr> <tr><td>f 2</td><td>300</td></tr> <tr><td>f 3</td><td>370</td></tr> <tr><td>f 4</td><td>440</td></tr> <tr><td>f 5</td><td>440</td></tr> <tr><td>f 6</td><td>500</td></tr> <tr><td>f 7</td><td>550</td></tr> <tr><td>f 8</td><td>600</td></tr> </tbody> </table> <table border="1"> <thead> <tr> <th>Tap</th> <th>GM30</th> </tr> </thead> <tbody> <tr><td>f 9</td><td>600</td></tr> <tr><td>f A</td><td>600</td></tr> <tr><td>f B</td><td>650</td></tr> <tr><td>f C</td><td>700</td></tr> <tr><td>f D</td><td>700</td></tr> <tr><td>f E</td><td>700</td></tr> <tr><td>f F</td><td>700</td></tr> </tbody> </table>			Tap	GM30	f 0	0	f 1	200	f 2	300	f 3	370	f 4	440	f 5	440	f 6	500	f 7	550	f 8	600	Tap	GM30	f 9	600	f A	600	f B	650	f C	700	f D	700	f E	700	f F	700																																																				
Tap	GM30																																																																																									
f 0	0																																																																																									
f 1	200																																																																																									
f 2	300																																																																																									
f 3	370																																																																																									
f 4	440																																																																																									
f 5	440																																																																																									
f 6	500																																																																																									
f 7	550																																																																																									
f 8	600																																																																																									
Tap	GM30																																																																																									
f 9	600																																																																																									
f A	600																																																																																									
f B	650																																																																																									
f C	700																																																																																									
f D	700																																																																																									
f E	700																																																																																									
f F	700																																																																																									

Item	Operation flow and applicable data, etc.	Description																																																																																																																																																																																					
3. Outdoor fan motor control (for SM40)	<p>The blowing air volume at the outdoor unit side is controlled. Receiving the operation command from the controller of indoor unit, the controller of outdoor unit controls fan speed.</p> <p>* For the fan motor, a DC motor with non-stage variable speed system is used. However, it is limited to 8 stages for reasons of controlling.</p> <pre> graph TD A[Air conditioner ON (Remote controller)] --> B[Indoor unit controller] B --> C[1) Outdoor unit operation command (Outdoor fan control)] C --> D{2) Fan speed ≥ 400 when the motor stopped.} D -- YES --> E[OFF status of fan motor continues.] D -- NO --> F[Fan motor ON] F --> G{3) Fan lock} G -- YES --> H[Air conditioner OFF] H --> I[Alarm display] G -- NO --> J[4) Motor operates as shown in the table below.] J --> K[In cooling operation table] J --> L[In Heating operation table] </pre> <table border="1" data-bbox="198 1258 854 1740"> <caption>In cooling operation</caption> <thead> <tr> <th colspan="2" rowspan="2"></th> <th colspan="2">< 22.1</th> <th colspan="2">< 50.3</th> <th colspan="2">50.3 ≤</th> </tr> <tr> <th>MIN</th> <th>MAX</th> <th>MIN</th> <th>MAX</th> <th>MIN</th> <th>MAX</th> </tr> </thead> <tbody> <tr> <td rowspan="6">To</td> <td>To ≥ 38°C</td> <td>f 6</td> <td>f 9</td> <td>f 8</td> <td>f B</td> <td>f A</td> <td>f E</td> </tr> <tr> <td>To ≥ 28°C</td> <td>f 5</td> <td>f 9</td> <td>f 7</td> <td>f B</td> <td>f 9</td> <td>f E</td> </tr> <tr> <td>To ≥ 15°C</td> <td>f 3</td> <td>f 7</td> <td>f 5</td> <td>f 9</td> <td>f 7</td> <td>f B</td> </tr> <tr> <td>To ≥ 5.5°C</td> <td>f 1</td> <td>f 3</td> <td>f 1</td> <td>f 7</td> <td>f 3</td> <td>f 9</td> </tr> <tr> <td>To ≥ 0°C</td> <td>f 1</td> <td>f 3</td> <td>f 1</td> <td>f 5</td> <td>f 3</td> <td>f 7</td> </tr> <tr> <td>To ≥ -5°C</td> <td>f 0</td> <td>f 1</td> <td>f 0</td> <td>f 3</td> <td>f 1</td> <td>f 4</td> </tr> <tr> <td rowspan="6">During ECO, QUIET and comfort sleep</td> <td>To ≥ 38°C</td> <td>f 6</td> <td>f 9</td> <td>f 8</td> <td>f B</td> <td>f A</td> <td>f B</td> </tr> <tr> <td>To ≥ 28°C</td> <td>f 5</td> <td>f 9</td> <td>f 7</td> <td>f B</td> <td>f 9</td> <td>f B</td> </tr> <tr> <td>To ≥ 15°C</td> <td>f 3</td> <td>f 7</td> <td>f 5</td> <td>f 9</td> <td>f 7</td> <td>f B</td> </tr> <tr> <td>To ≥ 5.5°C</td> <td>f 1</td> <td>f 3</td> <td>f 1</td> <td>f 7</td> <td>f 3</td> <td>f 9</td> </tr> <tr> <td>To ≥ 0°C</td> <td>f 1</td> <td>f 3</td> <td>f 1</td> <td>f 5</td> <td>f 3</td> <td>f 7</td> </tr> <tr> <td>To ≥ -5°C</td> <td>f 0</td> <td>f 1</td> <td>f 0</td> <td>f 3</td> <td>f 1</td> <td>f 4</td> </tr> <tr> <td colspan="2">When To is abnormal</td> <td>f 1</td> <td>f F</td> <td>f 1</td> <td>f F</td> <td>f 1</td> <td>f F</td> </tr> </tbody> </table> <table border="1" data-bbox="894 1258 1446 1591"> <caption>In Heating operation</caption> <thead> <tr> <th colspan="2" rowspan="2"></th> <th colspan="2">< 30.5</th> <th colspan="2">< 55.1</th> <th colspan="2">55.1 ≤</th> </tr> <tr> <th>MIN</th> <th>MAX</th> <th>MIN</th> <th>MAX</th> <th>MIN</th> <th>MAX</th> </tr> </thead> <tbody> <tr> <td rowspan="4">To</td> <td>To ≥ 10°C</td> <td>f 6</td> <td>f 8</td> <td>f 8</td> <td>f 9</td> <td>f 9</td> <td>f 9</td> </tr> <tr> <td>To ≥ 5.5°C</td> <td>f 8</td> <td>f A</td> <td>f A</td> <td>f C</td> <td>f C</td> <td>f C</td> </tr> <tr> <td>To ≥ -5°C</td> <td>f A</td> <td>f B</td> <td>f B</td> <td>f D</td> <td>f D</td> <td>f D</td> </tr> <tr> <td>To < -5°C</td> <td>f A</td> <td>f B</td> <td>f B</td> <td>f D</td> <td>f D</td> <td>f D</td> </tr> <tr> <td rowspan="3">During ECO mode</td> <td>To ≥ 10°C</td> <td>f 5</td> <td>f 7</td> <td>f 7</td> <td>f 9</td> <td>f 9</td> <td>f 9</td> </tr> <tr> <td>To ≥ 5.5°C</td> <td>f 7</td> <td>f 9</td> <td>f 9</td> <td>f B</td> <td>f B</td> <td>f B</td> </tr> <tr> <td>To ≥ -5°C</td> <td>f 9</td> <td>f A</td> <td>f A</td> <td>f B</td> <td>f B</td> <td>f B</td> </tr> <tr> <td colspan="2">When To is abnormal</td> <td>f D</td> <td>f D</td> <td>f D</td> <td>f D</td> <td>f D</td> <td>f D</td> </tr> </tbody> </table>			< 22.1		< 50.3		50.3 ≤		MIN	MAX	MIN	MAX	MIN	MAX	To	To ≥ 38°C	f 6	f 9	f 8	f B	f A	f E	To ≥ 28°C	f 5	f 9	f 7	f B	f 9	f E	To ≥ 15°C	f 3	f 7	f 5	f 9	f 7	f B	To ≥ 5.5°C	f 1	f 3	f 1	f 7	f 3	f 9	To ≥ 0°C	f 1	f 3	f 1	f 5	f 3	f 7	To ≥ -5°C	f 0	f 1	f 0	f 3	f 1	f 4	During ECO, QUIET and comfort sleep	To ≥ 38°C	f 6	f 9	f 8	f B	f A	f B	To ≥ 28°C	f 5	f 9	f 7	f B	f 9	f B	To ≥ 15°C	f 3	f 7	f 5	f 9	f 7	f B	To ≥ 5.5°C	f 1	f 3	f 1	f 7	f 3	f 9	To ≥ 0°C	f 1	f 3	f 1	f 5	f 3	f 7	To ≥ -5°C	f 0	f 1	f 0	f 3	f 1	f 4	When To is abnormal		f 1	f F	f 1	f F	f 1	f F			< 30.5		< 55.1		55.1 ≤		MIN	MAX	MIN	MAX	MIN	MAX	To	To ≥ 10°C	f 6	f 8	f 8	f 9	f 9	f 9	To ≥ 5.5°C	f 8	f A	f A	f C	f C	f C	To ≥ -5°C	f A	f B	f B	f D	f D	f D	To < -5°C	f A	f B	f B	f D	f D	f D	During ECO mode	To ≥ 10°C	f 5	f 7	f 7	f 9	f 9	f 9	To ≥ 5.5°C	f 7	f 9	f 9	f B	f B	f B	To ≥ -5°C	f 9	f A	f A	f B	f B	f B	When To is abnormal		f D	f D	f D	f D	f D	f D	<ol style="list-style-type: none"> The operation command sent from the remote controller is processed by the indoor unit controller and transferred to the controller of the outdoor unit. When strong wind blows at outdoor side, the operation of air conditioner continues with the fan motor stopped. Whether the fan is locked or not is detected, and the operation of air conditioner stops and an alarm is displayed if the fan is locked. According to each operation mode, by the conditions of outdoor temperature (To) and compressor revolution, the speed of the outdoor fan shown in the table is selected.
				< 22.1		< 50.3		50.3 ≤																																																																																																																																																																															
		MIN	MAX	MIN	MAX	MIN	MAX																																																																																																																																																																																
To	To ≥ 38°C	f 6	f 9	f 8	f B	f A	f E																																																																																																																																																																																
	To ≥ 28°C	f 5	f 9	f 7	f B	f 9	f E																																																																																																																																																																																
	To ≥ 15°C	f 3	f 7	f 5	f 9	f 7	f B																																																																																																																																																																																
	To ≥ 5.5°C	f 1	f 3	f 1	f 7	f 3	f 9																																																																																																																																																																																
	To ≥ 0°C	f 1	f 3	f 1	f 5	f 3	f 7																																																																																																																																																																																
	To ≥ -5°C	f 0	f 1	f 0	f 3	f 1	f 4																																																																																																																																																																																
During ECO, QUIET and comfort sleep	To ≥ 38°C	f 6	f 9	f 8	f B	f A	f B																																																																																																																																																																																
	To ≥ 28°C	f 5	f 9	f 7	f B	f 9	f B																																																																																																																																																																																
	To ≥ 15°C	f 3	f 7	f 5	f 9	f 7	f B																																																																																																																																																																																
	To ≥ 5.5°C	f 1	f 3	f 1	f 7	f 3	f 9																																																																																																																																																																																
	To ≥ 0°C	f 1	f 3	f 1	f 5	f 3	f 7																																																																																																																																																																																
	To ≥ -5°C	f 0	f 1	f 0	f 3	f 1	f 4																																																																																																																																																																																
When To is abnormal		f 1	f F	f 1	f F	f 1	f F																																																																																																																																																																																
		< 30.5		< 55.1		55.1 ≤																																																																																																																																																																																	
		MIN	MAX	MIN	MAX	MIN	MAX																																																																																																																																																																																
To	To ≥ 10°C	f 6	f 8	f 8	f 9	f 9	f 9																																																																																																																																																																																
	To ≥ 5.5°C	f 8	f A	f A	f C	f C	f C																																																																																																																																																																																
	To ≥ -5°C	f A	f B	f B	f D	f D	f D																																																																																																																																																																																
	To < -5°C	f A	f B	f B	f D	f D	f D																																																																																																																																																																																
During ECO mode	To ≥ 10°C	f 5	f 7	f 7	f 9	f 9	f 9																																																																																																																																																																																
	To ≥ 5.5°C	f 7	f 9	f 9	f B	f B	f B																																																																																																																																																																																
	To ≥ -5°C	f 9	f A	f A	f B	f B	f B																																																																																																																																																																																
When To is abnormal		f D	f D	f D	f D	f D	f D																																																																																																																																																																																

Tab	GM40
f 0	0
f 1	230
f 2	300
f 3	350
f 4	410
f 5	480
f 6	500
f 7	530

Tab	GM40
f 8	560
f 9	640
f A	670
f B	700
f C	800
f D	800
f E	900
f F	900

Item	Operation flow and applicable data, etc.	Description																				
<p>4. Capacity control</p>	<p>The cooling or heating capacity depending on the load is adjusted.</p> <p>According to difference between the setup value of temperature and the room temperature, the capacity is adjusted by the compressor revolution.</p> <div style="text-align: center;"> <pre> graph TD subgraph Remote_controller [Remote controller] Ts[Set temp. (Ts)] end subgraph Indoor_unit [Indoor unit] Ta[Room temp. (Ta)] end Ts --> Diff{Ts - Ta} Ta --> Diff Diff --> Hz[Correction of Hz signal] Hz --> EMF[Detection of electromotive force of compressor motor winding] EMF --> Speed[Detection of motor speed and rotor position] Speed --> Decision{Correction value of Hz signal ≤ Operating Hz} Decision --> Inverter[Inverter output change Commutation timing change] Inverter --> SpeedChange[Change of compressor speed] </pre> </div>	<ol style="list-style-type: none"> 1) The difference between set temperature on remote controller (Ts) and room temperature (Ta) is calculated. 2) According to the temperature difference, the correction value of Hz signal which determines the compressor speed is set up. 3) The rotating position and speed of the motor are detected by the electromotive force occurred on the motor winding with operation of the compressor. 4) According to the difference resulted from comparison of the correction value of Hz signal with the present operation Hz, the inverter output and the commutation timing are varied. 5) Change the compressor motor speed by outputting power to the compressor. <p>* The contents of control operation are same in cooling operation and heating operation</p>																				
<p>5. Current release control</p>	<p>This function prevents troubles on the electronic parts of the compressor driving inverter.</p> <p>This function also controls drive circuit of the compressor speed so that electric power of the compressor drive circuit does not exceed the specified value.</p> <div style="text-align: center;"> <pre> graph TD Inverter[Outdoor unit inverter main circuit control current] --> Decision{Operating current ≤ Setup value} Temp[Outdoor temp. To] --> Setup[Setup of current release point] Setup --> Decision Decision -- No --> Reduce[Reduce compressor speed] Reduce --> Decrease{Current decrease} Decrease --> Continue[Capacity control continues.] Decision -- Yes --> Continue </pre> </div> <table border="1" style="width: 100%; border-collapse: collapse; text-align: center;"> <thead> <tr> <th rowspan="2">Outdoor temp.</th> <th colspan="2">Cooling current release value</th> <th colspan="2">Heating current release value</th> </tr> <tr> <th>GM30</th> <th>GM40</th> <th>GM30</th> <th>GM40</th> </tr> </thead> <tbody> <tr> <td>45°C</td> <td rowspan="2">5.8A</td> <td rowspan="2">6.2A</td> <td rowspan="5">7.0A</td> <td rowspan="5">8.0A</td> </tr> <tr> <td>40°C</td> </tr> <tr> <td>16°C</td> <td rowspan="3">6.4A</td> <td rowspan="3">9.1A</td> </tr> <tr> <td>11°C</td> </tr> <tr> <td>10.5°C</td> </tr> </tbody> </table>	Outdoor temp.	Cooling current release value		Heating current release value		GM30	GM40	GM30	GM40	45°C	5.8A	6.2A	7.0A	8.0A	40°C	16°C	6.4A	9.1A	11°C	10.5°C	<ol style="list-style-type: none"> 1) The input current of the outdoor unit is detected in the inverter section of the outdoor unit. 2) According to the detected outdoor temperature, the specified value of the current is selected. 3) Whether the current value exceeds the specified value or not is judged. 4) If the current value exceeds the specified value, this function reduces the compressor speed and controls speed up to the closest one commanded from the indoor unit within the range which does not exceed the specified value.
Outdoor temp.	Cooling current release value		Heating current release value																			
	GM30	GM40	GM30	GM40																		
45°C	5.8A	6.2A	7.0A	8.0A																		
40°C																						
16°C	6.4A	9.1A																				
11°C																						
10.5°C																						

Item	Operation flow and applicable data, etc.	Description
<p>6. Release protective control by temperature of indoor heat exchanger</p>	<p><In cooling/dry operation> (Prevent-freezing control for indoor heat exchanger) In cooling/dry operation, the sensor of indoor heat exchanger detects evaporation temperature and controls the compressor speed so that temperature of the heat exchanger does not exceed the specified value.</p>	<ol style="list-style-type: none"> 1) When temperature of the indoor heat exchanger drops below 5°C, the compressor speed is reduced. (P zone) 2) When temperature of the indoor heat exchanger rises in the range from 6°C to under 7°C, the compressor speed is kept. (Q zone) 3) When temperature of the indoor heat exchanger rises to 7°C or higher, the capacity control operation returns to the usual control in cooling operation. (R zone)
	<p><In heating operation> (Prevent-overpressure control for refrigerating cycle) In heating operation, the sensor of indoor heat exchanger detects condensation temperature and controls the compressor speed so that temperature of the heat exchanger does not exceed the specified value.</p>	<ol style="list-style-type: none"> 1) When temperature of the indoor heat exchanger rises in the range from 52°C to 55°C, the compressor speed is kept. (Q zone) 2) When temperature of the indoor heat exchanger rises to 55°C or higher, the compressor speed is reduced. (P zone) 3) When temperature of the indoor heat exchanger drops in the range from 55°C to under 48°C, the compressor speed is kept. (Q zone) 4) When temperature of the indoor heat exchanger does not rise to 52°C, or when it drops below to 48°C, the capacity control operation returns to the usual control in heating operation. (R zone)

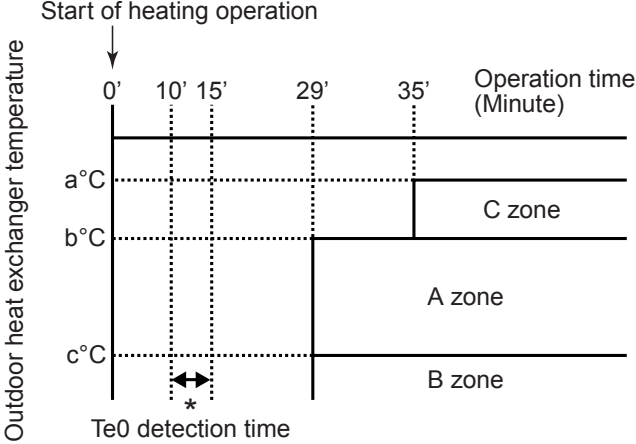
Item	Operation flow and applicable data, etc.	Description																		
<p>7. Defrost control (Only in heating operation)</p>	<p>(This function removes frost adhered to the outdoor heat exchanger.)</p> <p>The temperature sensor of the outdoor heat exchanger (Te sensor) judges the frosting status of the outdoor heat exchanger and the defrost operation is performed with 4-way valve reverse defrost system.</p>  <table border="1" data-bbox="177 945 868 1155"> <thead> <tr> <th>Model</th> <th>a</th> <th>b</th> <th>c</th> </tr> </thead> <tbody> <tr> <td>GM30</td> <td>-5</td> <td>-7</td> <td>-20</td> </tr> <tr> <td>GM40</td> <td>-3</td> <td>-7</td> <td>-26</td> </tr> </tbody> </table> <p>* The minimum value of Te sensor 10 to 15 minutes after start of operation is stored in memory as Te0.</p> <p style="text-align: center;">Table 1</p> <table border="1" data-bbox="169 1319 936 1529"> <tbody> <tr> <td>A zone</td> <td>When $Te_0 - TE \geq 2.5$ continued for 2 minutes in A zone, defrost operation starts.</td> </tr> <tr> <td>B zone</td> <td>When the operation continued for 2 minutes in B zone, defrost operation starts.</td> </tr> <tr> <td>C zone</td> <td>When $Te_0 - TE \geq 3$ continued for 2 minutes in C zone, defrost operation starts.</td> </tr> </tbody> </table>	Model	a	b	c	GM30	-5	-7	-20	GM40	-3	-7	-26	A zone	When $Te_0 - TE \geq 2.5$ continued for 2 minutes in A zone, defrost operation starts.	B zone	When the operation continued for 2 minutes in B zone, defrost operation starts.	C zone	When $Te_0 - TE \geq 3$ continued for 2 minutes in C zone, defrost operation starts.	<p>The necessity of defrost operation is detected by the outdoor heat exchanger temperature. The conditions to detect the necessity of defrost operation differ in A, B, or C zone each. (Table 1)</p> <p><Defrost operation></p> <ul style="list-style-type: none"> Defrost operation in A to C zones <ol style="list-style-type: none"> 1) Stop operation of the compressor for 20 seconds. 2) Invert (ON) 4-way valve 10 seconds after stop of the compressor. 3) The outdoor fan stops at the same time when the compressor stops. 4) When temperature of the indoor heat exchanger becomes 38°C or lower, stop the indoor fan. <p><Finish of defrost operation></p> <ul style="list-style-type: none"> Returning conditions from defrost operation to heating operation <ol style="list-style-type: none"> 1) Temperature of outdoor heat exchanger rises to +8°C or higher. 2) Temperature of outdoor heat exchanger is kept at +5°C or higher for 80 seconds. 3) Defrost operation continues for 15 minutes. <p><Returning from defrost operation></p> <ol style="list-style-type: none"> 1) Stop operation of the compressor for approx. 50 seconds. 2) Invert (OFF) 4-way valve approx. 40 seconds after stop of the compressor. 3) The outdoor fan starts rotating at the same time when the compressor starts.
Model	a	b	c																	
GM30	-5	-7	-20																	
GM40	-3	-7	-26																	
A zone	When $Te_0 - TE \geq 2.5$ continued for 2 minutes in A zone, defrost operation starts.																			
B zone	When the operation continued for 2 minutes in B zone, defrost operation starts.																			
C zone	When $Te_0 - TE \geq 3$ continued for 2 minutes in C zone, defrost operation starts.																			

7-2. Outdoor Print Circuit Board

RAV-GM301AT*P*, GM401AT*P*

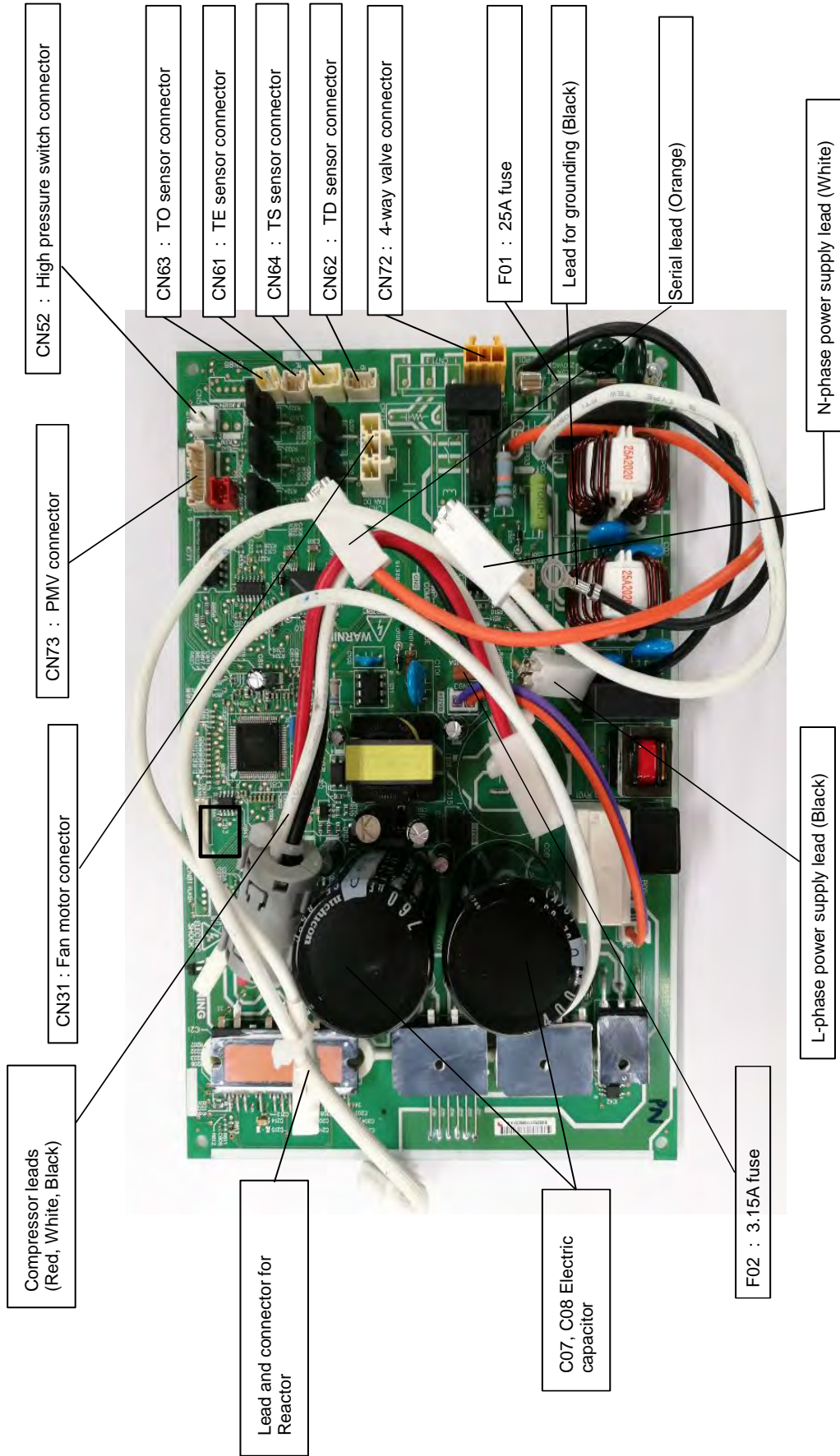

8. TROUBLESHOOTING

8-1. Summary of Troubleshooting

<Wired remote controller type>

1. Before troubleshooting

- 1) Required tools/instruments
 - ⊕ and ⊖ screwdrivers, spanners, radio cutting pliers, nippers, push pins for reset switch
 - Tester, thermometer, pressure gauge, etc.
- 2) Confirmation the following points before check
 - a) The following operations are normal.
 1. Compressor does not operate.
 - When 3-minutes delay (3 minutes after compressor OFF)
 - When the outdoor unit is in standby mode due to the room temperature reached the setup temperature
 - When the timer is operating
 - When indoor fan only operation mode
 - When an overflow error is detected in the indoor unit
 - When outside high-temperature operation controlled is in heating operation
 2. Indoor fan does not rotate.
 - When cool air discharge prevention control is working in heating operation
 3. Outdoor fan does not rotate or air volume changes.
 - When high-temperature release operation control is working in heating operation
 - When outside low-temperature operation control is working in cooling operation
 - When defrost operation is being performed
 4. ON/OFF operation cannot be performed from remote controller.
 - When the control operation is being performed from outside/remote side
 - When automatic address is being set up
 - When the test run is being performed by operation of the outdoor controller
- 3) Did you return the cabling to the initial positions?
- 4) Are indoor unit and remote controller connected correctly?

2. Troubleshooting procedure

When a trouble occurred, check the parts along with the following procedure.



NOTE

Microcomputer misdiagnosis may also be caused by power condition problem and outer noise other than the checked items. If there is any noise source, change the cables of the remote controller to shield cables.

<Wireless remote controller type>

1. Before troubleshooting

- 1) Required tools/instruments
 - ⊕ and ⊖ screwdrivers, spanners, radio cutting pliers, nippers, etc.
 - Tester, thermometer, pressure gauge, etc.
- 2) Confirmation the following points before check
 - a) The following operations are normal.
 1. Compressor does not operate.
 - When 3-minutes delay (3 minutes after compressor OFF)
 - When the outdoor unit in standby status due to the room temperature reached the setup temperature
 - When the timer is operating
 - When indoor fan only operation mode
 - When an overflow error is detected on the indoor unit
 - When outside high-temperature operation controlled is in heating operation
 2. Indoor fan does not rotate.
 - Does not cool air discharge preventive control work in heating operation?
 3. Outdoor fan does not rotate or air volume changes.
 - When high-temperature release operation control is working in heating operation
 - When outside low-temperature operation control is working in cooling operation
 - When defrost operation is being performed
 4. ON/OFF operation cannot be performed from remote controller.
 - When forced operation is being performed
 - When the control operation is being performed from outside/remote side
 - When automatic address being set up
 - When the test run is being performed by operation of the outdoor controller
 - a) Did you return the cabling to the initial positions?
 - b) Are connecting cables between indoor unit and receiving unit correct?

2. Troubleshooting procedure

(When the power is turned on at the first time or when indoor unit address setting is changed, the operation will be performed after power-ON in 5 minutes or before.)

When a trouble occurred, check the parts along with the following procedure.



1) Outline of judgment

The primary judgment to check where a trouble occurred in indoor unit or outdoor unit is performed with the following method.

The errors can be identified by lamp indication of indoor unit (sensors of the receiving unit)

The indoor unit monitors operating status of the air conditioner, and the blocked contents of self-diagnosis are displayed restricted to the following cases if a protective circuit works.

8-2. Troubleshooting

8-2-1. Outline of judgment



The following method can be done to check whether the problem occurred in indoor or outdoor unit.

The error is indicated by indication lamp on the display of the indoor unit. (sensors of the receiving part)

The indoor unit monitors the operating status of the air conditioner, and the blocked contents of self-diagnosis are displayed restricted to the following cases if a protective circuit works.

● : OFF, ○ : ON, ☼ : Flash (0.5 sec.)

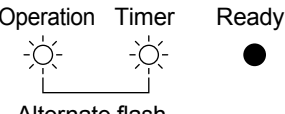
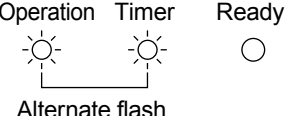
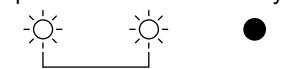
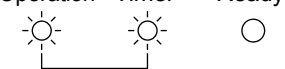
Lamp indication	Check code	Cause of trouble	
Operation Timer Ready ● ● ● No indication at all	—	Power supply OFF or miswiring between receiving unit and indoor unit	
Operation Timer Ready ☼ ● ● Flash	E01	Receiving error } Receiving unit } Sending error } Communication stop } Miswiring or wire connection error between receiving unit and indoor unit	
	E02		
	E03		
	Operation Timer Ready ☼ ● ● Flash	E08	Duplicated indoor unit No. } Duplicated header units of remote controller } Setup error
		E09	
		E10	Communication error between CPUs on indoor unit P.C. board
		E11	Communication error between Application control kit and indoor unit P.C. board
E18	Wire connection error between indoor units, Indoor power OFF (Communication stop between indoor master and follower or between main and sub indoor twin)		
Operation Timer Ready ● ● ☼ Flash	E04	Miswiring between indoor unit and outdoor unit or connection error (Communication stop between indoor and outdoor units)	
Operation Timer Ready ● ☼ ☼ Alternate flash	P10	Overflow was detected. } Indoor DC fan error } Protective device of indoor unit worked.	
	P12		
Operation Timer Ready ☼ ● ☼ Alternate flash	P03	Outdoor unit discharge temp. sensor error } High pressure protective operation, High pressure SW system } error, Power supply error, } Power supply error } Heat sink overheat error } Gas leak detection } Protective device of } outdoor unit } worked.	
	P04		
	P05		
	P07		
	P15		
	P19	4-way valve inverse error (Indoor or outdoor unit detected)	
	Operation Timer Ready ☼ ● ☼ Alternate flash	P20	High pressure protective operation } Outdoor unit fan system error } Short-circuit of compressor drive element } Position detection circuit error } Protective device of outdoor unit } worked.
		P22	
		P26	
		P29	
P31	Stopped because of error of other indoor units in a group (Check codes of E03/L03/L07/L08)		

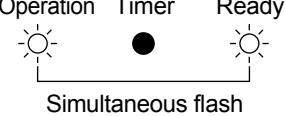
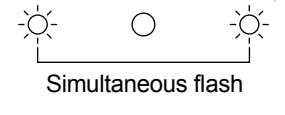
Lamp indication	Check code	Cause of trouble occurrence
Operation Timer Ready  Alternate flash	F01	Heat exchanger sensor (TCJ) error } Indoor unit sensor error Heat exchanger sensor (TC) error } Heat exchanger sensor (TA) error }
	F02	
	F10	
Operation Timer Ready  Alternate flash	F04	Discharge temp. sensor (TD) error Temp. } sensor (TE, TS) error } Sensor error of outdoor unit Outside air temp. sensor (TO) error } Suction temp. sensor (TS) error } Heat sink temp. sensor (TH) error } Miss-mounting of temp. sensor (TE, TS) }
	F06	
	F08	
	F12	
	F13	
	F15	
Operation Timer Ready  Simultaneous flash	F29	Indoor EEPROM error
Operation Timer Ready  Simultaneous flash	F31	Outdoor EEPROM error
Operation Timer Ready  Flash	H01	Compressor break down } Outdoor compressor system error Compressor lock }
	H02	
	H03	Outdoor unit current detection circuit error
	H04	Case thermostat operation
Operation Timer Ready  Simultaneous flash	L03	Duplicated header indoor units } There is indoor unit of group connection } → AUTO address in individual indoor unit. } * If group construction and Unsetting of group address } address are not normal Missed setting } power supply turned on, (Unset indoor capacity) } automatically goes to address setup mode.
	L07	
	L08	
	L09	
Operation Timer Ready  Simultaneous flash	L10	Outdoor unit unset model type of service P.C. board
	L20	Duplicated indoor central addresses
	L29	Outdoor P.C. board part error was detected (EEPROM error, Heat sink temp. sensor (TH) error) Outdoor unit unset model type of service P.C. board. Outdoor Heat sink overheat error, Gas leak detection, or 4-way valve system error.
	L30	Outside interlock error

8-2-2. Others (Other than Check Code)

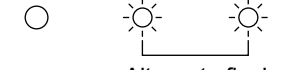
Lamp indication	Check code	Cause of trouble occurrence
Operation Timer Ready  Simultaneous flash	—	During test run
Operation Timer Ready  Alternate flash	—	Disagreement of cool/heat (Automatic cool/heat setting to automatic cool/heat prohibited model, or setting of heating to cooling-only model)

8-2-3. Monitor Function of Remote Controller Switch

■ Calling of sensor temperature display

<Contents>

Each data of the remote controller, indoor unit and outdoor unit can be shown by calling the service monitor mode from the remote controller.

<Procedure>

- 1 Push **TEST** + **CL** buttons simultaneously for 4 seconds to call the service monitor mode.

The service monitor shows up, the master indoor unit No. is displayed at first and then the temperature CODE No. **00** is displayed.



- 2 Push temperature set **TEMP** buttons and then change the CODE No. of data to be monitored.

The CODE No. list is shown below.

<RBC-AMT32E>

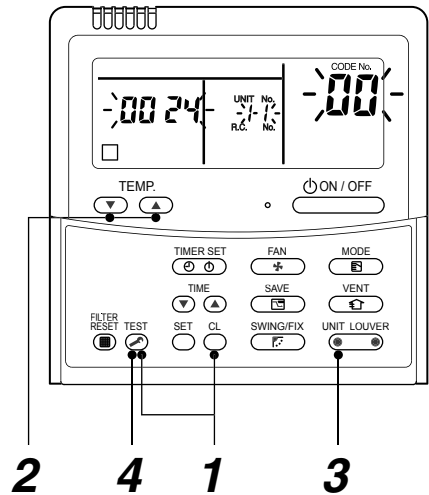

<Operation procedure>

1 → 2 → 3 → 4

Returned to usual display

	CODE No.	Data name	Unit
Indoor unit data	01	Room temperature (Remote controller)	°C
	02	Indoor suction temperature (TA)	°C
	03	Indoor heat exchanger (Coil) temperature (TCJ)	°C
	04	Indoor heat exchanger (Coil) temperature (TC)	°C
	* 07	Indoor fan revolution frequency	rpm
	* F2	Indoor fan calculated operation time	×100h
	F3	Filter sign time	×1h
	* F8	Indoor discharge temperature*1 (4-way only)	°C

	CODE No.	Data name	Unit
Outdoor unit data	60	Outdoor heat exchanger (Coil) temperature (TE)	°C
	61	Outside temperature (TO)	°C
	62	Compressor discharge temperature (TD)	°C
	63	Compressor suction temperature (TS)	°C
	6A	Operation current (× 1/10)	A
	F1	Compressor calculated operation time	×100h

- The indoor discharge temperature of CODE No. [F8] is the estimated value from TC or TCJ sensor.
Use this value to check discharge temperature at test run.
(A discharge temperature sensor is not provided to this model.)
- The data value of each item is not the real time, but value delayed by a few seconds to ten-odd seconds.



- 3 Push **UNIT LOUVER** button to select the indoor unit to be monitored.
Each data of the indoor unit and its outdoor units can be monitored.



- 4 Pushing **TEST** button to returns to the usual display.

8-2-4. Check Code List (Outdoor)

ALT (Alternate): Alternate flashing when there are two flashing LED/SIM (Simultaneous): Simultaneous flashing when there are two flashing LED

○ : ON, ⊙ : Flash, ● : OFF

Central Control indication	Remote Controller indication	Sensor lamp part		Defected position	Detection	Explanation of error contents	Automatic Reset	Operation continuation
		Block indication	Flash					
19	F04	⊙ ⊙ ○	ALT	Outdoor unit Discharge temp. sensor (TD) error	Outdoor	Disconnection, short of discharge temp. sensor (TD) was detected	X	X
18	F06	⊙ ⊙ ○	ALT	Outdoor unit heat exchanger temp. sensor (TE) error	Outdoor	Disconnection, short of outdoor unit heat exchanger temp. sensor (TE) was detected.	X	X
1b	F08	⊙ ⊙ ○	ALT	Outdoor unit Outside air temp. sensor (TO) error	Outdoor	Disconnection, short of outside air temp. Sensor (TO) was detected.	○	○
A2	F12	⊙ ⊙ ○	ALT	Outdoor unit Suction temp. sensor (TS) error	Outdoor	Disconnection, short of suction temp. Sensor (TS) was detected.	X	X
43	F13	⊙ ⊙ ○	ALT	Outdoor unit Heat sink temp. sensor (TH) error	Outdoor	Disconnection, short of heat sink temp. Sensor (TH) (P.C. board installed) was detected.	X	X
18	F15	⊙ ⊙ ○	ALT	Outdoor unit Miss-mounting of temp. sensor (TE, TS)	Outdoor	Miss-mounting of outdoor heat exchanger temp. sensor (TE) and suction temp. sensor(TS) was detected.	X	X
1F	H01	● ⊙ ●		Outdoor unit Compressor break down	Outdoor	Reached release point at min-Hz during compressor operating. Short-circuited current (lrc) was detected after DC excitation.	X	X
1d	H02	● ⊙ ●		Outdoor unit Compressor lock	Outdoor	Compressor lock was detected.	X	X
17	H03	● ⊙ ●		Outdoor unit Current detection circuit error	Outdoor	Current detection circuit error.	X	X
88	L10	⊙ ○ ⊙	SIM	Outdoor unit Unset model type of service P.C. board	Outdoor	When outdoor service P.C. board was used, model type select jumper setting was inappropriate.	X	X
1C	L29	⊙ ○ ⊙	SIM	Outdoor unit error	Outdoor	1) Outdoor P.C. board part error was detected (EEPROM error, Heat sink temp. sensor (TH) error) 2) Outdoor unit Unset model type of service P.C. board. 3) Outdoor Heat sink overheat error, Gas leak detection, or 4-way valve system error.	X	X
1E	P03	⊙ ● ⊙	ALT	Outdoor unit Discharge temp. error	Outdoor	Error was detected by discharge temp. release control.	X	X
21	P04	⊙ ● ⊙	ALT	Outdoor unit High pressure SW system error	Outdoor	High pressure protection switch operated.	X	X
AF	P05	⊙ ● ⊙	ALT	Power supply error	Outdoor	Power supply voltage error.	X	X
1C	P07	⊙ ● ⊙	ALT	Outdoor unit Heat sink overheat error	Outdoor	Abnormal overheat was detected by outdoor heat sink temp. sensor (TH).	X	X
AE	P15	⊙ ● ⊙	ALT	Gas leak detection	Outdoor	Abnormal overheat of discharge temp. sensor (TD) or suction temp. sensor (TS) was detected.	X	X
22	P20	⊙ ● ⊙	ALT	Outdoor High pressure protective operation	Outdoor	Error was detected by high pressure release control from indoor / outdoor heat exchanger temp. sensor.	X	X
1A	P22	⊙ ● ⊙	ALT	Outdoor unit Outdoor fan system error	Outdoor	Error (Over-current, lock, etc.) was detected on outdoor fan drive circuit.	X	X
14	P26	⊙ ● ⊙	ALT	Outdoor unit Short-circuit of compressor drive element	Outdoor	Short-circuited protective operation of compressor drive circuit element (G-Tr / IGBT) operated.	X	X
16	P29	⊙ ● ⊙	ALT	Outdoor unit Position detection circuit error	Outdoor	Position detection error of compressor motor was detected.	X	X
97	E01	⊙ ● ●		No remote controller master unit	Remote controller	Signal was not received from indoor unit.	-	-
-	E02	⊙ ● ●		Remote controller communication error	Remote controller	Main remote controller was not set. (including 2 remote controllers)	-	-
97	E03	⊙ ● ●		Regular communication error between indoor and remote controller	Indoor	No communication from remote controller and network adapter	○	X
04	E04	● ● ⊙		Indoor/Outdoor serial error	Indoor	Serial communication error between indoor and outdoor	○	X
96	E08	⊙ ● ●		Duplicated indoor addresses	Indoor	Same address as yours was detected.	○	X
99	E09	⊙ ● ●		Duplicated main remote controllers	Remote controller	In 2-remote controller control, both were set as master. (Indoor master unit stops warning and follower unit continues operation.)	X	X
CF	E10	⊙ ● ●		Communication error between CPU	Indoor	MCU communication error between main motor and micro computer	○	△

Central Control indication	Remote Controller indication	Sensor lamp part		Detected position	Detection	Explanation of error contents	Automatic Reset	Operation continuation
		Block indication	Flash					
4B	E11	○	●	Communication error between Application control kit and indoor unit	Indoor	Communication error between Application control kit and indoor unit P.C. board	○	X
97,99	E18	○	●	Regular communication error between master and follower indoor units	Indoor	Regular communication cannot be performed between master and follower indoor units. Communication between twin master (Main unit) and follower (sub unit) cannot be performed.	○	X
96	L03	○	●	Duplicated indoor master units	Indoor	There are multiple master units in a group.	X	X
99	L07	○	●	There is group cable in individual indoor unit.	Indoor	When even one group connection indoor unit exists in individual indoor unit	X	X
99	L08	○	●	Unset indoor group address	Indoor	Indoor address group was unset.	X	X
46	L09	○	●	Unset indoor capacity	Indoor	Capacity of indoor unit was unset.	X	X
66	L30	○	○	Outside error input to indoor unit (Interlock)	Indoor	Abnormal stop by CN80 outside error input	X	X
08	P19	○	●	4-way valve inverse error	Indoor Outdoor	In heating operation, error was detected by temp. down of indoor heat exchanger or temp. up of TE, TS.	○	X

◇ When this warning was detected before group construction/address check finish at power supply was turned on, the mode shifts automatically to AUTO address setup mode.

Error mode detected by indoor unit

Operation of diagnostic function				Judgment and measures
Check code	Cause of errors	Status of air conditioner	Condition	
E03	No communication from remote controller (including wireless) and communication adapter	Stop (Automatically reset)	Displayed when error is detected	1. Check cables of remote controller and communication adapters. • Remote controller LCD display OFF (Disconnection) • Central remote controller [97] check code
E04	The serial signal is not output from outdoor unit to indoor unit. • Miswiring of inter-unit wire • Defective serial sending circuit on outdoor P.C. board • Defective serial receiving circuit on indoor P.C. board	Stop (Automatically reset)	Displayed when error is detected	1. Outdoor unit does not completely operate. • Inter-unit wire check, correction of miswiring • Check outdoor P.C. board. Correct wiring of P.C. board. 2. When outdoor unit normally operates Check P.C. board (Indoor receiving / Outdoor sending).
E08	Duplicated indoor unit address	Stop	Displayed when error is detected	1. Check whether remote controller connection (Group/Individual) was changed or not after power supply turned on (Finish of group construction/Address check). * If group construction and address are not normal when the power has been turned on, the mode automatically shifts to address setup mode. (Resetting of address)
L03	Duplicated indoor master unit			
L07	There is group wire in individual indoor unit.			
L08	Unset indoor group address			
L09	Unset indoor capacity	Stop	Displayed when error is detected	1. Set indoor capacity (CODE No. (DN) = 11)
L30	Abnormal input of outside interlock	Stop	Displayed when error is detected	1. Check outside devices. 2. Check indoor P.C. board.
P10	Float switch operation • Float circuit, Disconnection, Coming-off, Float switch contact error	Stop	Displayed when error is detected	1. Trouble of drain pump 2. Clogging of drain pump 3. Check float switch. 4. Check indoor P.C. board. 5. Check Application control kit of indoor unit
P12	Indoor DC fan error	Stop	Displayed when error is detected	1. Position detection error 2. Over-current protective circuit of indoor fan driving unit operated. 3. Indoor fan locked. 4. Check indoor P.C. board.
P19	4-way valve system error • After heating operation has started, indoor heat exchangers temp. is down.	Stop (Automatically reset)	Displayed when error is detected	1. Check 4-way valve. 2. Check PMV 3. Check indoor heat exchanger (TC/TCJ). 4. Check indoor P.C. board.
P31	Own unit stops while warning is output to other indoor units.	Stop (Follower unit) (Automatically reset)	Displayed when error is detected	1. Judge follower unit while header unit is [E03], [L03], [L07] or [L08]. 2. Check indoor P.C. board.
F01	Coming-off, disconnection or short of indoor heat exchanger temp. sensor (TCJ)	Stop (Automatically reset)	Displayed when error is detected	1. Check indoor heat exchanger temp. sensor (TCJ). 2. Check indoor P.C. board.
F02	Coming-off, disconnection or short of indoor heat exchanger temp. sensor (TC)	Stop (Automatically reset)	Displayed when error is detected	1. Check indoor heat exchanger temp. sensor (TC). 2. Check indoor P.C. board.
F10	Coming-off, disconnection or short of indoor heat exchanger temp. sensor (TA)	Stop (Automatically reset)	Displayed when error is detected	1. Check indoor heat exchanger temp. sensor (TA). 2. Check indoor P.C. board.
F29	Indoor EEPROM error • EEPROM access error	Stop (Automatically reset)	Displayed when error is detected	1. Check indoor EEPROM. (including socket insertion) 2. Check indoor P.C. board.
E10	Communication error between indoor MCU • Communication error between fan driving MCU and main MCU	Stop (Automatically reset)	Displayed when error is detected	1. Check indoor P.C. board.
E11	Communication error between Application and indoor unit	Stop (Automatically reset)	Displayed when error is detected	1. Check power supply / communication harness 2. Check indoor P.C. board
E18	Regular communication error between indoor master and follower units and between main and sub units	Stop (Automatically reset)	Displayed when error is detected	1. Check remote controller wiring. 2. Check indoor power supply wiring. 3. Check indoor P.C. board.

Error mode detected by outdoor unit

Operation of diagnostic function				Judgment and measures
Check code	Cause of errors	Status of air conditioner	Condition	
Indoor unit				
F04	Disconnection, short of discharge temp. sensor (TD)	Stop	Displayed when error is detected	1. Check discharge temp. sensor (TD). 2. Check outdoor P.C. board
F06	Disconnection, short of heat exchanger temp. sensor (TE)	Stop	Displayed when error is detected	1. Check heat exchanger temp. sensor (TE). 2. Check outdoor P.C. board .
F12	Disconnection, short of suction temp. sensor (TS)	Stop	Displayed when error is detected	1. Check suction temp. sensor (TS). 2. Check outdoor P.C. board.
F15	Miss-mounting of outdoor temp. sensor (TE, TS)	Stop	Displayed when error is detected	1. Check temp. sensor (TE, TS). 2. Check outdoor P.C. board.
F08	Disconnection, short of outside air temp. sensor (TO)	Continue	Displayed when error is detected	1. Check outside air temp. sensor (TO). 2. Check outdoor P.C. board.
F13	Disconnection, short of heat sink temp. sensor (TH)	Stop	Displayed when error is detected	1. Check outdoor P.C. board
F31	Outdoor EEPROM error	Stop	Displayed when error is detected	1. Check outdoor P.C. board.
L10	Unset model type of service P.C. board	Stop	Displayed when error is detected	1. Outdoor service P.C. board. Check model type setting jumper wire.
P07	Heat sink overheat error * Heat sink temp. sensor detected over specified temperature.	Stop	Displayed when error is detected	1. Check screw tightening between P.C. board and heat sink and check radiator grease. 2. Check heat sink blast path.
P15	Detection of gas leak * Discharge temp. sensor (TD), Suction temp. sensor (TS) detected temperature over specified temp.	Stop	Displayed when error is detected	1. Check gas leak, recharge 2. Check full open of service valve. 3. Check PMV (Pulse Motor Valve). 4. Check broken pipe. 5. Check discharge temp. sensor (TD), suction temp. sensor (TS).
P19	4-way valve inverse error * After heating operation has started, indoor heat exchanger temp. drops under the specified temp. * After heating operation has started, outdoor heat exchanger / suction temp. rises over the specified temp.	Stop	Displayed when error is detected	1. Check operation of 4-way valve. 2. Check outdoor heat exchanger (TE), suction temp. sensor (TS). 3. Check indoor heat exchanger sensor (TC). 4. Check 4-way valve coil. 5. Check PMV (Pulse Motor Valve).
H01	Compressor break down * Although operation has started, operation frequency decreases and operation stops.	Stop	Displayed when error is detected	1. Check power supply voltage. (50 Hz : AC 198 to 264 V, 60 Hz : AC 198 to 242 V) 2. Overload operation of refrigerating cycle
H02	Compressor lock * Over-current detection after compressor start-up	Stop	Displayed when error is detected	1. Compressor problem (Lock, etc.): Replace compressor. 2. Compressor wiring error (Open phase)

Operation of diagnostic function				Judgment and measures
Check code	Cause of errors	Status of air conditioner	Condition	
Indoor unit				
H03	Current detection circuit error	Stop	Displayed when error is detected	1. Check outdoor P.C. board. (AC current detection circuit)
P03	Discharge temp. error * Discharge temp. (TD) over specified value was detected.	Stop	Displayed when error is detected	1. Check refrigerating cycle (Gas leak) 2. Check PMV (Pulse Motor Valve) 3. Check discharge temp. sensor (TD).
P04	High pressure SW system error	Stop	Displayed when error is detected	1. Check service valves are fully opened. (Gas side, Liquid side) 2. Check outdoor fan operation. 3. Check motor error of outdoor fan. 4. Check clogging of outdoor PMV. 5. Check clogging of heat exchanger in indoor/outdoor units. 6. Short-circuit of suction/discharge air in outdoor unit. 7. Check outdoor P.C. board error. 8. Check fan system error (Cause of air volume drop) at indoor side. 9. Check PMV opening status in indoor unit.
P05	Power supply voltage error	Stop	Displayed when error is detected	1. Check power supply voltage. 50 Hz : AC 198 to 264 V, 60 Hz : AC 198 to 242 V
P20	High pressure protective operation • During cooling operation, outdoor temp. sensor (TE) detected temperature over specified temp. • During heating operation, indoor temp. sensor (TC, TCJ) detected temperature over specified temp.	Stop	Displayed when error is detected	1. Check outdoor heat exchanger sensor (TE). 2. Check indoor heat exchanger sensor (TC, TCJ). 3. Check full open of service valve. 4. Check indoor/outdoor fan. 5. Check PMV (Pulse Motor Valve). 6. Check clogging and short circuit of indoor/outdoor heat exchanger. 7. Overcharge of refrigerant. Recharge
P22	Outdoor fan system error	Stop	Displayed when error is detected	1. Check lock of fan motor. 2. Check power supply voltage. 50 Hz : AC 198 to 264 V, 60 Hz : AC 198 to 242 V 3. Check outdoor P.C. board.
P26	Short-circuit error of compressor driving element	Stop	Displayed when error is detected	1. When performing operation while taking-off compressor wire. If P26 error occurs, check control P.C. board. 2. When performing operation while taking-off compressor wire. If an error does not occurs, compressor is layer short.
P29	Position detection circuit error	Stop	Displayed when error is detected	1. Check control P.C. board.

Error mode detected by remote controller or central controller (TCC-LINK)

Operation of diagnostic function				Judgment and measures
Check code	Cause of errors	Status of air conditioner	Condition	
Not displayed at all (Operation on remote controller cannot be operated.)	No communication with master indoor unit <ul style="list-style-type: none"> • Remote controller wiring is not correct. • Power of indoor unit is not turned on. • Automatic address cannot be completed. 	Stop	—	Power supply error of remote controller, Indoor EEPROM error <ol style="list-style-type: none"> 1. Check remote controller inter-unit wiring. 2. Check remote controller. 3. Check indoor power wiring. 4. Check indoor P.C. board. 5. Check indoor EEPROM. (including socket insertion) → Automatic address repeating phenomenon generates.
E01 *1	No communication with master indoor unit <ul style="list-style-type: none"> • Disconnection of inter-unit wire between remote controller and master indoor unit (Detected by remote controller side) 	Stop (Automatically reset) * If center exists, operation continues.	Displayed when error is detected	Receiving error from remote controller <ol style="list-style-type: none"> 1. Check remote controller inter-unit wiring. 2. Check remote controller. 3. Check indoor power wiring. 4. Check indoor P.C. board.
E02	Signal send error to indoor unit (Detected by remote controller side)	Stop (Automatically reset) * If center exists, operation continues.	Displayed when error is detected	Error sending of remote controller <ol style="list-style-type: none"> 1. Check sending circuit inside the remote controller. → Replace remote controller.
E09	There are multiple main remote controllers. (Detected by remote controller side)	Stop (Sub unit continues operation.)	Displayed when error is detected	<ol style="list-style-type: none"> 1. In 2-remote controllers (including wireless), there are multiple main units. Check that there are 1 main remote controller and other sub remote controllers.
L20 ----- Central controller L20	Duplicated indoor central addresses on communication of central control system (Detected by indoor/central controller side)	Stop (Automatically reset)	Displayed when error is detected	<ol style="list-style-type: none"> 1. Check setting of central control system network address. (Network adapter SW01) 2. Check network adapter P.C. board.
— *2 ----- Central controller (Send) C05 (Receive) C06	Communication circuit error of central control system (Detected by central controller side)	Continues (By remote controller)	Displayed when error is detected	<ol style="list-style-type: none"> 1. Check communication wire / miswiring 2. Check communication (U3, U4 terminals) 3. Check network adapter P.C. board. 4. Check central controller (such as central control remote controller, etc.) 5. Check terminal resistance. (TCC-LINK)
----- Central controller P30	Indoor Gr sub unit error (Detected by central controller side)	Continuation/Stop (According to each case)	Displayed when error is detected	Check the check code of the corresponding unit from remote controller.

*1 The check code cannot be displayed by the wired remote controller.
(Usual operation of air conditioner becomes unavailable.)

For the wireless models, an error is notified by indication lamp.

*2 This trouble is related to communication of remote controller (A, B), central system (TCC-LINK U3, U4), and [E01], [E02], [E03], [E09] or [E18] is displayed or no check display on the remote controller according to the contents.

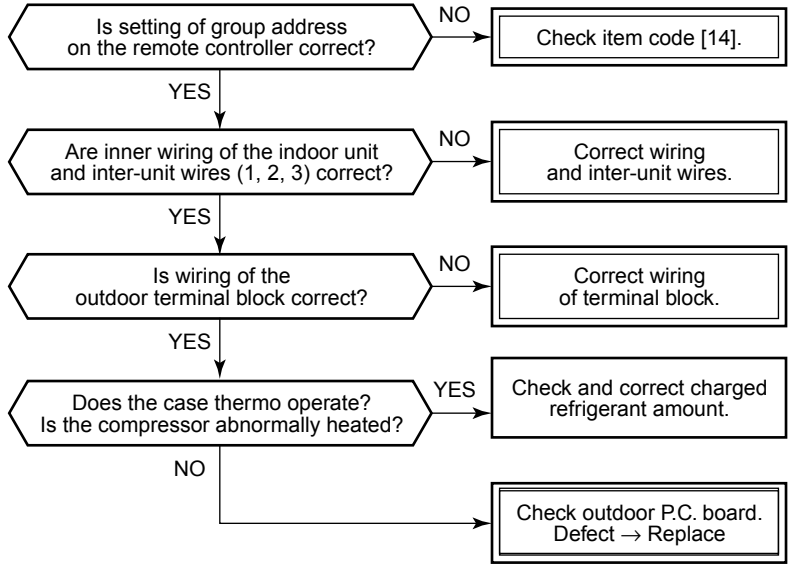
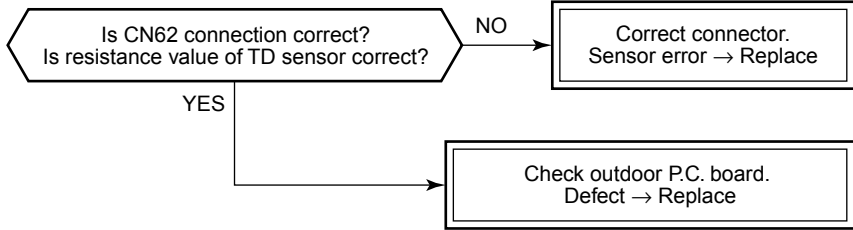
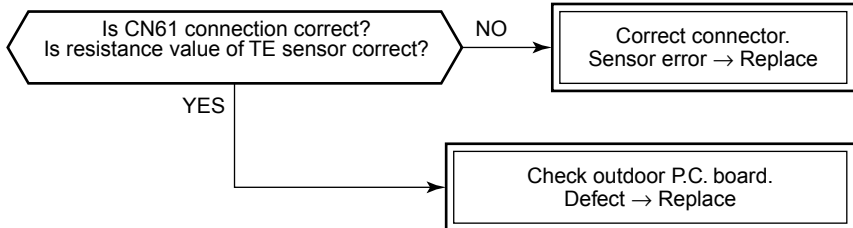
Check code	Outdoor LED display	Check and troubleshooting (Item without special mention indicates part of outdoor unit.)
[E04]	—	<p>[Indoor / Outdoor communication error]</p>  <pre> graph TD Q1{{Is setting of group address on the remote controller correct?}} -- NO --> A1[Check item code [14].] Q1 -- YES --> Q2{{Are inner wiring of the indoor unit and inter-unit wires (1, 2, 3) correct?}} Q2 -- NO --> A2[Correct wiring and inter-unit wires.] Q2 -- YES --> Q3{{Is wiring of the outdoor terminal block correct?}} Q3 -- NO --> A3[Correct wiring of terminal block.] Q3 -- YES --> Q4{{Does the case thermo operate? Is the compressor abnormally heated?}} Q4 -- YES --> A4[Check and correct charged refrigerant amount.] Q4 -- NO --> A5[Check outdoor P.C. board. Defect -> Replace] </pre>
[F04]	—	<p>[Discharge temp. sensor (TD) error]</p>  <pre> graph TD Q1{{Is CN62 connection correct? Is resistance value of TD sensor correct?}} -- NO --> A1[Correct connector. Sensor error -> Replace] Q1 -- YES --> A2[Check outdoor P.C. board. Defect -> Replace] </pre>
[F06]	—	<p>Heat exchanger temp. sensor (TE) error]</p>  <pre> graph TD Q1{{Is CN61 connection correct? Is resistance value of TE sensor correct?}} -- NO --> A1[Correct connector. Sensor error -> Replace] Q1 -- YES --> A2[Check outdoor P.C. board. Defect -> Replace] </pre>

Check code	Outdoor LED display	Check and troubleshooting (Item without special mention indicates part of outdoor unit.)
[F08]	—	<p>[Outside air temp. sensor (TO) error]</p> <pre> graph TD Q1{{Is CN63 connection correct? Is resistance value of TO sensor correct?}} Q1 -- NO --> A1[Correct connector. Sensor error → Replace] Q1 -- YES --> A2[Check outdoor P.C. board. Defect → Replace] </pre>
[F12]	—	<p>[Suction temp. sensor (TS) error]</p> <pre> graph TD Q1{{Is CN64 connection correct? Is resistance value of TS sensor correct?}} Q1 -- NO --> A1[Correct connector. Sensor error → Replace] Q1 -- YES --> A2[Check outdoor P.C. board. Defect → Replace] </pre>
[F13]	—	<p>[Heat sink temp. sensor (TH) error]</p> <pre> graph TD A1[Check outdoor P.C. board. Defect → Replace] </pre>
[F15]	—	<p>[Miss-mounting of outdoor temp. sensor (TE)]</p> <pre> graph TD Q1{{Is mounting status of TE and TS sensors correct?}} Q1 -- NO --> A1[Correct sensor mounting.] Q1 -- YES --> Q2{{Is CN64 connection correct? Is resistance value of TS sensor correct?}} Q2 -- NO --> A2[Correct connector. Sensor error → Replace] Q2 -- YES --> Q3{{Is CN61 connection correct? Is resistance value of TE sensor correct?}} Q3 -- NO --> A3[Correct connector. Sensor error → Replace] Q3 -- YES --> A4[Check outdoor P.C. board. Defect → Replace] </pre>

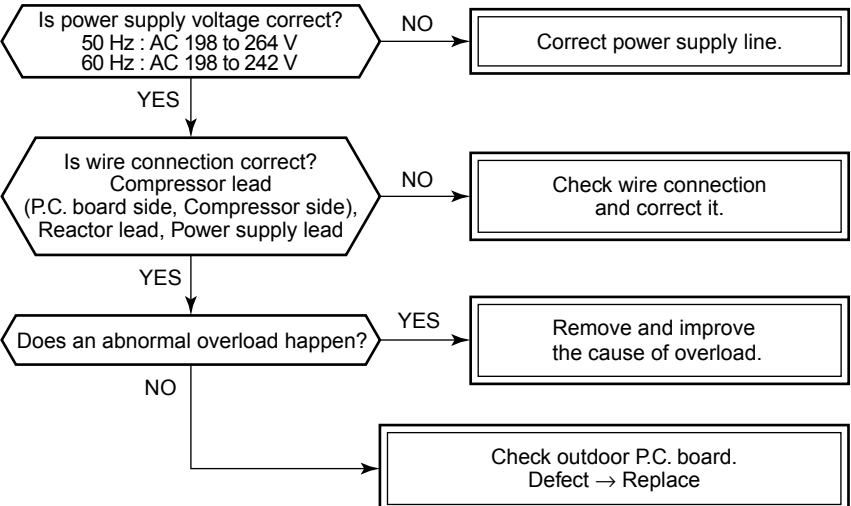
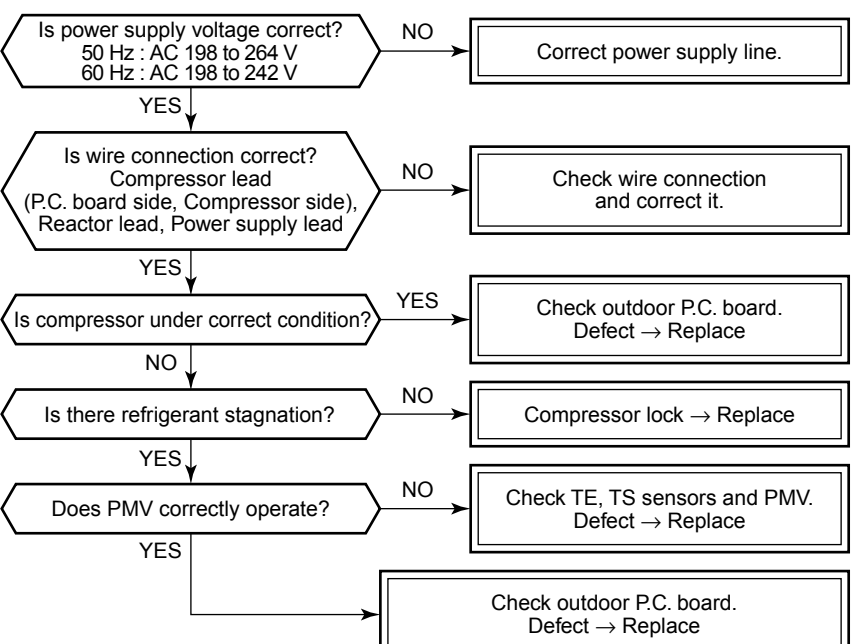
Check code	Outdoor LED display	Check and troubleshooting (Item without special mention indicates part of outdoor unit.)
[F31]	—	<p>[EEPROM error]</p> <div style="border: 1px solid black; padding: 5px; width: fit-content; margin: 10px auto;"> Check outdoor P.C. board. Defect → Replace </div>
[H01]	—	<p>[Compressor break down]</p>  <pre> graph TD Q1{{Is power supply voltage correct? 50 Hz : AC 198 to 264 V 60 Hz : AC 198 to 242 V}} A1[Correct power supply line.] Q2{{Is wire connection correct? Compressor lead (P.C. board side, Compressor side), Reactor lead, Power supply lead}} A2[Check wire connection and correct it.] Q3{{Does an abnormal overload happen?}} A3[Remove and improve the cause of overload.] A4[Check outdoor P.C. board. Defect → Replace] Q1 -- NO --> A1 Q1 -- YES --> Q2 Q2 -- NO --> A2 Q2 -- YES --> Q3 Q3 -- YES --> A3 Q3 -- NO --> A4 </pre>
[H02]	—	<p>[Compressor lock]</p>  <pre> graph TD Q1{{Is power supply voltage correct? 50 Hz : AC 198 to 264 V 60 Hz : AC 198 to 242 V}} A1[Correct power supply line.] Q2{{Is wire connection correct? Compressor lead (P.C. board side, Compressor side), Reactor lead, Power supply lead}} A2[Check wire connection and correct it.] Q3{{Is compressor under correct condition?}} A3[Check outdoor P.C. board. Defect → Replace] Q4{{Is there refrigerant stagnation?}} A4[Compressor lock → Replace] Q5{{Does PMV correctly operate?}} A5[Check TE, TS sensors and PMV. Defect → Replace] A6[Check outdoor P.C. board. Defect → Replace] Q1 -- NO --> A1 Q1 -- YES --> Q2 Q2 -- NO --> A2 Q2 -- YES --> Q3 Q3 -- YES --> A3 Q3 -- NO --> Q4 Q4 -- NO --> A4 Q4 -- YES --> Q5 Q5 -- NO --> A5 Q5 -- YES --> A6 </pre>

Check code	Outdoor LED display	Check and troubleshooting (Item without special mention indicates part of outdoor unit.)
[H03]	—	<p>[Current detection circuit error]</p> <div style="border: 1px solid black; padding: 5px; width: fit-content; margin: 0 auto;"> Check outdoor P.C. board. Defect → Replace </div>
[L10]	—	<p>[Unset model type] : Only when service P.C. board is used</p> <div style="border: 1px solid black; padding: 5px; width: fit-content; margin: 0 auto;"> Cut jumper line according to the explanation sheet packaged with the service P.C. board. </div>
[P03]	—	<p>[Discharge temp. error]</p> <pre> graph TD Q1{{Is there gas leak? Is there refrigerant shortage?}} -- YES --> A1[Repair defective position. Recharge refrigerant.] Q1 -- NO --> Q2{{Is PMV under correct condition?}} Q2 -- NO --> A2[Repair defective position. Replace defective part.] Q2 -- YES --> Q3{{Does an abnormal overload happen?}} Q3 -- YES --> A3[Remove and improve the cause of overload.] Q3 -- NO --> Q4{{Is CN601 connection correct? Is resistance value of TD sensor correct?}} Q4 -- NO --> A4[Correct connector. Sensor error → Replace] Q4 -- YES --> A5[Check outdoor P.C. board. Defect → Replace] </pre>
[P05]	—	<p>[Power supply error]</p> <pre> graph TD Q1{{Is the power supply voltage is lower than or over the range? 50 Hz : AC 198 to 264 V 60 Hz : AC 198 to 242 V}} -- YES --> A1[Confirm power supply, etc.] Q1 -- NO --> A2[Check outdoor P.C. board. Defect → Replace] </pre>
[P07]	—	<p>[Heat sink overheat error]</p> <pre> graph TD Q1{{Is the power device on P.C. board tightly screwed? Are radiation grease properly applied?}} -- NO --> A1[Apply radiation grease to the power device. Retightening of screws.] Q1 -- YES --> Q2{{Does anything block the ventilation around the heat sink? Does anything block air flow from the fan?}} Q2 -- YES --> A2[Remove blocking matter. Correct short-circuit.] Q2 -- NO --> A3[Check outdoor P.C. board. Defect → Replace] </pre>

Check code	Outdoor LED display	Check and troubleshooting (Item without special mention Indicates part of outdoor unit.)
[P15]	—	<p>[Gas leak detection]</p> <pre> graph TD Q1{{Is there gas leak? Is there refrigerant shortage?}} -- YES --> A1[Repair defective position. Recharge refrigerant.] Q1 -- NO --> Q2{{Is PMV under correct condition?}} Q2 -- YES --> Q3{{Is service valve fully opened?}} Q2 -- NO --> A2[Correct defective position. Replace defective part.] Q3 -- YES --> Q4{{Is there crushed pipe?}} Q3 -- NO --> A3[Open service valve fully.] Q4 -- YES --> A4[Correct and replace piping.] Q4 -- NO --> Q5{{Check temp. sensor. TD sensor CN601, TS sensor CN603}} Q5 -- Error --> A5[Correct connector. Sensor error -> Replace] Q5 -- OK --> A6[Check outdoor P.C. board. Defect -> Replace] </pre>
[P19]	—	<p>[4-way valve inverse error]</p> <pre> graph TD Q1{{Is operation of 4-way valve correct? (Check pipe temp. and etc. in cooling/heating operation.)}} -- YES --> Q2{{Are temperature sensors correct? TE sensor: GM30, 40 : CN61 TS sensor: GM30, 40 : CN64}} Q1 -- NO --> Q3{{Is the 4-way valve coil is normal? (Check the resistance value of 4-way valve coil)}} Q2 -- YES --> Q4{{Is refrigerant flow by PMV correct?}} Q2 -- NO --> A1[Replace TE sensor. Replace TS sensor.] Q4 -- YES --> Q5{{Are resistance value of indoor TC and TCJ sensors correct?}} Q4 -- NO --> A2[Check and replace of PMV] Q5 -- YES --> A3[Check indoor P.C. board. Defect -> Replace] Q5 -- NO --> A4[Check outdoor P.C. board. Defect -> Replace] Q3 -- YES --> Q6{{Does power supply to 4-way valve coil when 4-way valve is operated?}} Q3 -- NO --> A5[Replace coil of 4-way valve.] Q6 -- YES --> A6[Check outdoor P.C. board. Defect -> Replace] Q6 -- NO --> Q7{{Check outdoor P.C. board.}} Q7 -- Error --> A7[Check outdoor P.C. board. Defect -> Replace] Q7 -- OK --> A8[Check 4-way valve. Defect -> Replace] </pre>

Check code	Outdoor LED display	Check and troubleshooting (Item without special mention indicates part of outdoor unit.)
[P20]	—	<p>[High pressure protective operation]</p> <pre> graph TD Start([Is service valve fully opened?]) -- NO --> Action1[Open service valve fully.] Start -- VBP --> Action2[Reset the power supply and then make a test run matching to the season.] Action2 --> Split(()) Split --> CoolingSeason[Cooling season Cooling operation] Split --> HeatingSeason[Heating season Heating operation] CoolingSeason --> Q1{Is resistance value of outdoor TE sensor correct?} Q1 -- NO --> Action3[Replace sensor.] Q1 -- VBP --> Q2{Is there any defect such as loosen nut in outdoor fan?} Q2 -- VBP --> Action4[Check outdoor fan. Defect -> Replace, retightening] Q2 -- NO --> Q3{Does the outdoor fan perform abnormal operation?} Q3 -- VBP --> Action5[Check the same items as [P22] error.] Q3 -- NO --> Q4{Is there any element which blocks heat exchanger of outdoor unit? • Clogging of heat exchanger • Short circuit} Q4 -- VBP --> Action6[Eliminate interfering element.] Q4 -- NO --> Action7[Check overcharge of refrigerant, clogging of cycle, broken pipe, abnormal overload, etc. Defect -> Correct defective position.] HeatingSeason --> Q5{Does indoor fan correctly operate?} Q5 -- VBP --> Q6{Is there any element blocks heat exchanger of indoor unit? • Clogging of filter • Clogging of heat exchanger • Short circuit} Q6 -- VBP --> Action8[Eliminate interfering element.] Q6 -- NO --> Action9[Check overcharge of refrigerant, clogging of cycle, broken pipe, abnormal overload, etc. Defect -> Correct defective position.] Q5 -- NO --> Q7{Are indoor fan motor and connector correct?} Q7 -- NO --> Action10[Correct the connection.] Q7 -- VBP --> Q8{Are resistance values of indoor TC and TCJ sensors correct?} Q8 -- NO --> Action11[Replace sensor.] Q8 -- VBP --> Action12[Check indoor P.C. board. Defect -> Replace] </pre>

Check code	Outdoor LED display	Check and troubleshooting (Item without special mention indicates part of outdoor unit.)
[P22]	—	<p>[Fan system error]</p> <pre> graph TD Q1{{Is the power supply voltage is lower than or over the range? 50 Hz : AC 198 to 264 V 60 Hz : AC 198 to 242 V}} A1[Check wiring construction. Ask to repair the power supply.] Q2{{Rotate shaft of the fan motor by hands during power-OFF. Can it be rotated smoothly? Is the resistance value of fan motor coil correct? Between red and white lead wire : 12 to 35Ω Between white and black lead wire : 12 to 35Ω Between black and red lead wire : 12 to 35Ω}} A2[Replace fan motor.] A3[Check outdoor P.C. board. Defect → Replace] Q1 -- NO --> A1 Q1 -- YES --> Q2 Q2 -- YES --> A3 Q2 -- NO --> A2 </pre>
[P26]	—	<p>[Short-circuit of compressor driving elements]</p> <pre> graph TD Q1{{Are connections of compressor lead and reactor lead correct? (Check referring to Wiring diagram.)}} A1[Correct wiring.] Q2{{Does the same error occur in operation without compressor lead?}} A2[Replace outdoor P.C. board.] A3[Check compressor. (Layer short, etc.) Defect → Replace] Q1 -- NO --> A1 Q1 -- YES --> Q2 Q2 -- YES --> A2 Q2 -- NO --> A3 </pre>
[P29]	—	<p>[Position detection circuit error]</p> <p>Check outdoor P.C. board. Defect → Replace</p>
— No code	—	<p>[Other] Compressor disorder due to sudden change of load, etc. * Although the display of outdoor LED outputs, the unit automatically restarts and error is not determined. * A code may appear when an open phase of compressor, coming-out of wires or power relay trouble occurred.</p>

8-2-5. Diagnostic Procedure for Each Check Code (Outdoor Unit)

Temperature sensor Temperature – Resistance value characteristic table

TA, TC, TCJ, TE, TS, TO sensors

TD sensors

Representative value

Representative value

Temperature (°C)	Resistance value (kΩ)		
	(Minimum value)	(Standard value)	(Maximum value)
0	32.33	33.80	35.30
10	19.63	20.35	21.09
20	12.23	12.59	12.95
25	9.75	10.00	10.25
30	7.764	7.990	8.218
40	5.013	5.192	5.375
50	3.312	3.451	3.594
60	2.236	2.343	2.454
70	1.540	1.623	1.709
80	1.082	1.146	1.213
90	0.7740	0.8237	0.8761
100	0.5634	0.6023	0.6434

Temperature (°C)	Resistance value (kΩ)		
	(Minimum value)	(Standard value)	(Maximum value)
0	150.5	161.3	172.7
10	92.76	99.05	105.6
20	58.61	62.36	66.26
25	47.01	49.93	52.97
30	37.93	40.22	42.59
40	25.12	26.55	28.03
50	17.00	17.92	18.86
60	11.74	12.34	12.95
70	8.269	8.668	9.074
80	5.925	6.195	6.470
90	4.321	4.507	4.696
100	3.205	3.336	3.468

TA, TC, TCJ, TE, TS, TO sensors

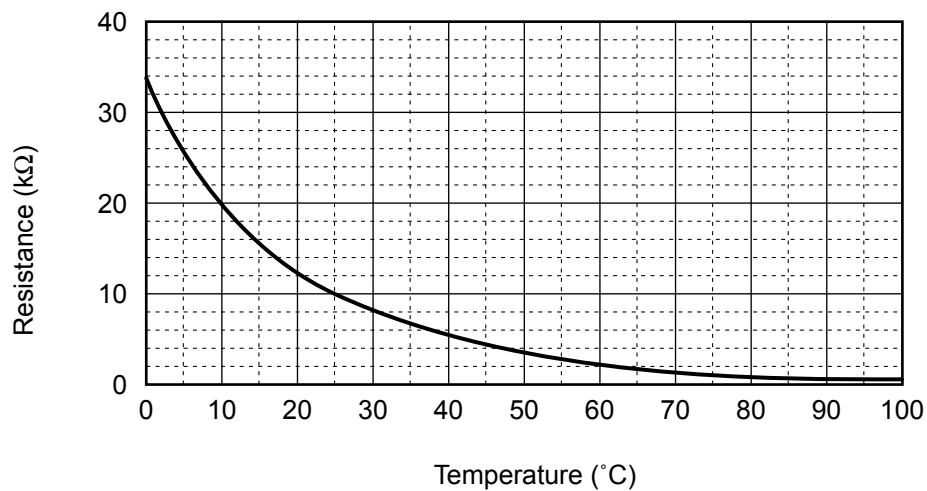

TD sensors

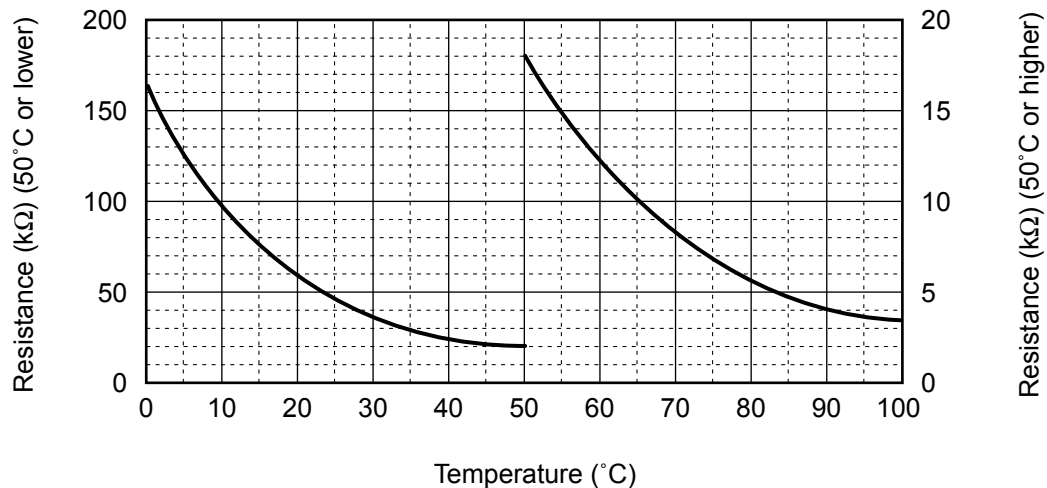

* As TH sensor (Outdoor unit heat sink temp. sensor) is incorporated in the outdoor control P.C. board, the resistance value cannot be measured.

8-3. Table Inspection of outdoor unit main parts

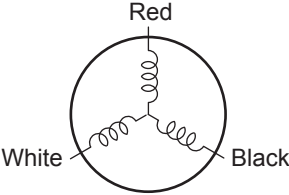
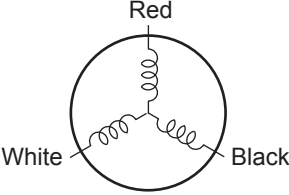
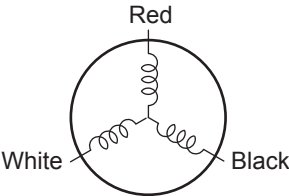
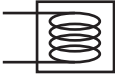
No.	Parts name	Checking procedure						
1	Compressor (Model : KSK89D53UFZ)	<p>Measure the resistance value of each winding by using the tester.</p> <div style="display: flex; align-items: center; justify-content: center;">  <table border="1" style="margin-left: 20px;"> <thead> <tr> <th data-bbox="967 335 1206 388">Position</th> <th data-bbox="1206 335 1446 388">Resistance value</th> </tr> </thead> <tbody> <tr> <td data-bbox="967 388 1206 440">Red – White</td> <td data-bbox="1206 388 1446 564" rowspan="3" style="text-align: center; vertical-align: middle;">2.35±7% Ω</td> </tr> <tr> <td data-bbox="967 440 1206 493">White – Black</td> </tr> <tr> <td data-bbox="967 493 1206 564">Black – Red</td> </tr> </tbody> </table> </div> <p style="text-align: right;">at 20°C</p>	Position	Resistance value	Red – White	2.35±7% Ω	White – Black	Black – Red
Position	Resistance value							
Red – White	2.35±7% Ω							
White – Black								
Black – Red								
2	Compressor (Model : KTN130D30UFZ)	<p>Measure the resistance value of each winding by using the tester.</p> <div style="display: flex; align-items: center; justify-content: center;">  <table border="1" style="margin-left: 20px;"> <thead> <tr> <th data-bbox="967 707 1206 759">Position</th> <th data-bbox="1206 707 1446 759">Resistance value</th> </tr> </thead> <tbody> <tr> <td data-bbox="967 759 1206 812">Red – White</td> <td data-bbox="1206 759 1446 936" rowspan="3" style="text-align: center; vertical-align: middle;">1.02±7% Ω</td> </tr> <tr> <td data-bbox="967 812 1206 865">White – Black</td> </tr> <tr> <td data-bbox="967 865 1206 936">Black – Red</td> </tr> </tbody> </table> </div> <p style="text-align: right;">at 20°C</p>	Position	Resistance value	Red – White	1.02±7% Ω	White – Black	Black – Red
Position	Resistance value							
Red – White	1.02±7% Ω							
White – Black								
Black – Red								
3	Fan motor (Model :WDF-340-A43-1)	<p>Measure the resistance value of each winding by using the tester.</p> <div style="display: flex; align-items: center; justify-content: center;">  <table border="1" style="margin-left: 20px;"> <thead> <tr> <th data-bbox="967 1074 1206 1127">Position</th> <th data-bbox="1206 1074 1446 1127">Resistance value</th> </tr> </thead> <tbody> <tr> <td data-bbox="967 1127 1206 1180">Red – White</td> <td data-bbox="1206 1127 1446 1304" rowspan="3" style="text-align: center; vertical-align: middle;">33.7±1.7 Ω</td> </tr> <tr> <td data-bbox="967 1180 1206 1232">White – Black</td> </tr> <tr> <td data-bbox="967 1232 1206 1304">Black – Red</td> </tr> </tbody> </table> </div> <p style="text-align: right;">at 20°C</p>	Position	Resistance value	Red – White	33.7±1.7 Ω	White – Black	Black – Red
Position	Resistance value							
Red – White	33.7±1.7 Ω							
White – Black								
Black – Red								
4	4-way valve coil (Cooling/heating switching) (Model :SQA2522G-000352)	<p>Measure the resistance value of each winding by using the tester.</p> <div style="display: flex; align-items: center; justify-content: center;">  <table border="1" style="margin-left: 20px;"> <thead> <tr> <th data-bbox="967 1448 1446 1501">Resistance value</th> </tr> </thead> <tbody> <tr> <td data-bbox="967 1501 1446 1563" style="text-align: center;">2210±221 Ω</td> </tr> </tbody> </table> </div> <p style="text-align: right;">at 20°C</p>	Resistance value	2210±221 Ω				
Resistance value								
2210±221 Ω								

9. SETUP AT LOCAL SITE AND OTHERS

9-1. Calling of Error History

<Contents>

The error contents in the past can be called.

<Procedure>

- 1** Push **SET** + **TEST** buttons simultaneously for **4 seconds or more to call the service check mode.**
Service Check goes on, the **CODE No.** $\square\square$ is displayed, and then the content of the latest alarm is displayed. The number and error contents of the indoor unit in which an error occurred are displayed.
- 2** In order to monitor another error history, push the set temperature ∇ / \blacktriangle buttons to change the error history No. (CODE No.).
CODE No. $\square\square$ (Latest) \rightarrow **CODE No.** $\square\square$ (Old)
NOTE : 4 error histories are stored in memory.
- 3** Pushing **TEST** button returns the display to usual display.

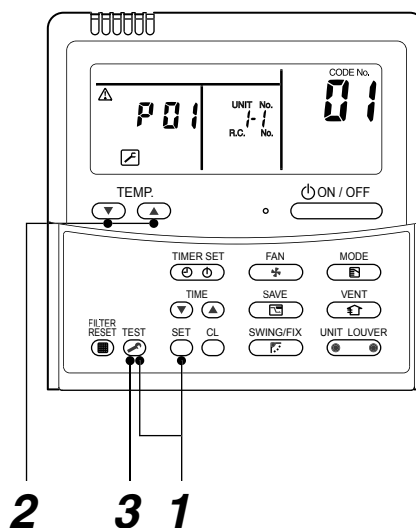

<Operation procedure>

1 \rightarrow **2** \rightarrow **3**

↑
Returned to usual display

REQUIREMENT

Do not push **CL** button, otherwise all the error histories of the indoor unit are deleted.

9-2. Group Control Operation

In a group control, operation of maximum 8 indoor units can be controlled by a remote controller. The indoor unit connected with outdoor unit (Individual) controls room temperature according to setting on the remote controller.

<System example>

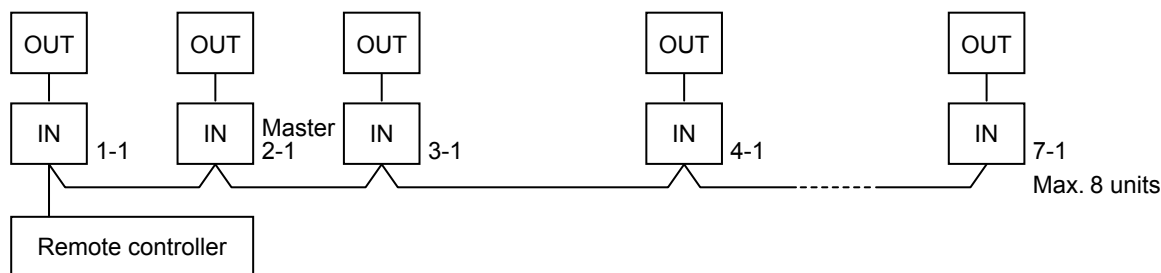

1. Display range on remote controller
The setup range (Operation mode/Air volume select/Setup temp) of the indoor unit which was set to the master unit is reflected on the remote controller.
2. Address setup
Turn on power of the indoor unit to be controlled in a group within 3 minutes after setting of automatic address. If power of the indoor unit is not turned on within 3 minutes (completion of automatic address setting), the system is rebooted and the automatic address setting will be judged again.
 - 1) Connect 3 In/Out cables surely.
 - 2) Check line address/indoor address/group address of the unit one by one.
 - 3) The unit No. (line/indoor gout address) which have been set once keep the present status as a rule if the unit No. is not duplicated with one of another unit.

■ Indoor unit power-ON sequence

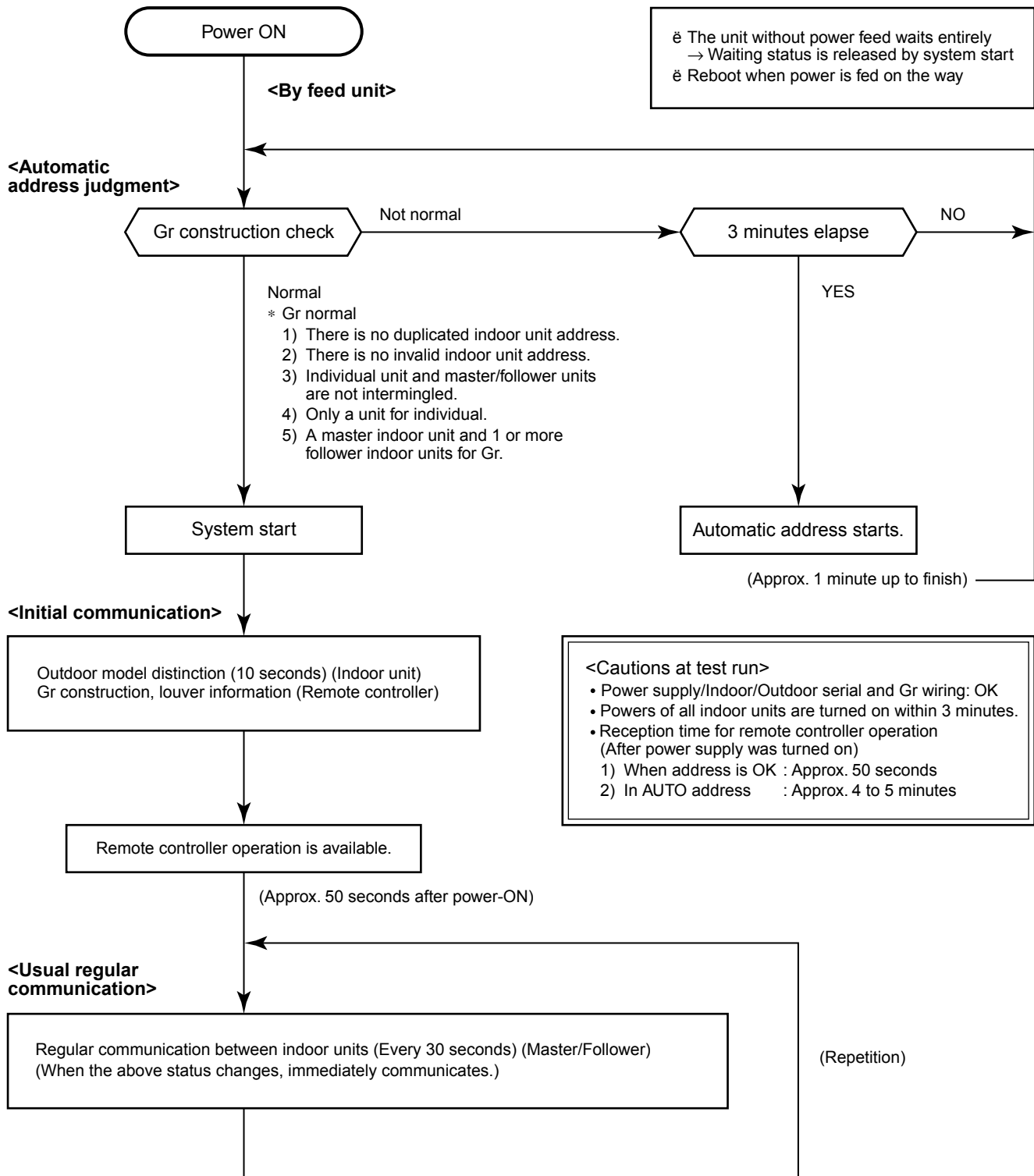

- In a group operation, if the indoor unit which was fed power after judgment of automatic address cannot receive regular communication from the master unit and regular communication on identical pipe within 120 seconds after power was turned on, it reboots (system reset).
 - The operation starts from judgment of automatic address (Gr construction check) again.
(If the address of the master unit was determined in the previous time, the power fed to the master unit and reboot works, the master unit may change though the indoor unit line address is not changed.)

10. ADDRESS SETUP

10-1. Address Setup Procedure

When an outdoor unit and an indoor unit are connected, or when an outdoor unit is connected to each indoor unit respectively in the group operation even if multiple refrigerant lines are provided, the automatic address setup completes with power-ON of the outdoor unit. The operation of the remote controller is not accepted while automatic address works. (Approx. 4 to 5 minutes)

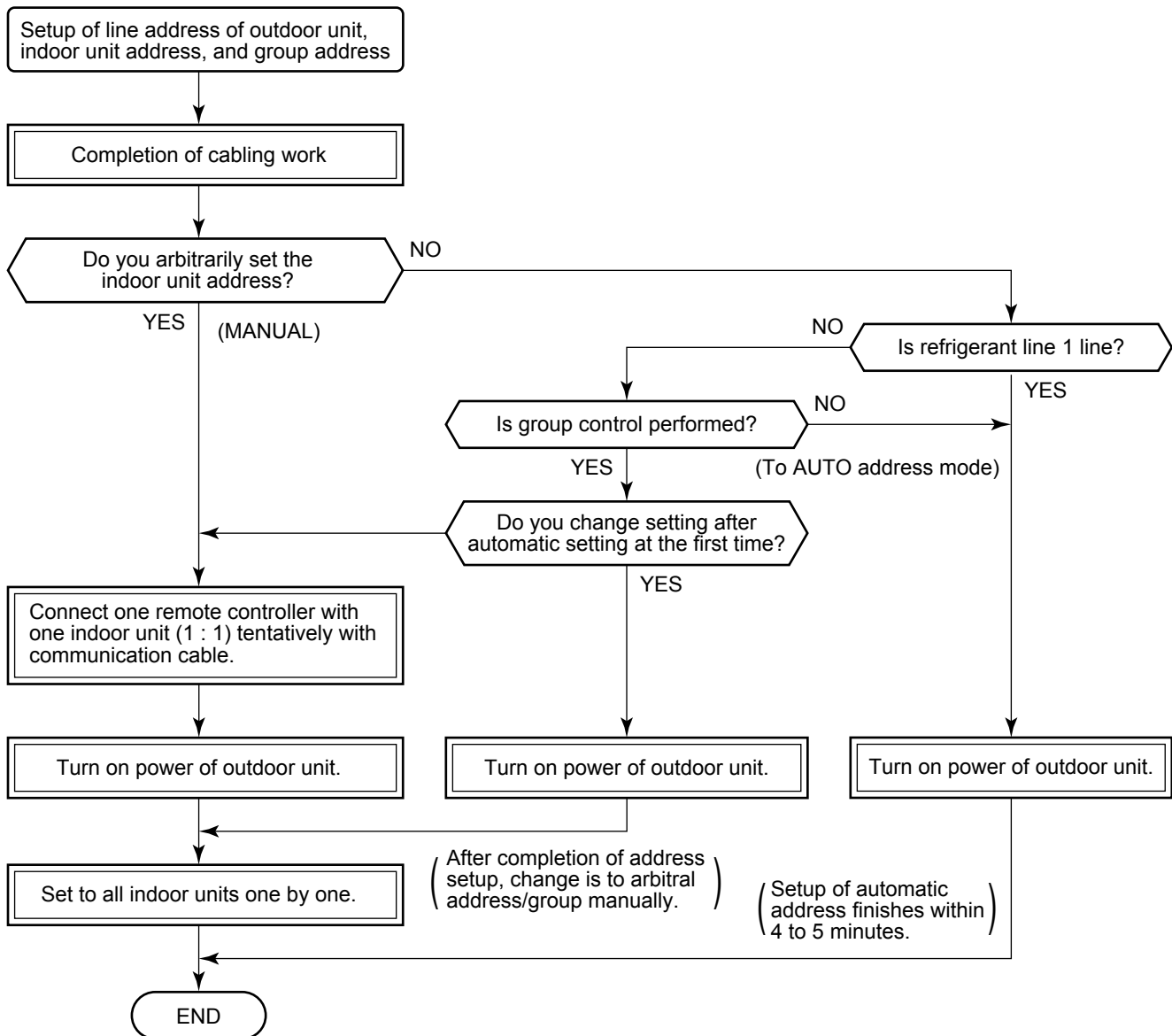

- When the following addresses are not stored in the neutral memory (IC503) on the indoor P.C. board, a test run operation cannot be performed. (Unfixed data at shipment from factory)

	Item code	Data at shipment	Setup data range
Line address	12	0099	0001 (No. 1 unit) to 0064 (No. 64 unit)
Indoor unit address	13	0099	0001 (No. 1 unit) to 0064 (No. 64 unit) Max. value of indoor units in the identical refrigerant line
Group address	14	0099	0000 : Individual (Indoor units which are not controlled in a group) 0001 : Master unit (1 indoor unit in group control) 0002 : Sub unit (Indoor units other than master unit in group control)

10-2. Address Setup & Group Control

<Terminology>

Indoor unit No. : N - n = Outdoor unit line address N (Max. 30) - Indoor unit address n (Max. 64)

Group address : 0 = Single (Not group control)
 1 = Master unit in group control
 2 = Sub unit in group control

Master unit (= 1) : The representative of multiple indoor units in group operation sends/receives signals to/from the remote controllers and sub indoor units.
 (* It has no relation with an indoor unit which communicates serially with the outdoor units.)
 The operation mode and setup temperature range are displayed on the remote controller LCD.
 (Except air direction adjustment of louver)

Sub unit (= 2) : Indoor units other than master unit in group operation
 Basically, sub units do not send/receive signals to/from the remote controllers.
 (Except errors and response to demand of service data)

Header unit (Representative unit)

: This unit communicates with the indoor unit (follower) which serial-communicates with the outdoor units and sends/receives signal (Command from compressor) to/from the outdoor units as the representative of the cycle control in the indoor units of the identical line address within the minimum unit which configures one of the refrigerating cycles of Twin.

Follower unit (Subordinate unit)

: This unit communicates with (Header) indoor unit in the identical line address and performs control synchronized with (Header) indoor unit.
 This unit does not perform the signal send/receive operation with the outdoor units. :
 No judgment for serial signal error.

10-2-1. System Configuration

1. Single

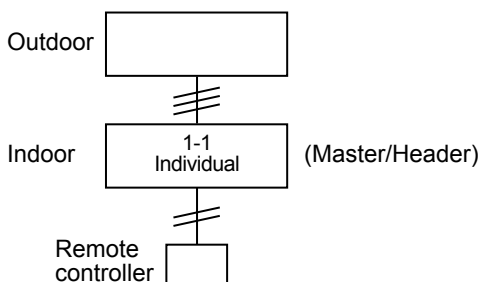

2. Single group operation

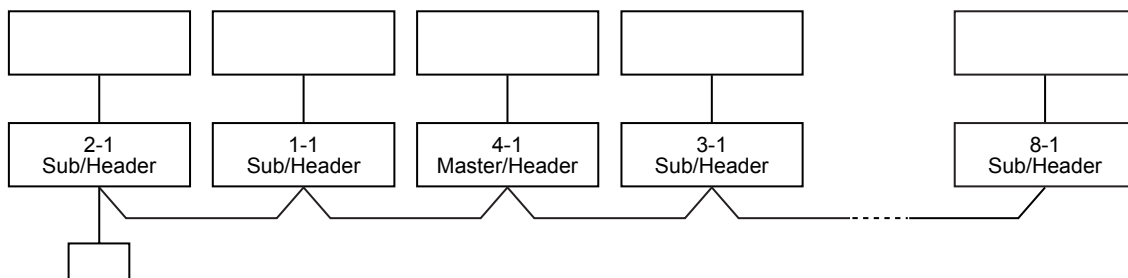

10-2-2. Automatic Address Example from Unset Address (No miswiring)

1. Standard (One outdoor unit)

1) Single

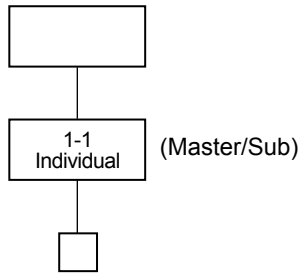

2) Group operation

(Multiple outdoor units = Multiple indoor units only with serial communication)

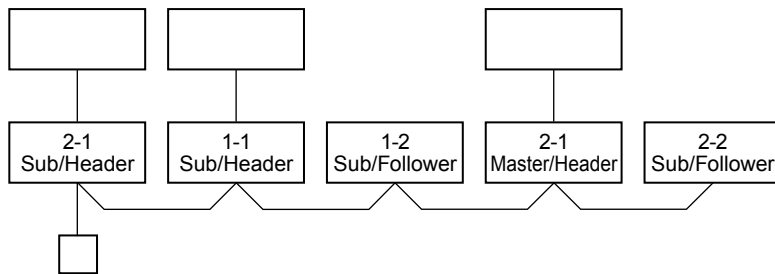

Only turning on source power supply (Automatic completion)

- Header unit: The header unit receives the indoor unit data (thermo status) of the follower (Without identical line address & indoor/outdoor serial) and then finally controls the outdoor compressor matching with its own thermo status.
The header unit sends this command information to the follower unit.
- Follower unit: The follower unit receives the indoor unit data from the header (With identical line address & indoor/outdoor serial) and then performs the thermo operation synchronized with the header unit.
The follower unit sends own thermo ON/OFF demand to the header unit.

(Example)

No. 1-1 header unit sends/receives signal to/from No. 1-2 and No. 1-3 follower units.
(It is not influenced by the line 2 or 3 address indoor unit.)

10-2-3. Automatic Address Example from Unset Address (No miswiring)

- 1. Standard (One outdoor unit)
 - 1) Single

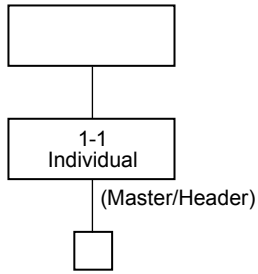

Only turning on source power supply (Automatic completion)

- 2. Group operation
(Multiple outdoor units = Multiple indoor units with serial communication only, without twin)

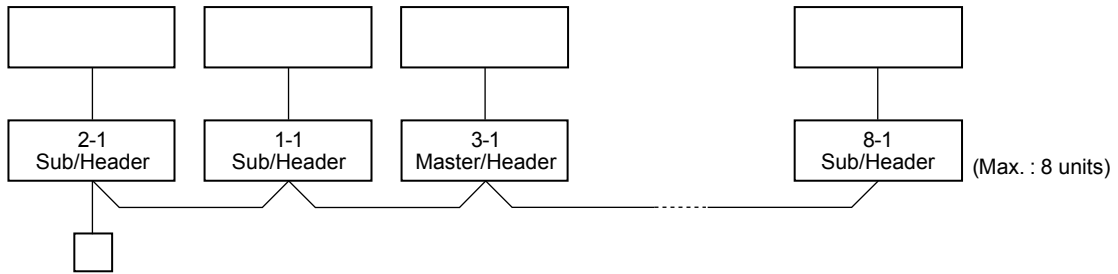

Only turning on source power supply (Automatic completion)

10-3. Remote Controller Wiring

- Strip off approx. 9 mm the wire to be connected.
- For single system, use non polarity, 2 core wire is used for wiring of the remote controller. (0.5 mm² to 2.0 mm² wires)

Wiring diagram

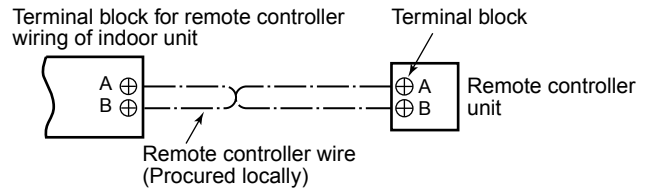

* For details of wiring/installation of the remote controller, refer to the Installation Manual enclosed with the remote controller.

Single system

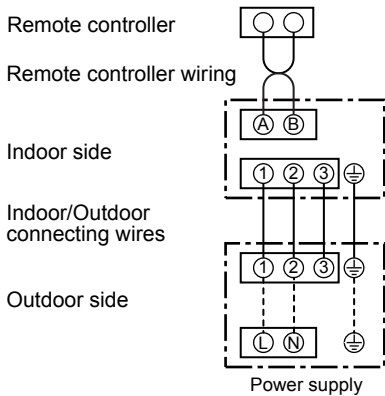

10-4. Address Setup (Manual setting from remote controller)

In case that addresses of the indoor units will be determined prior to piping work after cabling work

- Set an indoor unit per a remote controller.
- Turn on power supply.

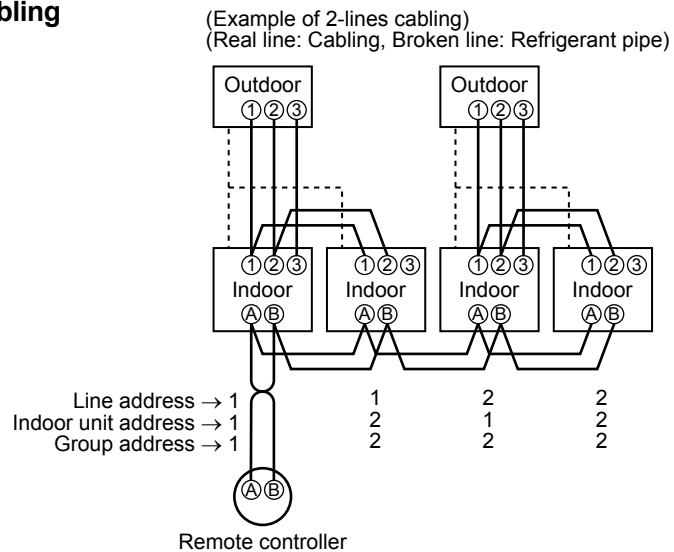

For the above example, perform setting by connecting singly the wired remote controller without remote controller inter-unit cable.

Group address
 Individual : 0000
 Master unit : 0001
 Sub unit : 0002 } In case of group control

- 1** Push **SET** + **CL** + **TEST** buttons simultaneously for 4 seconds or more.
 - 2** (← Line address)
Using the temperature setup **▼** / **▲** buttons, set **12** to the CODE No.
 - 3** Using timer time **▼** / **▲** buttons, set the line address.
 - 4** Push **SET** button. (OK when display goes on.)
 - 5** (← Indoor unit address)
Using the temperature setup **▼** / **▲** buttons, set **13** to the CODE No.
 - 6** Using timer time **▼** / **▲** buttons, set 1 to the line address.
 - 7** Push **SET** button. (OK when display goes on.)
 - 8** (← Group address)
Using the temperature setup **▼** / **▲** buttons, set **14** to the CODE No.
 - 9** Using timer time **▼** / **▲** buttons, set **0000** to Individual, **0001** to Master unit, and **0002** to sub unit.
 - 10** Push **SET** button. (OK when display goes on.)
 - 11** Push **TEST** button.
- Setup completes. (The status returns to the usual stop status.)

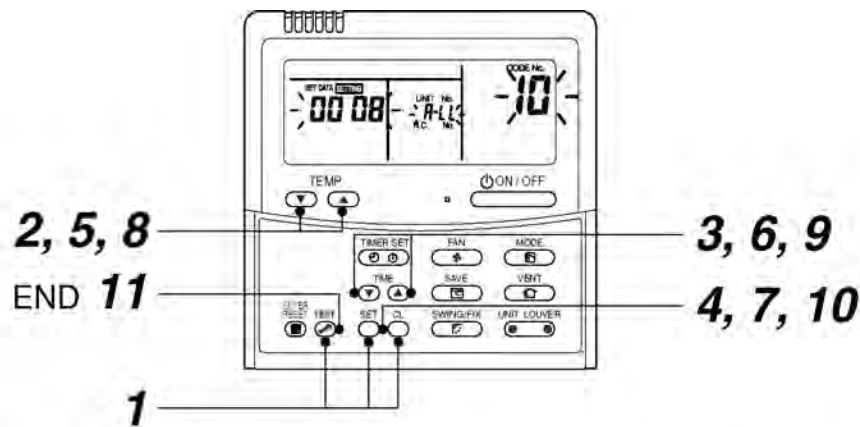

<Operation procedure>

1 → 2 → 3 → 4 → 5 → 6 → 7 → 8 → 9 → 10 → 11 END

10-5. Confirmation of Indoor Unit No. Position

1. To know the indoor unit addresses though position of the indoor unit body is recognized

In case of individual operation (Wired remote controller : indoor unit = 1 : 1)
(Follow to the procedure during operation)

<Procedure>

- 1** Push **ON/OFF** button if the unit stops.
- 2** Push **UNIT LOUVER** button.

Unit No. **1-1** is displayed on LCD.

(It disappears after several seconds.)

The displayed unit No. indicate line address and indoor unit address.

(When other indoor units are connected to the identical remote controller (Group control unit), other unit numbers are also displayed every pushing

UNIT LOUVER button.

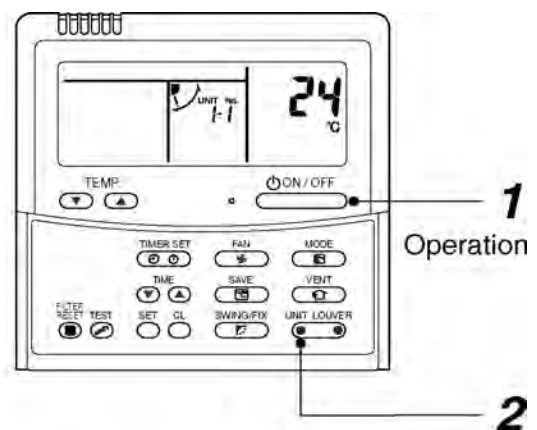

<Operation procedure>





1 → 2 END

2. To know the position of indoor unit body by address

- To confirm the unit No. in the group control
(Follow to the procedure during operation) (in this procedure, the indoor units in group control stop.)

<Procedure>

The indoor unit numbers in the group control are successively displayed, and fan, louver, and drain pump of the corresponding indoor unit are turned on.
(Follow to the procedure during operation)

- 1 Push  and  buttons simultaneously for 4 seconds or more.**
• Unit No. **ALL** is displayed.
• Fans and louvers of all the indoor units in the group control operate.
- 2 Every pushing  button, the unit numbers in the group control are successively displayed.**
• The unit No. displayed at the first time indicates the master unit address.
• Fan and louver of the selected indoor unit only operate.
- 3 Push  button to finish the procedure.**
All the indoor units in the group control stop.

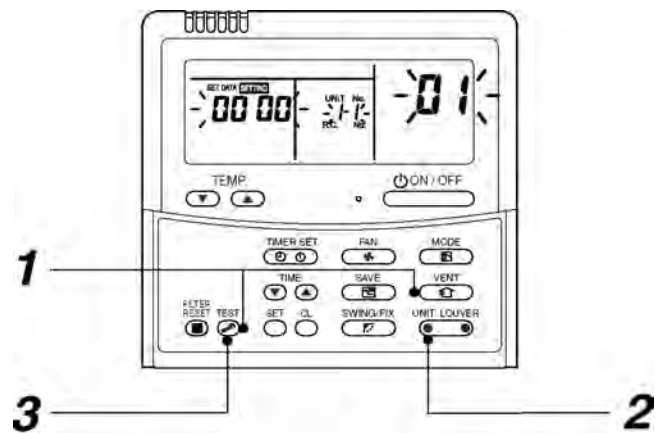

<Operation procedure>

1 → 2 → 3 END

<Maintenance/Check list>

Aiming in environmental preservation, it is strictly recommended to clean and maintain the indoor/outdoor units of the operating air conditioning system regularly to secure effective operation of the air conditioner.

It is also recommended to maintain the units once a year regularly when operating the air conditioner for a long time.

Check periodically signs of rust or scratches, etc. on coating of the outdoor units.

Repair the defective position or apply the rust resisting paint if necessary.

If an indoor unit operates for approx. 8 hours or more per day, usually it is necessary to clean the indoor/outdoor units once three months at least.

These cleaning and maintenance should be carried out by a qualified dealer.

Although the customer has to pay the charge for the maintenance, the life of the unit can be prolonged.

Failure to clean the indoor/outdoor units regularly will cause shortage of capacity, freezing, water leakage or trouble on the compressor.

Part name	Object		Contents of check	Contents of maintenance
	Indoor	Outdoor		
Heat exchanger	○	○	• Blocking with dust, damage check	• Clean it when blocking is found.
Fan motor	○	○	• Audibility for sound	• When abnormal sound is heard
Filter	○	—	• Visual check for dirt and breakage	• Clean with water if dirty • Replace if any breakage
Fan	○	○	• Visual check for swing and balance • Check adhesion of dust and external appearance.	• Replace fan when swinging or balance is remarkably poor. • If a large dust adheres, clean it with brush or water.
Suction/Discharge grille	○	—	• Visual check for dirt and scratch	• Repair or replace it if deformation or damage is found.
Drain pan	○	—	• Check blocking by dust and dirt of drain water.	• Clean drain pan, Inclination check
Face panel, Louver	○	—	• Check dirt and scratch.	• Cleaning/Coating with repair painting
External appearance	—	○	• Check rust and peeling of insulator • Check peeling and floating of coating film	• Coating with repair painting

11. HOW TO EXCHANGE COMPRESSOR

11-1. Exchanging Procedure of Compressor (Outline)

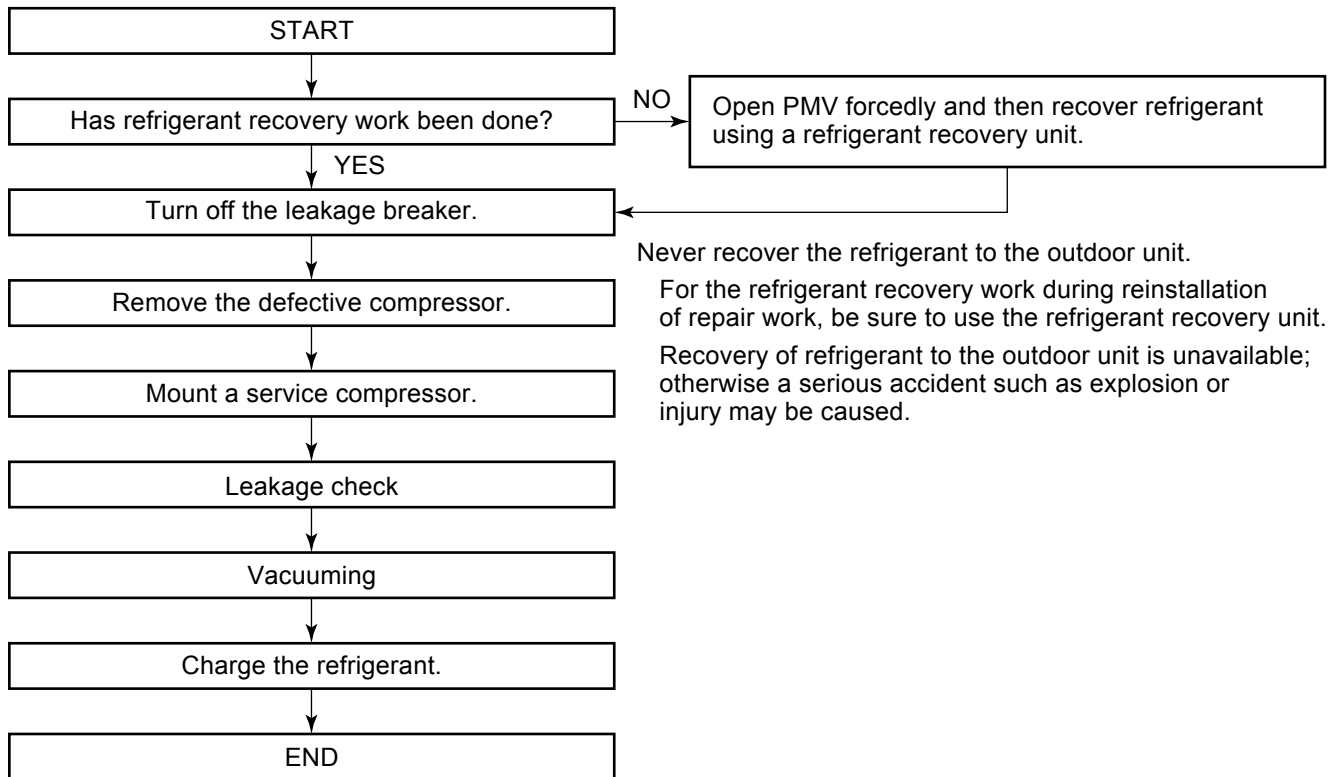



11-2. Exchange of Compressor





For exchange of compressors, refer to (11) Compressor in Section of 13. **Attachments.**

12. DETACHMENTS

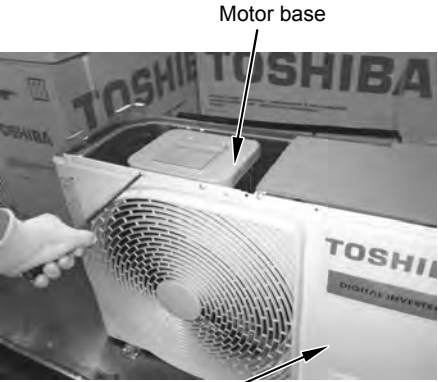
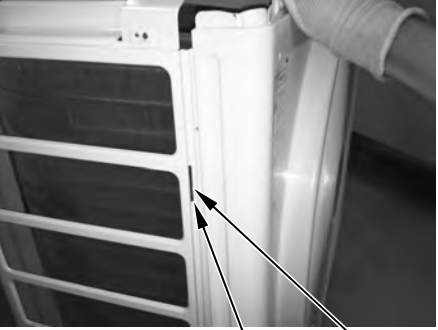
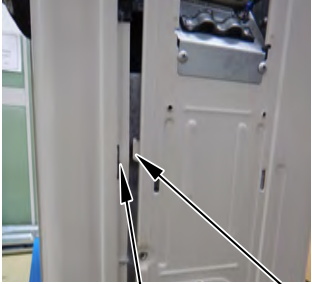
12-1. RAV-GM301AT*P*, GM401AT*P*

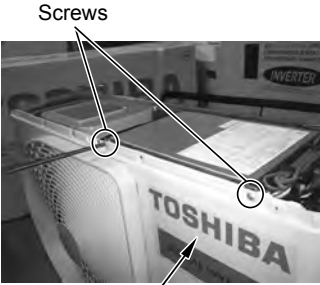
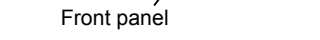
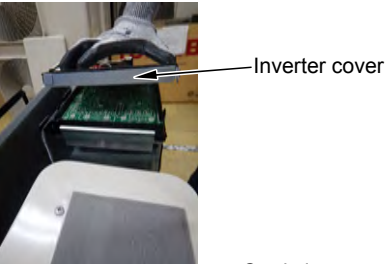
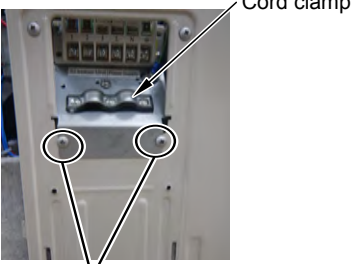

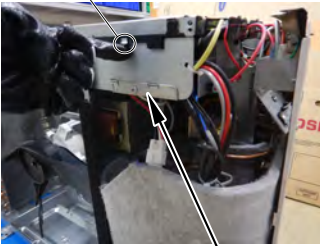
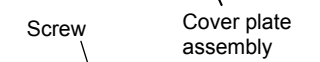
No.	Part name	Procedure	Remarks
①	Common procedure	<hr/> <p style="text-align: center;">CAUTION</p> <p>Never forget to put on the gloves at working time, otherwise an injury will be caused by the parts, etc.</p> <hr/> <p>1. Detachment</p> <ol style="list-style-type: none"> 1) Stop operation of the air conditioner, and turn off the main switch of the breaker for air conditioner. 2) Remove the valve cover. (ST1T Ø4 × 10L, 3 pcs.) <ul style="list-style-type: none"> • After removing screw, remove the valve cover pulling it downward. 3) Remove cord clamp (PT2T Ø4 × 14L, 3 pcs.), and then remove connecting cable. 4) Remove the upper cabinet. (ST1T Ø4 × 10L, 5 pcs.) <ul style="list-style-type: none"> • After taking off screws, remove the upper cabinet pulling it upward. <p>2. Attachment</p> <ol style="list-style-type: none"> 1) Attach the waterproof cover. <hr/> <p style="text-align: center;">CAUTION</p> <p>Be sure to attach a waterproof cover. If it is not attached, there is a possibility that water enters inside of the outdoor unit.</p> <hr/> <ol style="list-style-type: none"> 2) Attach the upper cabinet. (ST1T Ø4 × 10L, 5 pcs.) <ul style="list-style-type: none"> • Hook the rear side of the upper cabinet to claw of the rear cabinet, and then put it on the front cabinet. 3) Perform cabling of connecting cables, and fix with cord clamp. (BT2T Ø4 × 12L, 3 pcs.) 4) Attach the cord clamp. (PT2T Ø4 × 14L, 3 pcs.) 5) Attach the valve cover. (ST1T Ø4 × 10L, 3 pcs.) 	 <p style="text-align: right;">Valve cover</p>  <p style="text-align: right;">Cord clamp</p>  <p style="text-align: right;">Upper cabinet</p> <p style="text-align: right;">Water-proof cover</p> <p style="text-align: right;">Front cabinet</p>

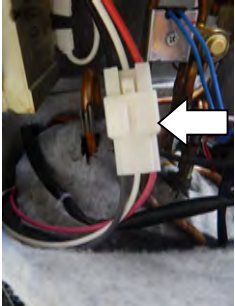

No.	Part name	Procedure	Remarks
②	Front cabinet	<p>1. How to remove</p> <ol style="list-style-type: none"> 1) Perform 1 of ①. 2) Remove the screw between front cabinet and side cabinet (right). (ST1T Ø4 × 10 , 1 pc.) 3) Remove the screw between front cabinet and inverter. (ST1T Ø4 × 10, 2 pcs.) 4) Remove the screw between front cabinet and bottom slab. (ST1T Ø4 × 10, 3 pcs.) 5) Remove the screw between front cabinet and motor base. (ST1T Ø4 × 10, 2 pcs.) <p>Left side of front panel is inserted into side cabinet (left). Remove by pulling the upper part.</p> <p>2. How to install</p> <ol style="list-style-type: none"> 1) Insert front panel's hook into side cabinet (left). 2) Insert side cabinet (left)'s hook into front cabinet's corner hole. 3) Insert the removed screws to their positions. 	  

No.	Part name	Procedure	Remarks
③	Inverter assembly	<p>1. Detachment</p> <ol style="list-style-type: none"> 1) Perform work of item 1 of ① . 2) Take off screws of the upper part of the front cabinet. (ST1T Ø4 ×10L, 2 pcs.) <ul style="list-style-type: none"> • If removing the inverter cover under this condition, P.C. board can be checked. • If there is no space in the upper part of the upper cabinet, perform work of ②. <hr/> <p style="text-align: center;">CAUTION</p> <p>Be careful to check the inverter because high-voltage circuit is incorporated in it.</p> <hr/> <p style="text-align: center;">WARNING</p> <p>Never disassemble the inverter for 1minute after power has been turned off because an electric shock may be caused.</p> <hr/> <ol style="list-style-type: none"> 3) Perform 1 of ②. 4) Take off screw between side cabinet (right) and inverter box (wiring gate side) (ST1T Ø4 × 10, 2 pcs.) 5) Take off screw between partition plate and inverter box. (ST1T Ø4 × 10, 1 pc.) 6) Remove each lead wire type from holder of inverter upper part. 7) Pull upper part of inverter. Here, please cut bundling band that tie each lead wire type. 8) Remove the cover plate assembly. By hold cover plate assembly and pull down from PC board base's hook. 9) Remove connector of each lead wire type. 	 <p>Screws</p>  <p>Front panel</p>  <p>Inverter cover</p>  <p>Cord clamp</p>  <p>Screws</p>  <p>Hook</p>  <p>Screw</p>  <p>Cover plate assembly</p>  <p>Screw</p>

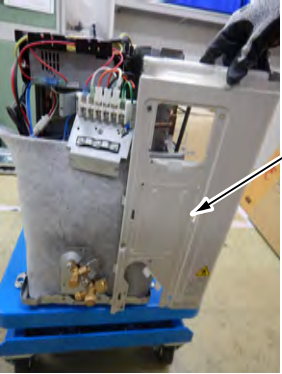
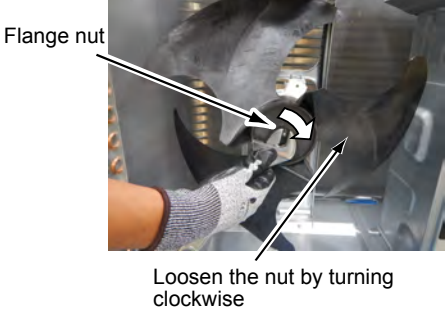
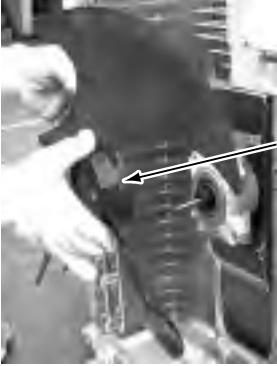
No.	Part name	Procedure	Remarks
③	Inverter assembly	<ul style="list-style-type: none"> • Connector Connection to compressor (3P : Relay connector white) ※ (Warning 1) Reactor (2P : Relay connector white) CN31··· Outdoor fan (3P : white) ※ (Warning 1) CN72··· 4 directional valve (3P : yellow) ※ (Warning 1) CN73··· PMV coil (6P : white) ※ (Warning 1) CN62··· TD sensor (3P : white) CN64··· TS sensor (3P : white) ※ (Warning 1) CN61··· TE sensor (2P : white) ※ (Warning 1) CN63··· TO sensor (2P : white) CN52··· High pressure switch (2P : white) ※ (Warning 1) <p>※ Warning 1) Please remove housing part's lock before removing connectors.</p> <hr/> <p style="text-align: center;">REQUIREMENT</p> <p>As each connector has a lock mechanism, avoid to remove the connector by holding the lead wire, but by holding the connector.</p> <hr/>	 <p>Inverter assembly</p>  <p>Remove the connectors with locking function by pushing the part indicated by the arrow mark.</p>

No.	Part name	Procedure	Remarks
④	Control P.C. board assembly	<p>1) Take off 1 screws (ST1T Ø4 × 10L) that fixed between ASM-COV-WIRING and inverter box. then disengage ASM-COV-WIRING from inverter box.</p> <p>2) Remove P.C.board base's hook (Hook 1, 2, 3, 4), hold P.C.board base, pull inverter box up. Remove lead wire • connector that are connected from control board frame to other parts.</p> <p>1. Lead wire : Connect with terminal block Black, white, orange (single phase), earthed lines (black)··· 1 pc.</p> <p>Please cut the bundling band that tie lead wire connect with terminal block Black, White, Orange with inverter box(metal plate).</p> <p>※ Warning 1) Please remove housing part's lock before removing connectors.</p> <p>3) Remove inverter box from base P.C.board base by disengage P.C.board base's hook (Hook1,2,3,4) and pull inverter box up.</p> <p>4) Remove control board frame from PC board base. (Remove while heat sink is still attached to control board frame)</p> <p>5) Take off 5 screws that connect heat sink and control board frame.</p> <p>6) Install new control board frame.</p> <p>Warning 2) When install new control board frame, please correctly insert the board. Make sure to install that heat sink touch metal plate.</p>	<p>Sub board base</p> <p>Power line</p> <p>Remove earth screw</p> <p>Hook 1, 2</p> <p>Hook 4, 3</p> <p>Control board frame Inverter box (metal plate)</p> <p>PC board base</p> <p>PC board base</p> <p>Control board frame</p>

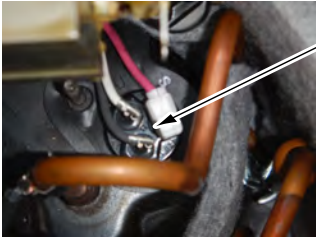
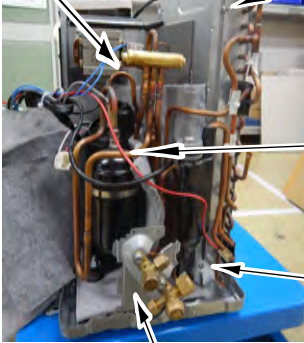
No.	Part name	Procedure	Remarks
⑤	Rear cabinet	1) Perform works of items 1 of ① and ②, ③. 2) Take off fixed screws for the bottom plate. (ST1T Ø4 × 10L, 2 pcs.) 3) Take off fixed screw for the valve mounting plate. (ST1T Ø4 × 10L, 2 pcs.)	
⑥	Fan motor	1) Perform works of items 1 of ① and ② . 2) Take off the flange nut fixing the fan motor and the propeller. • Turning it clockwise, the flange nut can be loosened. (To tighten the flange nut, turn counterclockwise.) 3) Remove the propeller fan. 4) Disconnect the connector for fan motor from the inverter. 5) Take off the fixing screws (3 pcs.) holding by hands so that the fan motor does not fall. NOTE: Tighten the flange nut with torque 4.9Nm (50kgf/cm).	  

No.	Part name	Procedure	Remarks
⑦	Compressor	<p>1) Perform works of items 1 of ① and ②, ③, ⑤.</p> <p>2) Discharge refrigerant gas.</p> <p>3) Remove the partition plate. (ST1T Ø4 × 10L, 3 pcs.)</p> <p>4) Remove the terminal covers of the compressor, and disconnect lead wires of the compressor and the compressor thermo assembly from the terminal.</p> <p>5) Take off the soundproof plate.</p> <p>6) Remove pipes connected to the compressor with a burner.</p> <hr/> <p style="text-align: center;">CAUTION</p> <hr/> <p>Pay attention to that flame does not involve 4-way valve or PMV. (If doing so, a malfunction may be caused.)</p> <hr/> <p>7) Take off the fixing screws of the bottom plate and heat exchanger. (ST1T Ø4 × 10L)</p> <p>8) Take off the fixing screws of the plate fix valve to the bottom plate. (ST1T Ø4 × 10L, 2 pcs.)</p> <p>9) Pull upward the refrigerating cycle.</p> <p>10) Take off nut fixing the compressor to the bottom place.</p> <hr/> <p style="text-align: center;">CAUTION</p> <hr/> <p>When reconnecting the lead wires to the compressor terminals after replacement of the compressor, be sure to caulk the Faston terminal without loosening.</p> <hr/>	 <p>Partition plate</p>  <p>Compressor lead</p> <p>Remove (Discharge pipe)</p>  <p>Screw</p> <p>Remove (Suction pipe)</p> <p>Screw</p> <p>Plate fix Valve</p>
⑧	Reactor	<p>1) Perform works of item 1 of ①, ② and ③.</p> <p>2) Remove partition plate (ST1T Ø4 × 10L, 3 pcs.)</p> <p>3) Take off screw attached to reactor (ST1T Ø4 × 10L, 5 pcs.)</p>	

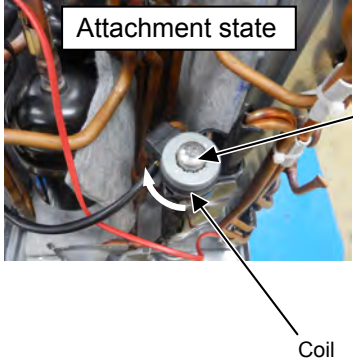
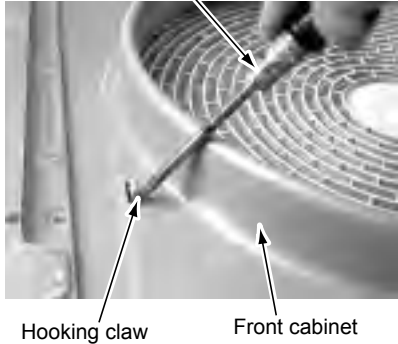
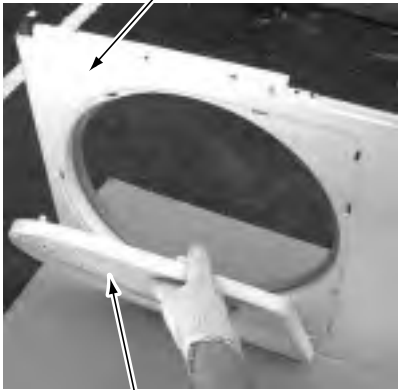
No.	Part name	Procedure	Remarks
⑨	Pulse Motor Valve (PMV) coil	<p>1. Detachment</p> <ol style="list-style-type: none"> 1) Perform works of items ① and ②. 2) Release the coil from the concavity by turning it, and remove coil from the PMV. <p>2. Attachment</p> <ol style="list-style-type: none"> 1) Put the coil deep into the bottom position. 2) Fix the coil firmly by turning it to the concavity. 	
⑩	Fan guard	<p>1. Detachment</p> <ol style="list-style-type: none"> 1) Perform works of items 1 of ① and ②. 2) Remove the front cabinet, and put it down so that fan guard side directs downward. <hr/> <p style="text-align: center;">CAUTION</p> <p>Perform works on a corrugated cardboard, cloth, etc. to prevent flaw on the product.</p> <hr/> <ol style="list-style-type: none"> 3) Remove the hooking claws by pushing with minus screwdriver along with the arrow mark in the right figure, and remove the fan guard. <p>2. Attachment</p> <ol style="list-style-type: none"> 1) Insert claws of the fan guard in the hole of the front cabinet. Push the hooking claws (10 positions) with hands and then fix the claws. <hr/> <p style="text-align: center;">CAUTION</p> <p>All the attaching works have completed. Check that all the hooking claws are fixed to the specified positions.</p> <hr/>	 

13. EXPLODED VIEWS AND PARTS LIST

13-1. RAV-GM301ATP-E, RAV-GM301ATP-TR, RAV-GM301ATP-NZ

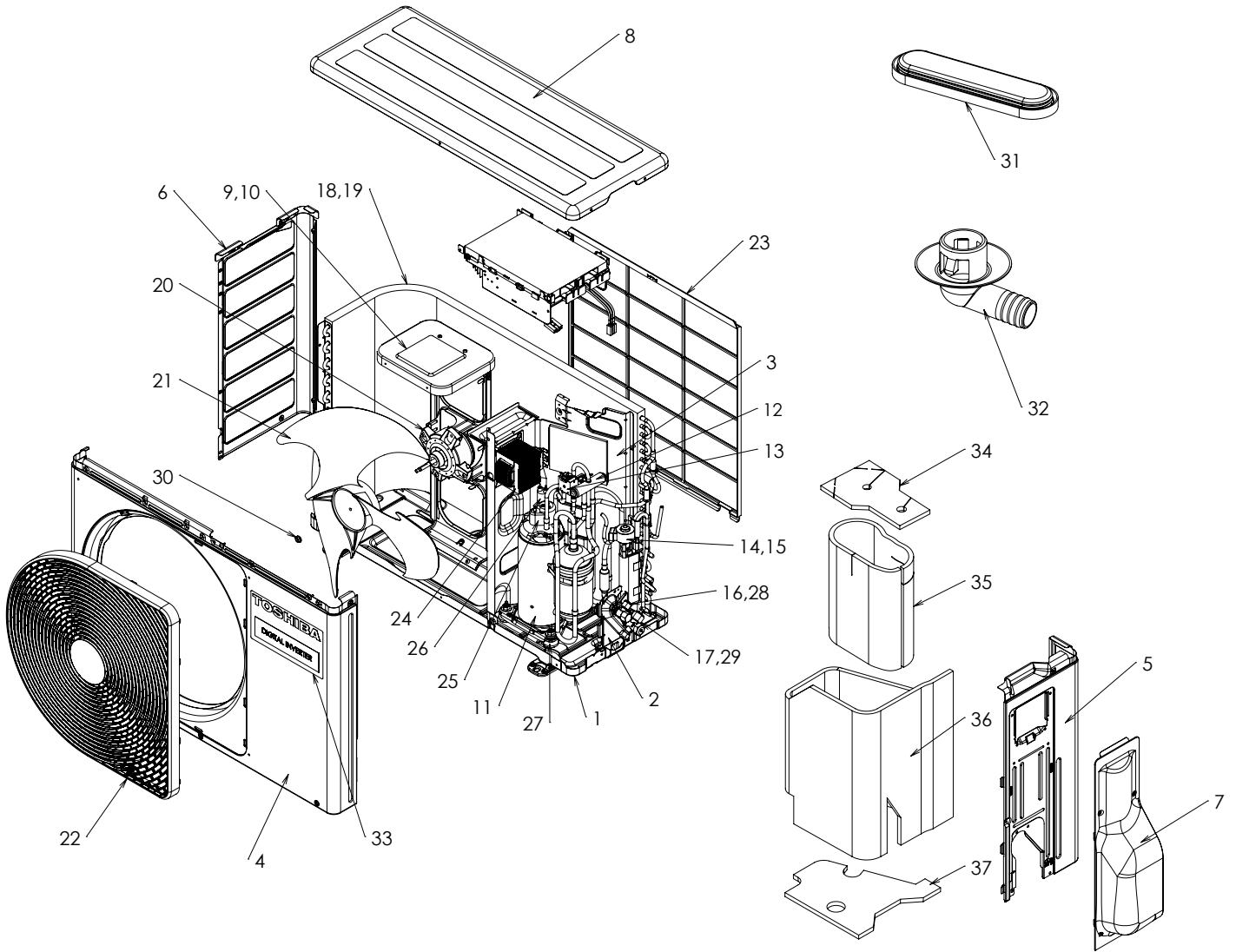

Ref.No.	Parts No.	Description	RAV-		
			GM301ATP-E	GM301ATP-TR	GM301ATP-NZ
1	43T42352	ASM-COAT-BASE	1	1	1
2	43T00653	ASM-COAT-P-F-PV	1	1	1
3	43T00742	PARTITION ASSEMBLY	1	1	1
4	43T00605	ASM-CABI-F-S	1	1	1
5	43T00743	RIGHT CABINET ASSEMBLY	1	1	1
6	43T00602	ASM-COAT-C-S-L	1	1	1
7	43T19352	ASM-COVER-PV	1	1	1
8	43T00604	ASM-COAT-CABI-U	1	1	1
9	43T39348	ASM-M-BASE	1	1	1
11	43T41521	COMPRESSOR	1	1	1
12	43T46367	4 WAY VALVE	1	1	1
13	43T63327	COIL-4WAY	1	1	1
14	43T46469	BODY PMV	1	1	1
15	43T63360	COIL PMV	1	1	1
16	43T46435	VALVE; PACKED 6.35 DIA	1	1	1
17	43T46503	VALVE ; PACKED 9.52 DIA	1	1	1
18	43T43559	CONDENSER ASSEMBLY	1	1	1
20	43T21460	FAN MOTOR	1	1	1
21	43T20365	PROPELLER FAN	1	1	1
22	43T19364	FAN GUARD	1	1	1
23	43T19331	FIN GUARD	1	1	1
24	43T58309	REACTOR	1	1	1
25	43T60420	ASM-COMP-LEAD	1	1	1
26	43T63369	SWITCH, PRESSURE	1	1	1
27	43T49327	CUSHION,RUBBER	3	3	3
28	43T47403	BONNET, 6.35 DIA	1	1	1
29	43T47404	BONNET, 9.52 DIA	1	1	1
30	43T39346	NUT FLANGE	1	1	1
31	43089160	CAP, WATERPROOF	2	2	2
32	43T79305	DRAIN NIPPLE	1	1	1
33	43T85553	MARK-T	1	1	1
34	43T04416	SOUND INSULATION(UP)	1	1	1
35	43T04355	SOUND INSULATION(IS)	1	1	1
36	43T04332	S-INSU-OUT	1	1	1
37	43T04356	SOUND INSULATION(DN)	1	1	1

<Inverter assembly GM30>

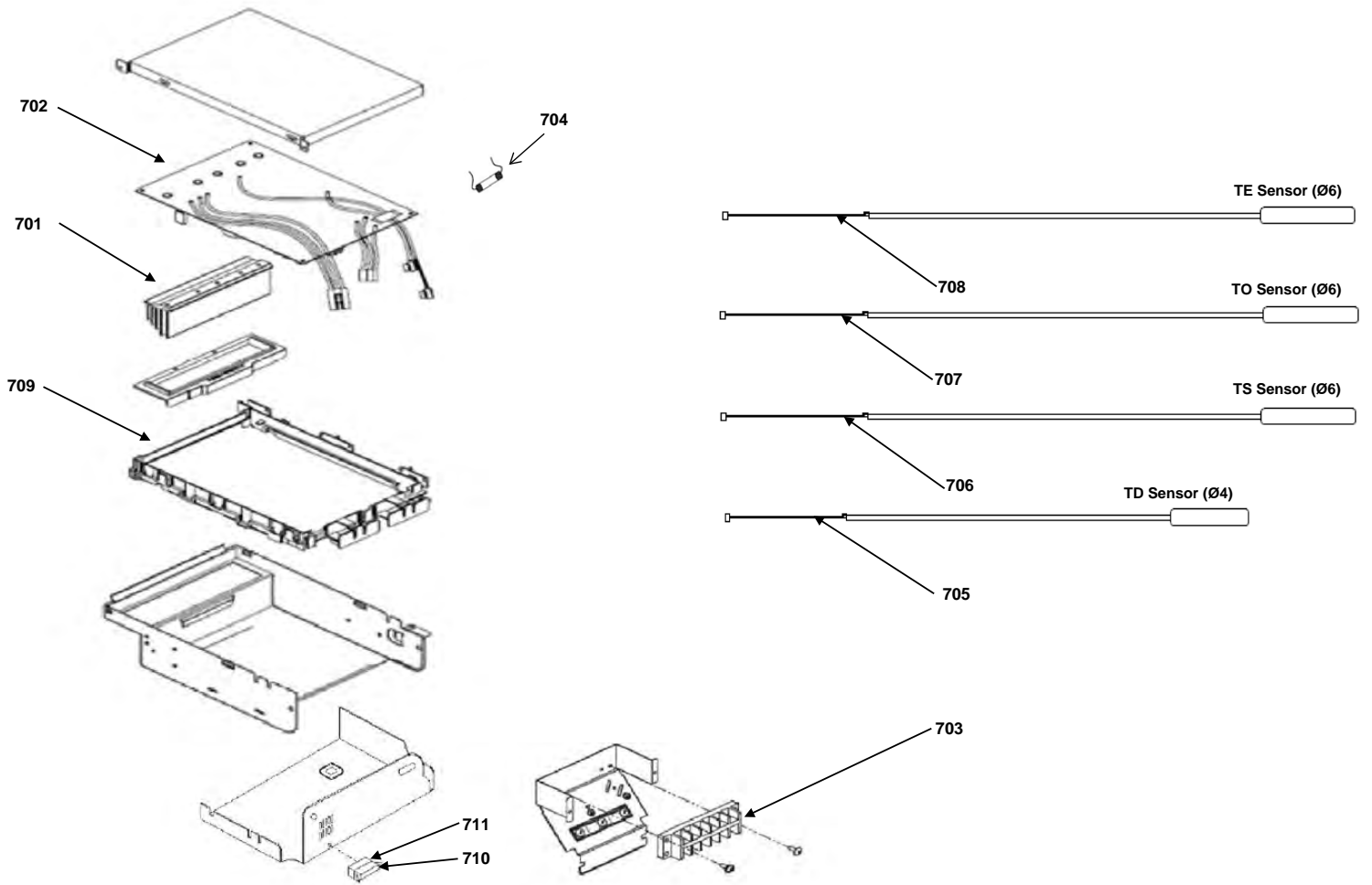

Ref.No.	Parts No.	Description	RAV-		
			GM301ATP-E	GM301ATP-TR	GM301ATP-NZ
701	43T62351	HEATSINK	1	1	1
702	43T6W748	PC BOARD ASSY	1	1	1
703	43T60384	TERMINAL-6P	1	1	1
704	43T60326	FUSE	1	1	1
705	43T50369	TEMPERATURE SENSOR	1	1	1
706	43T50336	TEMPERATURE SENSOR	1	1	1
707	43T50370	TEMPERATURE SENSOR	1	1	1
708	43T50371	TEMPERATURE SENSOR	1	1	1
709	43T62313	PC PLATE BASE	1	1	1
710	43T60463	FUSE	1	1	1
711	43T60425	FUSE HOLDER	1	1	1

Ref.No.	Parts No.	Description	RAV-
			GM301ATJP-E
1	43T42352	ASM-COAT-BASE	1
2	43T00653	ASM-COAT-P-F-PV	1
3	43T00742	PARTITION ASSEMBLY	1
4	43T00605	ASM-CABI-F-S	1
5	43T00743	RIGHT CABINET ASSEMBLY	1
6	43T00602	ASM-COAT-C-S-L	1
7	43T19352	ASM-COVER-PV	1
8	43T00604	ASM-COAT-CABI-U	1
10	43T39347	ASM-M-BASE	1
11	43T41521	COMPRESSOR	1
12	43T46367	4 WAY VALVE	1
13	43T63327	COIL-4WAY	1
14	43T46469	BODY PMV	1
15	43T63360	COIL PMV	1
16	43T46435	VALVE; PACKED 6.35 DIA	1
17	43T46503	VALVE ; PACKED 9.52 DIA	1
19	43T43587	CONDENSER ASSEMBLY	1
20	43T21460	FAN MOTOR	1
21	43T20365	PROPELLER FAN	1
22	43T19364	FAN GUARD	1
23	43T19331	FIN GUARD	1
24	43T58309	REACTOR	1
25	43T60420	ASM-COMP-LEAD	1
26	43T63369	SWITCH, PRESSURE	1
27	43T49327	CUSHION,RUBBER	3
28	43T47403	BONNET, 6.35 DIA	1
29	43T47404	BONNET, 9.52 DIA	1
30	43T39346	NUT FLANGE	1
31	43089160	CAP, WATERPROOF	2
32	43T79305	DRAIN NIPPLE	1
33	43T85553	MARK-T	1
34	43T04416	SOUND INSULATION(UP)	1
35	43T04355	SOUND INSULATION(IS)	1
36	43T04332	S-INSU-OUT	1
37	43T04356	SOUND INSULATION(DN)	1

<Inverter assembly GM30>

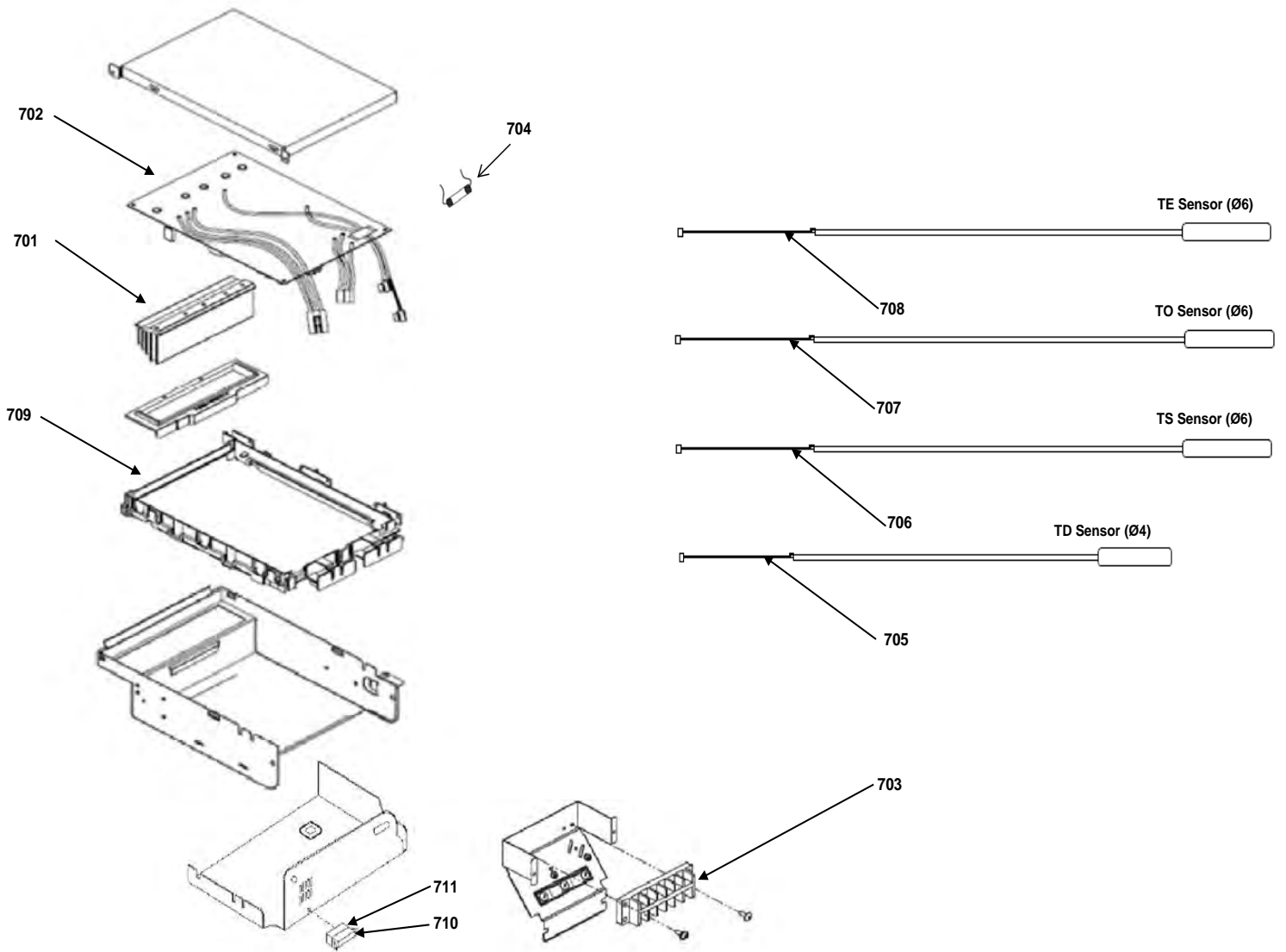

Ref.No.	Parts No.	Description	RAV-
			GM301ATJP-E
701	43T62351	HEATSINK	1
702	43T6W748	PC BOARD ASSY	1
703	43T60384	TERMINAL-6P	1
704	43T60326	FUSE	1
705	43T50369	TEMPERATURE SENSOR	1
706	43T50336	TEMPERATURE SENSOR	1
707	43T50370	TEMPERATURE SENSOR	1
708	43T50371	TEMPERATURE SENSOR	1
709	43T62313	PC PLATE BASE	1
710	43T60463	FUSE	1
711	43T60425	FUSE HOLDER	1

13-3. RAV-GM401ATP-E, RAV-GM401ATP-TR, RAV-GM401ATP-NZ

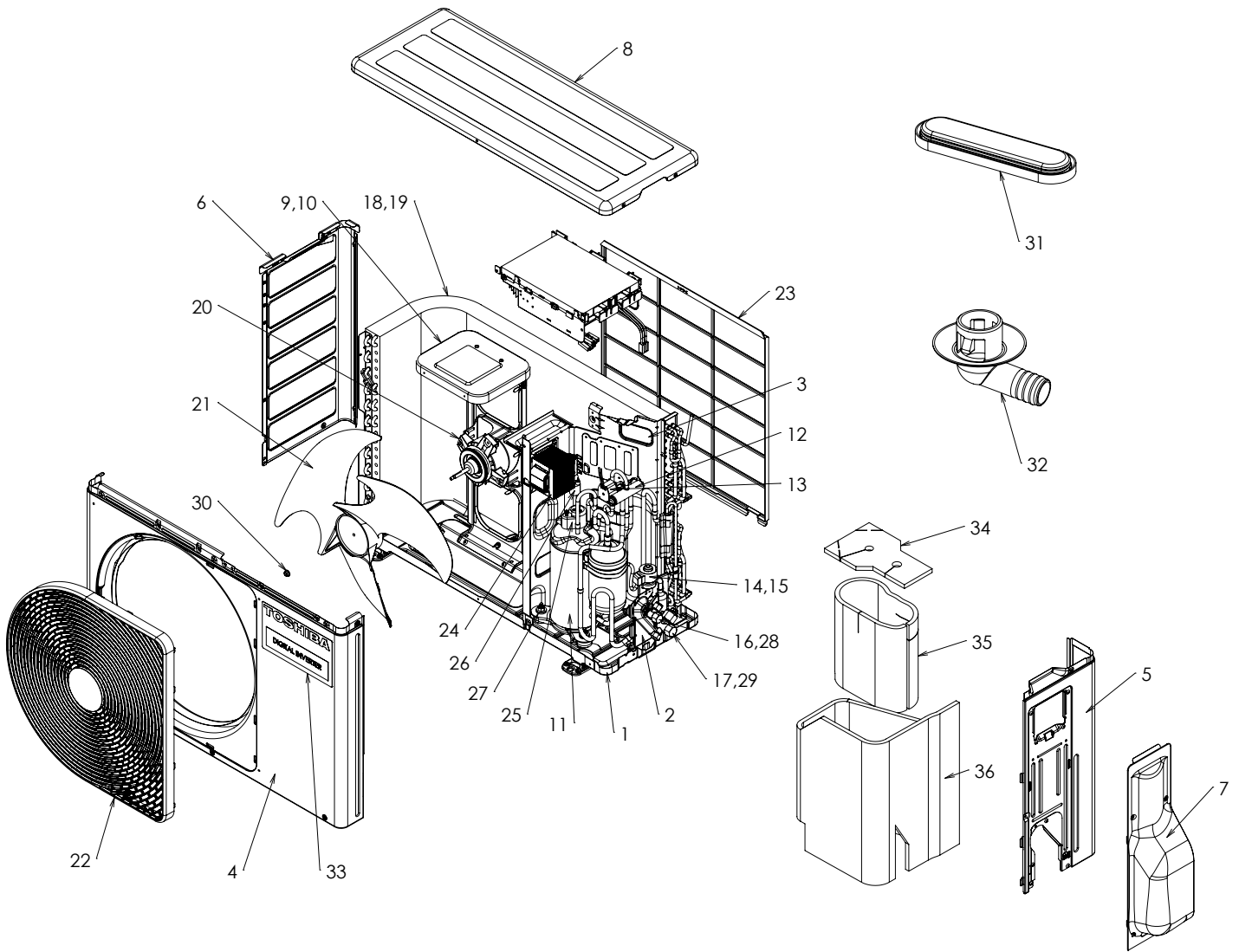

Ref.No.	Parts No.	Description	RAV-		
			GM401ATP-E	GM401ATP-TR	GM401ATP-NZ
1	43T42352	ASM-COAT-BASE	1	1	1
2	43T00653	ASM-COAT-P-F-PV	1	1	1
3	43T00742	PARTITION ASSEMBLY	1	1	1
4	43T00605	ASM-CABI-F-S	1	1	1
5	43T00743	RIGHT CABINET ASSEMBLY	1	1	1
6	43T00602	ASM-COAT-C-S-L	1	1	1
7	43T19352	ASM-COVER-PV	1	1	1
8	43T00604	ASM-COAT-CABI-U	1	1	1
9	43T39348	ASM-M-BASE	1	1	1
11	43T41522	COMPRESSOR	1	1	1
12	43T46367	4 WAY VALVE	1	1	1
13	43T63327	COIL-4WAY	1	1	1
14	43T46469	BODY PMV	1	1	1
15	43T63360	COIL PMV	1	1	1
16	43T46435	VALVE; PACKED 6.35 DIA	1	1	1
17	43T46461	VALVE; PACKED 12.7 DIA	1	1	1
18	43T43561	CONDENSER ASSEMBLY	1	1	1
20	43T21460	FAN MOTOR	1	1	1
21	43T20365	PROPELLER FAN	1	1	1
22	43T19364	FAN GUARD	1	1	1
23	43T19331	FIN GUARD	1	1	1
24	43T58309	REACTOR	1	1	1
25	43T60420	ASM-COMP-LEAD	1	1	1
26	43T63369	SWITCH, PRESSURE	1	1	1
27	43T49327	CUSHION,RUBBER	3	3	3
28	43T47403	BONNET, 6.35 DIA	1	1	1
29	43T47405	BONNET, 12.7 DIA	1	1	1
30	43T39346	NUT FLANGE	1	1	1
31	43089160	CAP, WATERPROOF	2	2	2
32	43T79305	DRAIN NIPPLE	1	1	1
33	43T85553	MARK-T	1	1	1
34	43T04416	SOUND INSULATION(UP)	1	1	1
35	43T04355	SOUND INSULATION(IS)	1	1	1
36	43T04332	S-INSU-OUT	1	1	1

<Inverter assembly GM40>

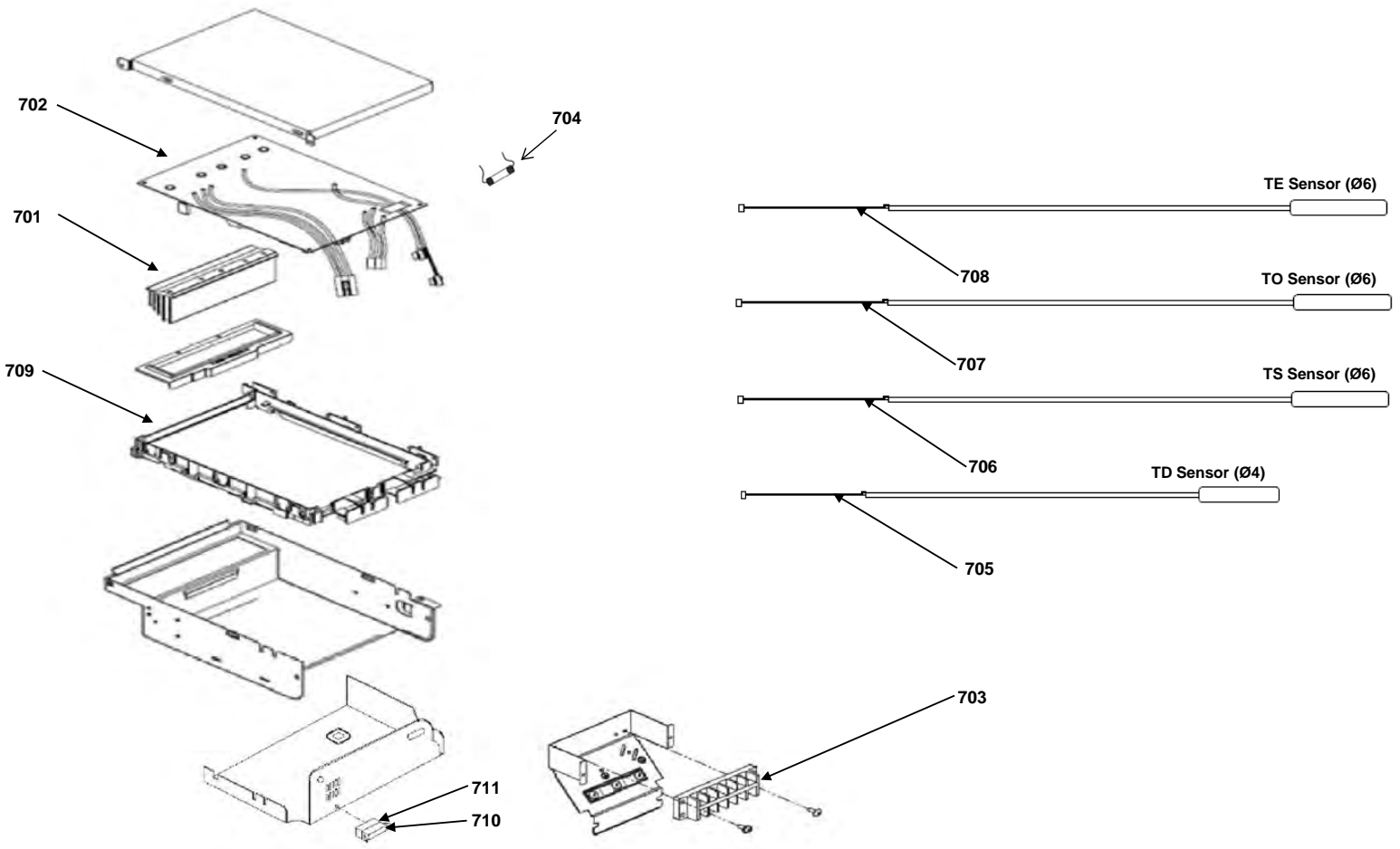

Ref.No.	Parts No.	Description	RAV-		
			GM401ATP-E	GM401ATP-TR	GM401ATP-NZ
701	43T62351	HEATSINK	1	1	1
702	43T6W749	PC BOARD ASSY	1	1	1
703	43T60384	TERMINAL-6P	1	1	1
704	43T60326	FUSE	1	1	1
705	43T50369	TEMPERATURE SENSOR	1	1	1
706	43T50336	TEMPERATURE SENSOR	1	1	1
707	43T50370	TEMPERATURE SENSOR	1	1	1
708	43T50371	TEMPERATURE SENSOR	1	1	1
709	43T62313	PC PLATE BASE	1	1	1
710	43T60463	FUSE	1	1	1
711	43T60425	FUSE HOLDER	1	1	1

13-4. RAV-GM401ATJP-E

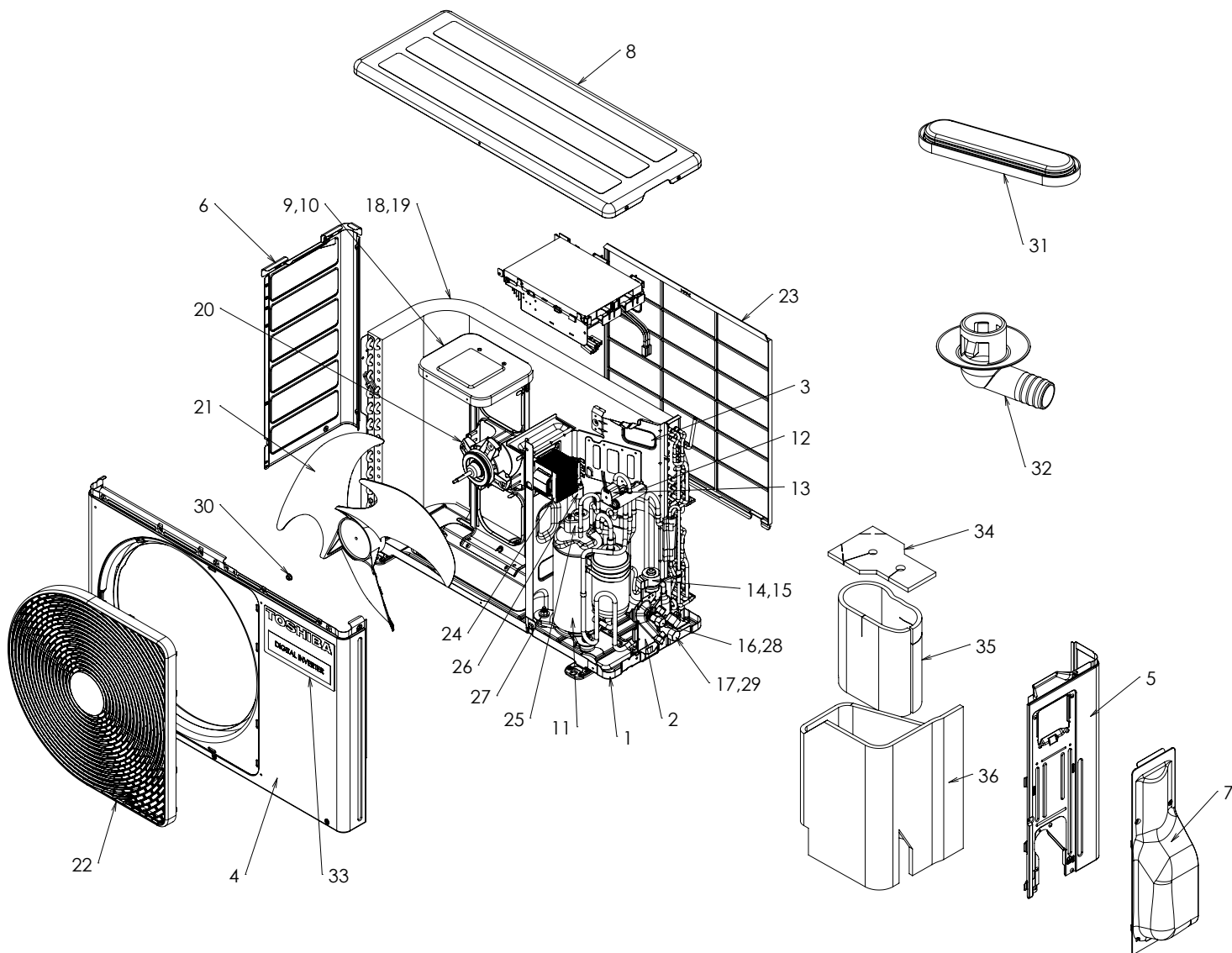

Ref.No.	Parts No.	Description	RAV-
			GM401ATJP-E
1	43T42352	ASM-COAT-BASE	1
2	43T00653	ASM-COAT-P-F-PV	1
3	43T00742	PARTITION ASSEMBLY	1
4	43T00605	ASM-CABI-F-S	1
5	43T00743	RIGHT CABINET ASSEMBLY	1
6	43T00602	ASM-COAT-C-S-L	1
7	43T19352	ASM-COVER-PV	1
8	43T00604	ASM-COAT-CABI-U	1
9	43T39348	ASM-M-BASE	1
11	43T41522	COMPRESSOR	1
12	43T46367	4 WAY VALVE	1
13	43T63327	COIL-4WAY	1
14	43T46469	BODY PMV	1
15	43T63360	COIL PMV	1
16	43T46435	VALVE; PACKED 6.35 DIA	1
17	43T46461	VALVE; PACKED 12.7 DIA	1
18	43T43561	CONDENSER ASSEMBLY	1
20	43T21460	FAN MOTOR	1
21	43T20365	PROPELLER FAN	1
22	43T19364	FAN GUARD	1
23	43T19331	FIN GUARD	1
24	43T58309	REACTOR	1
25	43T60420	ASM-COMP-LEAD	1
26	43T63369	SWITCH, PRESSURE	1
27	43T49327	CUSHION,RUBBER	3
28	43T47403	BONNET, 6.35 DIA	1
29	43T47405	BONNET, 12.7 DIA	1
30	43T39346	NUT FLANGE	1
31	43089160	CAP, WATERPROOF	2
32	43T79305	DRAIN NIPPLE	1
33	43T85553	MARK-T	1
34	43T04416	SOUND INSULATION(UP)	1
35	43T04355	SOUND INSULATION(IS)	1
36	43T04332	S-INSU-OUT	1

<Inverter assembly GM40>

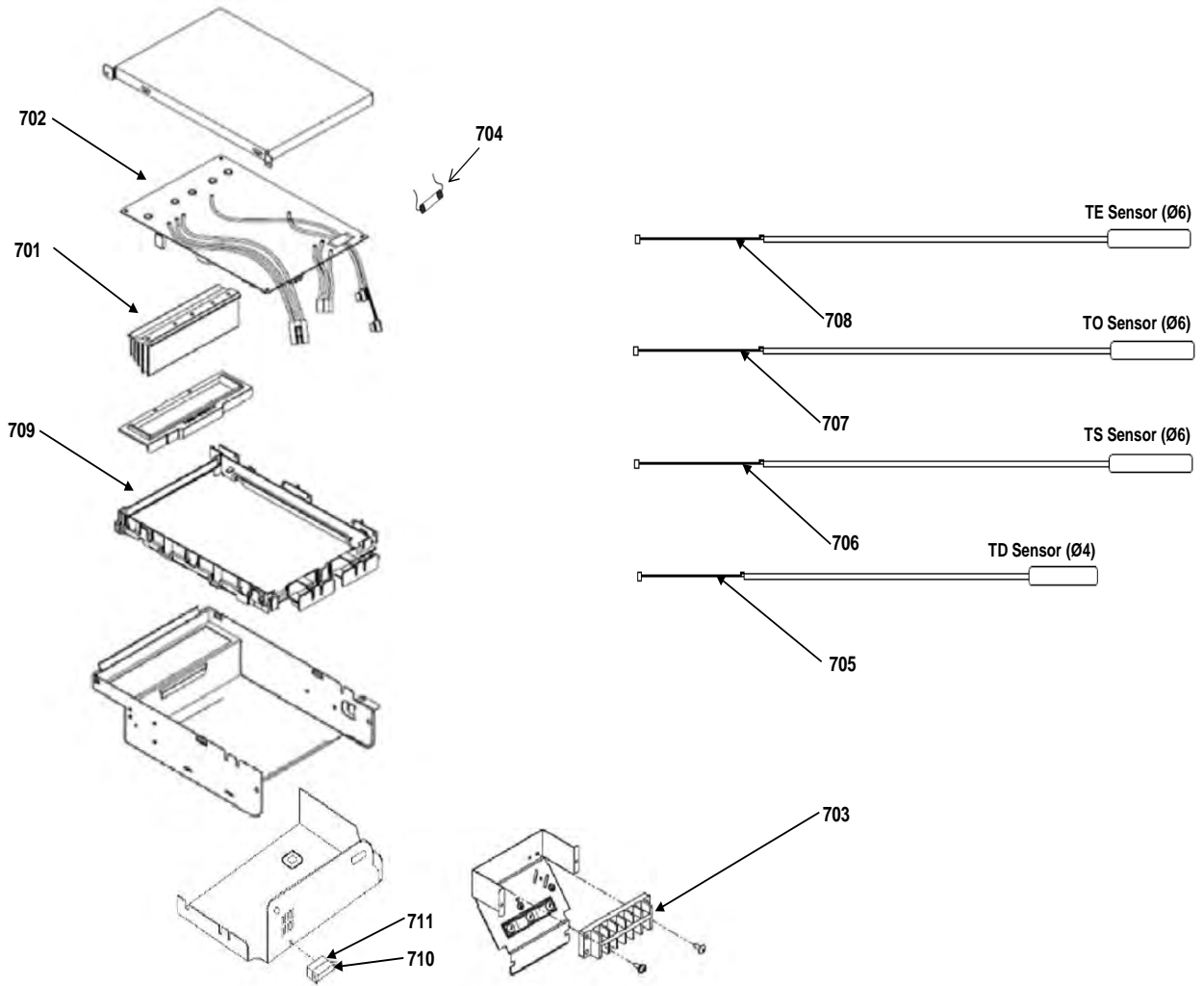

Ref.No.	Parts No.	Description	RAV-
			GM401ATJP-E
701	43T62351	HEATSINK	1
702	43T6W749	PC BOARD ASSY	1
703	43T60384	TERMINAL-6P	1
704	43T60326	FUSE	1
705	43T50369	TEMPERATURE SENSOR	1
706	43T50336	TEMPERATURE SENSOR	1
707	43T50370	TEMPERATURE SENSOR	1
708	43T50371	TEMPERATURE SENSOR	1
709	43T62313	PC PLATE BASE	1
710	43T60463	FUSE	1
711	43T60425	FUSE HOLDER	1

WARNINGS ON REFRIGERANT LEAKAGE

Check of Concentration Limit

The room in which the air conditioner is to be installed requires a design that in the event of refrigerant gas leaking out, its concentration will not exceed a set limit.

The refrigerant R32 which is used in the air conditioner is safe, without the toxicity or combustibility of ammonia, and is not restricted by laws to be imposed which protect the ozone layer. However, since it contains more than air, it poses the risk of suffocation if its concentration should rise excessively. Suffocation from leakage of R32 is almost non-existent.

If a conditioner system is to be installed in a small room, select a suitable model and installation procedure so that if the refrigerant accidentally leaks out, its concentration does not reach the limit (and in the event of an emergency, measures can be made before injury can occur).

In a room where the concentration may exceed the limit, create an opening with adjacent rooms, or install mechanical ventilation combined with a gas leak detection device.

The concentration is as given below.

$$\frac{\text{Total amount of refrigerant (kg)}}{\text{Min. volume of the indoor unit installed room (m}^3\text{)}} \leq \text{Concentration limit (kg/m}^3\text{)}$$

Refrigerant concentration limit shall be in accordance with local regulations.

TOSHIBA CARRIER (THAILAND) CO., LTD.

**144/9 MOO 5, BANGKADI INDUSTRIAL PARK, TIVANON ROAD, TAMBOL BANGKADI,
AMPHUR MUANG, PATHUMTHANI 12000, THAILAND.**